

**ANCIENT ARCHITECTURE IN VIRTUAL REALITY  
DOES IMMERSION REALLY AID LEARNING?**

by

Jeffrey Jacobson

BA, Computer Science, University of Texas, 1986

MS, Information Science, University of Pittsburgh, 1997

Submitted to the Graduate Faculty of  
Information Sciences in partial fulfillment  
of the requirements for the degree of  
Doctor of Philosophy

University of Pittsburgh

2008

UNIVERSITY OF PITTSBURGH  
Department of Information Sciences

This dissertation was presented

by

Jeffrey Jacobson

It was defended on

January 29th, 2008

and approved by

Dr. Peter Brusilovsky, Associate Professor, School of Information Sciences, PITT

Dean Lowry Burgess, Professor, Fine Arts, Carnegie Mellon University

Dr. Stephen C. Hirtle, Professor, School of Information Sciences, PITT

Dr. Kurt VanLenh, Professor, Computer Science, PITT

Thesis Director/Dissertation Advisor: Dr. Michael Lewis, Professor,  
School of Information Sciences, PITT

**ANCIENT ARCHITECTURE IN VIRTUAL REALITY  
DOES IMMERSION REALLY AID LEARNING**

Jeffrey Jacobson, PhD  
University of Pittsburgh, 2008

Copyright © by Jeffrey Jacobson  
2008

This study explored whether students benefited from an immersive panoramic display while studying subject matter that is visually complex and information-rich. Specifically, middle-school students learned about ancient Egyptian art and society using an educational learning game, *Gates of Horus*, which is based on a simplified three dimensional computer model of an Egyptian temple. First, we demonstrated that the game is an effective learning tool by comparing written post-test results from students who played the game and students in a no-treatment control group. Next, we compared the learning results of two groups of students who used the same mechanical controls to navigate through the computer model of the temple and to interact with its features. One of the groups saw the temple on a standard computer desktop monitor while the other-saw it in a visually immersive display (a partial dome) The major difference in the test results between the two groups appeared when the students gave a verbal show-and-tell presentation about the Temple and the facts and concepts related to it. During that exercise, the students had no cognitive scaffolding other than the Virtual Egyptian Temple which was projected on a wall. The student navigated through the temple and described its major features. Students who had used the visually immersive display volunteered notably more than those who had used a computer monitor. The other major tests were questionnaires, which by their nature provide a great deal of scaffolding for the task of recalling the required information. For these tests we believe that this scaffolding aided students' recall to the point where it overwhelmed the differences produced by any difference in the display. We conclude that the immersive display provides better supports for the student's learning activities for this material. To our knowledge, this is the first formal study to show concrete evidence that visual immersion can improve learning for a non-science topic.



## TABLE OF CONTENTS

<b>PREFACE</b> .....	<b>XVI</b>
<b>1.0 INTRODUCTION</b> .....	<b>1</b>
<b>2.0 BACKGROUND</b> .....	<b>3</b>
<b>2.1 WHAT IS VIRTUAL REALITY?</b> .....	<b>4</b>
<b>2.1.1 Our Working Definition of VR</b> .....	<b>4</b>
<b>2.1.1.1 A Three-dimensional Space:</b> .....	<b>5</b>
<b>2.1.1.2 Autonomy: The virtual environment (VE) persists</b> .....	<b>5</b>
<b>2.1.1.3 Interaction The user interacts with the virtual environment</b> .....	<b>5</b>
<b>2.1.1.4 (Thematic) Presence The interface informs the senses</b> .....	<b>6</b>
<b>2.1.1.5 (Sensory) Presence This is the feeling of <i>being there</i></b> .....	<b>6</b>
<b>2.1.2 The VR Research Community’s Definition of VR</b> .....	<b>7</b>
<b>2.1.3 Educators’ Descriptions of VR</b> .....	<b>8</b>
<b>2.1.4 Augmented Reality</b> .....	<b>9</b>
<b>2.2 VR IS EXPRESSIVE</b> .....	<b>11</b>
<b>2.2.1 Dimensions of Information</b> .....	<b>12</b>
<b>2.2.2 Dimensions of Expression</b> .....	<b>13</b>
<b>2.2.3 One Dimensional Formats:</b> .....	<b>14</b>
<b>2.2.4 Two Dimensional Formats:</b> .....	<b>14</b>
<b>2.2.5 Three Dimensional Formats</b> .....	<b>15</b>
<b>2.2.6 Four Dimensional Formats</b> .....	<b>16</b>
<b>2.2.6.1 Five Dimensional Formats</b> .....	<b>16</b>
<b>2.3 VR TECHNOLOGY</b> .....	<b>17</b>
<b>2.3.1 Informative 3D Models</b> .....	<b>17</b>
<b>2.3.2 Advancing Graphics Technology</b> .....	<b>19</b>

2.3.3	Flight Simulators .....	21
2.3.4	Head-Mounted Displays.....	22
2.3.5	Flat-Screen Projection-Based Immersive Displays .....	23
2.3.6	Digital Dome Displays .....	25
2.3.7	Direct Retinal Imagers .....	26
2.3.8	Interaction Devices .....	26
2.3.9	Online Communities.....	29
2.3.10	Augmented Reality .....	31
2.4	<b>ADAPTIVE HYPERMEDIA.....</b>	<b>32</b>
2.4.1	User Modeling .....	33
2.4.2	Methods of Adaptation.....	34
2.4.3	Some Applications .....	36
2.4.4	Augmenting Virtual Space with Adaptive Behaviors .....	37
2.4.5	Augmenting Physical Space with Adaptive Behaviors.....	38
2.4.6	Learning Games.....	38
2.5	<b>LEARNING THEORY AND VR.....</b>	<b>41</b>
2.5.1	Constructivism.....	42
2.5.2	Direct Interaction with Information .....	45
2.5.3	Presence and Engagement .....	47
2.5.4	Information Delivery in VR.....	48
2.5.5	Mayer’s Multimedia Design Principles .....	49
2.5.6	Mayer's (Cognitive) Theory of Multimedia Learning.....	51
2.5.7	Distributed Cognition and Internal Representation .....	53
2.5.8	Conceptual Change.....	55
2.5.9	Learner Differences.....	57
2.5.10	Measurement and Evaluation .....	59
2.5.11	Winn’s Synthesis.....	60
2.6	<b>EMPIRICAL STUDIES OF LEARNING WITH IMMERSIVE VR.....</b>	<b>62</b>
2.6.1	Introduction .....	62
2.6.2	Advantages .....	64
2.6.3	Problems .....	65

2.6.4	Summary of Previous Experiments .....	66
2.6.5	Moreno’s Research .....	68
2.6.6	Research at the University of Washington .....	69
2.6.6.1	The Effect of Student Construction Of Virtual Environments.....	70
2.6.6.2	Learning Science in an Immersive Virtual Environment. ....	70
2.6.6.3	Constructivism in Practice: The Case for Meaning-Making.....	71
2.6.6.4	Collaboration and Learning Within Tele-Immersive.....	71
2.6.6.5	Water on Tap: The Use of Virtual Reality as an Educational.....	71
2.6.6.6	Design And Construction Of A Virtual Environment. ....	72
2.6.7	The Science Space Experiments .....	73
2.6.7.1	Using VR's Frames of Reference in Mastering. ....	73
2.6.7.2	Multisensory Immersion as a Modeling Environment .....	74
2.6.7.3	A Model for Understanding How Virtual Reality.....	74
2.6.8	The NICE Projects.....	74
2.6.9	The Virtual Gorilla Exhibit .....	75
2.7	VIRTUAL HERITAGE .....	76
2.7.1	History of VH.....	76
2.7.2	Advantages .....	78
2.7.3	Problems .....	80
2.7.4	Building a VH Environment.....	81
2.7.5	Lifelike Pedagogical Agents.....	85
2.7.6	Current Activity in Virtual Heritage .....	89
3.0	EXPERIMENT.....	92
3.1	INTRODUCTION .....	93
3.2	RATIONALE .....	96
3.3	GATES OF HORUS.....	98
3.3.1	Interface.....	99
3.3.2	Training Phase .....	104
3.3.3	Game Logic .....	106
3.3.3.1	Definitions.....	107
3.3.3.2	Actions .....	108

3.3.4	Statements and Questions .....	109
3.3.4.1	Pylon.....	110
3.3.4.2	Courtyard .....	112
3.3.4.3	Hypostyle Hall. ....	114
3.3.4.4	Sanctuary .....	116
3.4	HYPOTHESES .....	119
3.5	TEST POPULATION AND PILOT STUDY .....	121
3.6	TESTING SEQUENCE.....	122
3.7	DATA GATHERING .....	125
3.7.1	Online Evaluation Forms.....	125
3.7.2	Multiple Evaluators.....	128
3.7.3	Access to the Forms .....	130
3.7.4	Data Management.....	131
3.8	THREATS TO VALIDITY .....	133
3.8.1	Immersive VR is Engaging Because It Is New.....	133
3.8.2	Motion Sickness .....	133
3.8.3	Application & Interaction Design .....	134
3.8.4	Limited Quantity of Content .....	134
3.8.5	Fixed Learning Time.....	135
3.8.6	Fatigue .....	135
4.0	POST TEST RESULTS (ACCEPTANCE AND EFFECTIVENESS).....	136
4.1	ACCEPTANCE.....	137
4.2	QUESTIONS IN THE POST TEST .....	139
4.3	GRADING THE OPEN-ENDED QUESTIONS.....	142
4.4	INTERRATER RELIABILITY ANALYSIS.....	144
4.5	HYPOTHESIS TESTS.....	148
4.6	COMPARE WITH RPM RESULTS .....	152
5.0	VIDEO TEST RESULTS (IMMERSION HELPS).....	154
5.1	DESCRIPTION.....	155
5.2	GRADING .....	158
5.3	INTERRATER RELIABILITY ANALYSIS.....	163

5.3.1	Our Data is Ordinal and Not Normally Distributed .....	166
5.3.2	Calculating Interrater Reliability .....	167
5.3.3	Grader Agreement.....	168
5.4	RESULTS, FACTUAL KNOWLEDGE.....	172
5.5	RESULTS, CONCEPTUAL KNOWLEDGE .....	179
5.6	RPM INTERACTS WITH IMMERSION .....	188
5.7	DISCUSSION.....	196
6.0	OTHER MEASURES .....	197
6.1	PRETEST .....	198
6.2	GAME LOGS.....	200
6.3	PRESENCE AND COMFORT TEST .....	204
6.4	DRAWN MAP.....	208
6.5	MAGNET MAP .....	215
6.6	FOLLOW-UP TEST .....	221
6.6.1	Description .....	221
6.6.2	Grading.....	226
6.6.3	Results.....	228
6.6.4	Other Questions .....	234
7.0	SUMMARY AND CONCLUSION.....	236
7.1	BACKGROUND .....	238
7.1.1	What is Virtual Reality? .....	238
7.1.2	VR Is Expressive.....	240
7.1.3	VR Can Accommodate the Learner.....	240
7.1.4	Sensory Presence Is Not Enough.....	242
7.1.5	Immersion Must Support the Learning Activity .....	243
7.1.6	Virtual Heritage.....	244
7.1.7	Learning Games.....	244
7.2	EXPERIMENT .....	246
7.2.1	Rationale.....	246
7.2.2	Gates of Horus .....	247
7.2.3	Hypotheses.....	249

7.2.4	Protocol.....	250
7.3	<b>RESULTS .....</b>	<b>251</b>
7.3.1	Acceptance.....	251
7.3.2	Effectiveness .....	252
7.3.3	Immersion.....	253
7.3.4	Other Measures.....	254
7.3.5	Visual Reasoning Skill.....	254
7.4	<b>DISCUSSION.....</b>	<b>256</b>
<b>APPENDIX A; ONLINE QUESTIONNAIRES.....</b>		<b>259</b>
	<b>PRETEST .....</b>	<b>260</b>
	<b>PRESENCE AND COMFORT TEST .....</b>	<b>263</b>
	<b>DRAWN MAP GRADING FORM.....</b>	<b>264</b>
	<b>MAGNET MAP GRADING FORM .....</b>	<b>268</b>
	<b>VIDEOTEST GRADING FORM .....</b>	<b>272</b>
	<b>POST TEST .....</b>	<b>287</b>
	<b>POST TEST GRADING FORM.....</b>	<b>292</b>
	<b>FOLLOW-UP TEST .....</b>	<b>297</b>
	<b>FOLLOW-UP TEST GRADING FORM.....</b>	<b>303</b>
<b>APPENDIX B; TESTING PACKET .....</b>		<b>307</b>
<b>APPENDIX C; EGYPT BOOKLET .....</b>		<b>321</b>
<b>APPENDIX D; OTHER MATERIALS .....</b>		<b>345</b>
	<b>PERMISSION FORM.....</b>	<b>346</b>
	<b>EGYPT FOLLOW-UP LETTER .....</b>	<b>351</b>
	<b>GIFT CERTIFICATE LETTER .....</b>	<b>352</b>
	<b>GIVING VIDEO LETTER.....</b>	<b>353</b>
	<b>RECRUITING FLIER.....</b>	<b>354</b>
	<b>HINT CARDS .....</b>	<b>355</b>
<b>BIBLIOGRAPHY .....</b>		<b>357</b>

## LIST OF TABLES

Table 1. Previous Experiments with Immersive VR .....	67
Table 2. Virtual Heritage Projects .....	89
Table 3: Affective Questions and Raw Results .....	137
Table 4. Affective Questions .....	138
Table 5. Questions from the Post Test .....	140
Table 6: Grader's form for scoring open-ended questions .....	143
Table 7. Short-Answer Questions Interrater Reliability for the Post Test .....	145
Table 8. Comparison of Learning from the Post Test Short Answer Questions.....	149
Table 9. Hypothesis Results from the Post Test .....	151
Table 10. Post Test H1 Comparison Crossed with RPM Results. ....	153
Table 11. Video Grading Form Questions .....	159
Table 12. Sample Data for One Fact.....	164
Table 13. Interrater Reliability Analysis of the Video Data .....	169
Table 14. Sample Data Converted To Numbers .....	172
Table 15. Sample Portion of Hypothesis Test Tables.....	174
Table 16: Factual Recall, Theater Group versus All Others .....	176
Table 17. Conceptual Understanding, Theater Group versus All Others .....	182

Table 18. Connections Between Factual Recall and Conceptual Understanding .....	184
Table 19. Results from RPM Test, Question sets C & D. ....	189
Table 20: RPM Scores Crossed With Factual Learning Differences .....	191
Table 21: RPM Scores Crossed With Conceptual Learning.....	194
Table 22: Pretest Results.....	199
Table 23. Results from the Game Logs .....	201
Table 24: Results from the Presence and Comfort Test .....	206
Table 25: Drawn Map Grading Form Questions. ....	210
Table 26: Results for Student Drawn Maps.....	213
Table 27: Magnet Map Grading Form Questions. ....	217
Table 28: Results of the Magnet Map Test.....	219
Table 29: Follow-Up Test Questions.....	222
Table 30: Follow-Up Grading Form.....	226
Table 31: Interrater Reliability for Short-Answer Question on the Follow-Up Test.....	229
Table 32: Follow-Up Test Grader Reports Hypothesis Test .....	232
Table 33: Multiple Choice Questions Hypothesis Test .....	233
Table 34: Results of Affective Measures in the Follow-Up Test .....	235
Table 35. Summary of RPM Effect .....	255



## LIST OF FIGURES

Figure 1. The Virtual Egyptian Temple in the Earth Theater .....	1
Figure 2. Schematic of the Great Pyramyd (Kufu, 2004) .....	17
Figure 3. An Ancient Roman Kitchen (Capasso 2004). .....	18
Figure 4. Advent's Children (RopeOfSilicon 2004) .....	20
Figure 5. UT2007 (EpicGames 2007).....	20
Figure 6. Exterior (left) and interior (right) of a flight simulator (Simlabs 2006).....	21
Figure 7. Two HMDs (left) from Cybermind (2006) and (right) from Virtual Realities (2006)..	22
Figure 8. User in the SAS-Cube, exploring a virtual nightclub (ALTERNE 2005).....	23
Figure 9. The Virtual Theater (Jacobson 2005c) .....	24
Figure 10. Dome display at Digital Life (2006) courtesy of the Elumenati (2008).....	25
Figure 11. IS-900 MiniTrax Wand Tracker (Intersense 2006) .....	27
Figure 12. CyberGlove (Metamotion 2006). .....	28
Figure 13. An avatar in Second Life conversing with the user.....	29
Figure 14. Player avatars in World of Warcraft, a popular MMORPG .....	30
Figure 15. Mayer's Learning Model .....	52
Figure 16. The Cyclorama at Gettysburg, USA.....	77
Figure 17. Example of shape vs. texture to produce detail (Papiaoannou 2003).....	82

Figure 18. The Sanctuary of the Virtual Egyptian Temple displaying in the Earth Theater. ....	93
Figure 19. Temple of Horus and the high priest .....	98
Figure 20. The Gyromouse .....	100
Figure 21. Hawk statue and object selection cursor. ....	101
Figure 22. “Moving” through the Virtual Egyptian Temple in the Earth Theater.....	102
Figure 23. Overhead Diagram of the Earth Theater Main Screen .....	103
Figure 24. Side View Diagram of the Earth Theater .....	103
Figure 25. Training Area.....	105
Figure 26. The Pylon.....	110
Figure 27. The Courtyard.....	112
Figure 28. Hypostyle Hall.....	114
Figure 29: The Sanctuary.....	116
Figure 30. Gates of Horus Trigger Volumes in the Temple .....	118
Figure 31. Sample page from the online Post Test.....	126
Figure 32. Sample page from the online Grading Form for the Post Test.....	127
Figure 33. Sample Index of Online Grading Forms .....	130
Figure 34. The Grading Matrix.....	131
Figure 35. Key Affective Results.....	138
Figure 36. Video Test Setup .....	155
Figure 37. Student (shown in silhouette) giving a tour of the temple.....	156
Figure 38. Sample Page From the Video Grading Form .....	158
Figure 39. Conceptual Grading Form. ....	180
Figure 40. Sample Question from the RPM Test.....	189

Figure 41. Presence and Comfort Test.....	205
Figure 42. Sample Drawn Temple Map (left) and a sample Drawn Room Map (right).....	209
Figure 43. Blank Map of the Temple.....	215
Figure 44. Magnetic Cutouts.....	216
Figure 45. Did paying the game, Gates of Horus make you any more interested in learning about Egypt?.....	234
Figure 46. Virtual Egyptian Temple and the High Priest .....	236
Figure 47. Map of the Virtual Egyptian Temple.....	247
Figure 48. The Temple in the Earth Theater.....	248
Figure 49. Key Affective Results.....	251
Figure 50. Post Test Sequence and Results. ....	252
Figure 51. Video Test Sequence and Results.....	253

## PREFACE

I dedicate this dissertation to the late Dr. William Winn of the Department of Education at the University of Washington. During his time on my PhD committee, Dr. Winn's guidance was central to my experimental design and background research. A wise scholar and a gentle man, his work in the area of Virtual Reality for children's education was an inspiration to me and to many others.

I express further thanks and deep appreciation to these individuals (in alphabetical order):

- Dr. Michael Lewis, my advisor, who worked especially closely with me over the years, showing great wisdom and patience.
- Kerry Handron, my co-investigator for the actual learning experiments. She participated in every level of the implementation, recruited all of the test subjects and managed resources at the Earth Theater in the Carnegie Museum of Natural History of Pittsburgh, where we conducted the experiments.
- Dean Lowry Burgess, who worked especially closely with me over the years on matters of content and dramaturgy. His insights on how to engage human nature were crucial to the design and success of this study.
- Lynn Holden, Egyptologist and co-Author of the *Gates of Horus* learning game. My thanks to him for providing the educational content for my learning experiment and for valuable insights.
- Dr. Anne Faye, in the Office of Technology in Education at Carnegie Mellon University for her important early help with navigating the educational research questions.
- Dr. Roy D. Harris for being a friend, mentor and advisor through the whole process.
- Dr. Mack C. Shelley for crucially important help in selecting the appropriate statistical methods I used to analyze the results.

- Gordon Orris and Jane Vadnal for their excellent (and merciless) editing. To Jane, again for other help in production of materials for the experiments.
- To Kathy Bruckner, Adrienne Baker, Benjamin Getkin, Jane Vadnal and Lynn Holden for their excellent work in evaluating the students' performance in the posttests.
- To Mary Smith for helping us recruit so many test subjects, and for her early advice on how to structure the post-treatment quizzes.
  
- Richard Graefe, Gordon Orris, and Jane Vadnal for their excellent (and merciless) editing. To Jane, again for other help in production of materials for the experiments.
- To Kathy Bruckner, Adrienne Baker, Benjamin Getkin, Jane Vadnal and Lynn Holden for their excellent work in evaluating the students' performance in the post-tests.
- To Mary Smith for helping us recruit so many test subjects and for her early advice on how to structure the post-tests.

The following institutions also deserve appreciation and acknowledgement.

- The School of Information Sciences at the University of Pittsburgh for providing a supportive and resourceful environment for me to do this work.
- The Carnegie Museum of Natural History of Pittsburgh for supporting this research by making the Earth Theater and its resources available for the study.
- PublicVR for creating and distributing the open-source software (CaveUT, VRGL and Gates of Horus) we relied upon to conduct the study.
- EpicGames for their general support for academic research using the game Unreal Tournament 2004 and its software core, the Unreal Engine.

Last, but far from least, I thank my very patient husband Christopher Graefe, for putting up with me during the whole crazed process.

**The best way to read this document is to start with “Summary and Conclusion” (section 7.0 p236).**

## 1.0 INTRODUCTION

This study explored whether students benefit from an immersive panoramic display while studying subject matter which is visually complex and information-rich. Specifically, middle-school students learned about ancient Egyptian art and society using an educational learning game, *Gates of Horus* (section 3.3, p247), which is based on a simplified virtual model of an Egyptian temple. First, we demonstrated that the game is an effective learning tool by comparing written post-test results from students who played the game from and student in a no-treatment control group.



**Figure 1.** The Virtual Egyptian Temple in the Earth Theater

Next, we compared the learning results of two groups of students who used the same controls to navigate through the temple and interact with its features. One group saw the temple on a standard desktop computer monitor while the other saw it in a visually immersive display (a partial dome). The difference appeared when each student gave a verbal show-and-tell presentation of the temple and the concepts and facts related to it. During the student's presentation, she had no cognitive scaffolding other than the virtual temple, on a small wall

projection, which the student navigated during the presentation. The other major tests were questionnaires, which by their nature provide a great deal of scaffolding for the task of recalling the required information. For these tests we believe that this scaffolding aided students' recall to the point where it overwhelmed the differences produced by any difference in the display.

We conclude that the immersive display provides better supports for the student's learning activities for this material. To our knowledge, this is the first formal study to show concrete evidence that visual immersion can improve learning for a non-science topic.

**The best introduction to this study is to first read “Summary and Conclusion” (section 7.0 p236).**

## 2.0 BACKGROUND

In this chapter, we will introduce the existing theory and practice upon which we based our study. It begins with an exploration of the concepts and practices which comprise Virtual Reality and our own working definition of the term. Next, we survey existing VR technology. Then we discuss how applications can be made responsive to individual users and their changing needs in the Adaptive Hypermedia section. Games are special case of adaptive media. After that, we will go into some detail to explain the important educational theories which inform the productive use of virtual reality and learning applications. This provides the context for the next section, in which we address directly the advantages and disadvantages of using Immersive Virtual Reality for education. There, we survey and discuss previous studies and the implications of their findings. Finally, we will survey the field called Virtual Heritage, the applications and practice of using VR to recreate historical artifacts as they are or as they might have been. Our learning game, Gates of Horus, is an adaptive application which employs a pedagogical agent. The temple served as the centerpiece of our learning experiments with Immersive VR. This major section will give us the context we need to situate and implement our study.



## 2.1 WHAT IS VIRTUAL REALITY?

Virtual Reality has existed in various forms for some time, but the term did not gain wide use until it was popularized by William Gibson (1984). There is still no final agreement on its precise meaning, in part because VR is being developed and employed by several distinct research communities, each with different goals, methods, theories and vocabularies. As VR technology continues to advance and its cost continues to decline, more communities are developing VR-based applications. This study will focus on two of these groups, educators and the traditional VR-research community. This section will describe, (1) the features of VR, which are generally agreed upon, (2) what VR means to the traditional VR-research community, and (3) what VR means to the educational research community. Later sections of this survey will refer to VR as the educators do and will reference the taxonomy and the core principles of VR described here. The term *Immersive VR* will be used unambiguously to refer to VR applications which produce sensory immersion.

### 2.1.1 Our Working Definition of VR

This section discusses the key aspects of virtual reality which are shared among most users and researchers, despite cross-disciplinary differences in terminology and approach.

A “Virtual Environment” (VE) is an artificial space, an imaginary or illusory world, created and maintained by appropriate computer applications. The user interacts with the VE and may also interact with objects, agents or representations of other users found in the VE. For example, a flight simulator presents an illusory landscape over which the user appears to fly over. The act of navigating the imaginary aircraft through the VE is a way of interacting with it. The VE may have other virtual aircraft within it, piloted by other users or by software agents. Another example of a Virtual Environment is the online shared VR applications which support virtual environments accessible via the Internet. Each user is represented by an avatar, a

representation (usually humanoid), with which they interact with the VE and with the other users there (SecondLife, 2004; There, 2004; Dede, 2004).

The term, Virtual Reality, (VR) generally refers to using a computer to interact with a virtual environment. The Encyclopedia Britannica (2004) says VR is, “The use of computer modeling and simulation to enable a person to interact with an artificial three-dimensional visual or other sensory environment.” More specific definitions of VR all depend upon David Zeltzer's often cited definition, which maintains that a VR application must have or provide “autonomy, interaction and presence” (Zeltzer, 1992). However, the meaning of the term “Virtual Reality” continues to evolve and differentiate, as disparate research communities find new ways to use it. We present our own working definition for VR, which we state as criteria:

**2.1.1.1 A Three-dimensional Space:** The user perceives an illusory three-dimensional “space” known as the *Virtual Environment* (VE). The VE is an illusion is composed of information rendered into a form the user can perceive. Usually, the representation is visual, although many VR applications use sound, touch, proprioception, and other senses

**2.1.1.2 Autonomy:** The virtual environment (VE) persists and changes with or without a user present. Part of this illusion of temporal coherence is caused by the way in which virtual objects and actors respond to the user; they develop in a manner consistent with their purpose and with the overall theme of the environment. For example, the NICE project (Roussos 1999) is based on a shared children's “virtual garden” where, for example, the carrots continue to grow whether any children are “present” or not. Each time a child “visits” the garden through some VR interface, s/he will “see” the carrots in some state resulting from when the carrots were originally “planted,” the (virtual) growing conditions and what the other children may have been doing in the garden.

**2.1.1.3 Interaction** The user interacts with the virtual environment in a meaningful way (Zeltzer, 1992). In many VR applications, the central interaction is the ability of the user to navigate through the VE, thus appearing to travel in the virtual space. A higher degree of interaction gives the user some means of influencing the elements in the VE, whether it is simply moving objects or interacting with an intelligent computer-generated agent or with another user “in” the VE.

Central to interaction is the relationship between objects in the VE and the user's viewpoint. In a *first person view*, the user is embodied in the viewpoint, as it moves through the environment. In a *third-person view*, the user is represented or embodied by an avatar, usually a humanoid figure. The user navigates by moving the avatar while the viewpoint tracks it some algorithm (Sheridan 1992). In a “world-in-miniature view, everything in the VE appears within the user's view, and the user manipulates the VE, usually by rotating it, while the viewpoint (apparently) remains stationary. Many variations on these themes exist, as well as entirely different navigation schema.

**2.1.1.4 (Thematic) Presence** The interface informs the senses so that the user “feels” as if s/he is in a particular location within the virtual environment (Zeltzer 1992). Perspective correction and other aspects of a visual display define the user's *egocenter*, which is the user's location in the virtual environment (Psotka 1996). The display must produce at least a very wide view for the user, such as those provided by a digital partial-dome theater (e.g. a Planetarium) or a *Head Mounted Display* (HMD). See section 2.3, p17, for examples.

**2.1.1.5 (Sensory) Presence** This is the feeling of *being there* in the virtual world (VE), the sense that the VE is your environment, rather than the real world or perhaps in addition to it. When Zeltzer (1992) first published his three requirements, he emphasized the sense of presence that comes from sensory immersion. Sensory immersion depends on physically creating the illusion of a virtual space with a combination of sensory effects, most commonly based on imagery. The use of sound is also common, and there are established technologies for adding physical motion cues, haptic feedback and even olfactory input (Stanney, 2002). Presence is typically measured with introspective questions for the user (Witmer, 1998b; Lessiter, 2001; Slater, 1999; Pausch, 1997; Darken, 1999b).

In the following discussion, we will call applications satisfying all five criteria, *Immersive Virtual Reality* (Immersive VR) and those which satisfy only the first four criteria, *Desktop Virtual Reality* (Desktop VR). We retain *Virtual Reality* (VR) as a general term referring to both.

### **2.1.2 The VR Research Community's Definition of VR**

Members of the mainstream VR research community usually adheres closely to Zeltzer's (1992) definition of VR, "autonomy, interaction, and (sensory) presence" described above. They implicitly add that any respectable VR display must be capable of stereographic imaging.

Most researchers in this community are concerned with VR technology and its applications. Most are computer scientists and many of the rest are electrical engineers, interaction designers or experts in ergonomics. There are also a few researchers from disciplines representing current or intended user communities for VR applications. It is very common for members of this community to combine expertise from several of these fields. Researchers in this group receive much of their funding directly or indirectly from the American military; their most common use of VR remains training and simulation for pilots, navigators and soldiers. Other funding comes from medical applications, education, geology, entertainment, archeology, geographic information systems and human-computer interaction. In Europe, there is significant funding for applications in cultural heritage and historical preservation (section 2.7, p76).

The core of the traditional VR research community is primarily concerned with the physical interfaces for VR and their psychological and ergonomic effects. This leads them to stress the immersive aspects of VR and the fidelity and cohesiveness of the VE. A good example is Kay Stanney's Handbook of Virtual Environments (2002). In her book bulk of the introductory chapter and most of the other chapters are devoted to topics directly related to building functional Immersive VR interfaces and using them properly. Applications are also explored, but not in the same depth.

For the foreseeable future, the research agenda of this community will remain important, useful and in many ways central. However, they appear to have lost control of the meaning of the term "VR", because they are greatly outnumbered by user communities who employ a broader definition of VR.

### 2.1.3 Educators' Descriptions of VR

Educators and other user communities regard VR as any application which maintains a persistent virtual environment (autonomy) and within which users interact with each other, or objects, or independent agents. These communities place much less emphasis on the nature of the interface. For example, text-only MUD systems are regarded as a form of VR, as well as many desktop VR applications.

Because a wider range of applications are included, the educators' definition of VR requires modifying Zeltzer's (1992) definition of presence. Rather than pure sensory immersion, the engagement of attention is emphasized in a way that centers on a single reference point in the virtual environment, the user's *egocenter* (Psozka, 1996). All of the user's spatial interactions with and within the VE are relative to the user's egocenter.

Presence then becomes a special case of engagement, which describes the degree to which the user devotes his or her attentional resources to some activity within a VR environment. Many argue that the more engaged s/he is with some task "in" the VE, the greater the degree of presence—certainly, introspective questions of presence will yield higher scores in this case. Conversely, it may be that an increased sense of presence, perhaps from sensory immersion, will enhance the user's sense of engagement in the task(s) central to a particular VR application. To avoid a circular definition, let us say that presence is a particular type of engagement. Our definition of presence then becomes *psychological* presence which requires that the VR application has a defined egocenter for the user and that it successfully engages the user's attention.

Under educators' broader definition of VR, most educational applications fall into one of three groups:

- **Text-Only** The MUD (Multi-User Dungeon) support text-only interaction with the virtual environment and between the users. MUDs have existed for nearly twenty years, before the term VR was coined, but researchers who use MUDs now regularly refer to them as virtual worlds and to the MUDs as a form of virtual reality. Few are solitary, most support very large communities of users (Bruckman, 2002a).

- **Desktop** With Desktop VR, the user interacts with a persistent autonomous virtual environment using a standard computer monitor, keyboard and mouse. Applications can be solitary or support a large community of users (SecondLife, 2004; There, 2004; Dede, 2004; Cobb, 2002; Raiha, 1997). See section 2.3.9, p29, for more detail.
- **Immersive** These applications attempt to enlarge a VR environment beyond the scale of a computer monitor to more fully engage the users' senses, especially by improving the visual interface. Immersive VR applications usually use a Head Mounted Display (HMD) or a CAVE-like display in which several screens are used to simulate 3 dimensions. (Winn, 2003b; Jackson, 2000). Some of them also attempt to engage such other human capacities as hearing and the viewer's tactile sense.

This expanded definition appears to be stable and does not hinder educators who wish to experiment with Immersive VR. However, it raises questions about how the traditional VR research community, for whom the only VR is Immersive, references these other applications. They often rely heavily on the term "Virtual Environment." An example is the title of Kay Stanney's book, *Handbook of Virtual Environments* (Stanney, 2002). The book itself gives the best overview of VR research up to that time. To achieve its breadth, the book includes articles about important non-immersive VR applications. Accordingly, the title of the book uses "Virtual Environments" not "Virtual Reality," which covers these non-immersive applications. Stanney stretches the term "Virtual Environment," because many of the articles are about interfaces, not environments. We see no harm in this extension of the definition of VE, especially if the authors define the term within their context.

#### 2.1.4 Augmented Reality

Also worthy of mention is VR's close cousin, Augmented Reality (AR), which is the practice of using VR techniques to enhance a physical space (Papagiannakis, 2004a, 2004b; Ruiz, 2002; Sinclair, 2001; Addison, 2002). For example, AR Quake (Piekarski, 2002), users observe the real world through special glasses. Animated autonomous agents are added to the user's view by having the computer "paint" the appropriate imagery onto the surface of the glasses. The agents interact with each other, the terrain and with the user. With "Hippie" and related applications

(Oppermann, 1999; Baber, 2001), the user hears a topical narrative when s/he nears a point of interest in a museum. The narratives change adaptively, depending on who the user is and what s/he has seen previously. It could be said that there is a continuum of possible applications between pure reality and a true virtual environment, with the term *Augmented Reality* including everything in between.

## 2.2 VR IS EXPRESSIVE

Virtual Reality provides the educator with new ways to represent many objects and systems more effectively than with other media. For example, the VR user can interact with simulations of objects that cannot be perceived in the real world (Roussos, 1999) because they are too small, too big, dangerous, far away, no longer exist, do not exist yet, or are simply inconvenient. Students can make mistakes in a virtual environment safely and cheaply, which allows for learning activities not possible in the real world. A virtual environment can also simulate dynamic systems such as ocean currents, planetary motions, changes in electrostatic fields, or social behavior in a troop of gorillas. These simulations become especially powerful teaching tools when the student can participate in them, giving the student an inside view (egocentric) and the ability to experiment with the system (Winn, 1999; Bowman, 1999; Dede, 1999)

VR theorists often use the concept of dimensions or dimensionality to describe or define virtual environments and user interaction with them (Benedikt 1991, Wexelblat 1991, Bowman 2002). The most helpful dimensional taxonomies depend on the context for their intended use. Accordingly, the following taxonomy supports later discussion (in this study) of how different VR applications represent information and receive and respond to user input. The purpose of this section is to help the reader understand and classify educational applications based on VR by providing paradigms to describe:

1. The available dimensions in a VR interface: width, height, depth, time, sound, touch, proprioception, and taste/smell.
2. Dimensions to classify information: one-dimensional, two-dimensional, three-dimensional, multi-dimensional, temporal, tree and network. This is adapted from Schneiderman's (1996) Task by Type Taxonomy.
3. Ways to map the information to the display, with examples of common usage.

This taxonomy emphasizes how the user receives information from the display. For a detailed taxonomy on interaction, see Bowman (2002).



### 2.2.1 Dimensions of Information

In Schneiderman's (1996) *Task by Type Taxonomy*, he lists a series of “data types,” each ostensibly representing a type of information. Each data type is described along with its most appropriate vehicle. For example, two-dimensional information includes maps and images. The following is a somewhat modified list of Schneiderman's data types.

- **One Dimensional:** Text, including font, color, and meta-information like author or date. Anything that comes in a linear order, such as a list of names or clothes on a rack organized by size. At this level of abstraction, sound can be considered one dimensional. In reality, sound contains many dimensions within it, just as color does, but this overview will not address that level of detail.
- **Two Dimensional:** Planar or map data include geographic maps, floor plans, images, or newspaper layouts.
- **Three-dimensional:** Molecules, architecture, the human body, machine inner workings, etc.
- **Temporal:** Timelines, project schedules, fictional or historical narratives, etc. Users often query the temporal ordering and grouping of things.
- **Multi-Dimensional:** N-dimensional data, usually stored in a relational database.
- **Tree:** Hierarchical information.
- **Network:** There are many types of networks, primarily acyclic, lattice, rooted, unrooted, and entity-relationship diagrams. Visualizing this type of information is useful for determining relationships, identifying cycles and finding short paths between points in the network.

## 2.2.2 Dimensions of Expression

These dimensions refer to the way in which the user experiences the virtual environment, which is why the first four and the remaining items can appear on the same list. The level of granularity in this list is arbitrary, formulated to suit the level of this discussion. For a much more detailed taxonomy of the senses, see Spring (1992).

1. **Width:** Horizontal length with respect to the user's view.
2. **Height:** Vertical length.
3. **Depth:** Distance away from the user's viewpoint.
4. **Color:** The color(s) of objects within the environment.
5. **Time:** The temporal aspect of a user's interaction with some person, place or thing in the virtual environment.
6. **Sound:** This can range from monophonic sound from a computer speaker to fully spatialized sound.
7. **Touch:** Also known as “haptic feedback,” or “force feedback.” The simulated ability to touch a virtual object. The user manipulates some physical device, such as a special glove or stylus, which creates the sensation of touch when the device's analog in the virtual environment encounters an object.
8. **Proprioception:** The sense of orientation or movement sensed through the vestibular system, visual system and sense of touch.
9. **Taste:** We are not aware of any VR displays which employ this sense.
10. **Smell:** Some VR displays to release odors as directed by the VR software.

In this section, we will present ways in which information can be mapped to aspects of the computer display. We categorize these aspects by the number and type of dimensions by which they can convey or represent information. The most important dimensions readily visible in any

each sensory mode are called “dominant,” an arbitrary distinction based on how the user is expected to experience or think about the display. The discussion is also weighed towards display rather than interaction. For a detailed taxonomy interaction, we recommend Bowman (2002). While the discussion is intended for VR displays, others are included for context.

### **2.2.3 One Dimensional Formats:**

There is no immersive, one dimensional display but static text is the nearest approximation; narrative fiction, for example. Static text requires that either height or width be dominant (height for Asian languages and width for most others) and but allows some contribution from other dimensions—just enough to allow the letters and characters to be readable. Color, font, point-size, and so on, are all subordinate to height or width in this case. In reality, the typical page of text is a two dimensional presentation and its layout can have an important influence on the viewer. Nevertheless, the user's attention primarily moves along one dimension, from one word to the next.

### **2.2.4 Two Dimensional Formats:**

Most applications of the familiar print and electronic media are two-dimensional.

1. One of the most common applications of the two dimensional display includes maps, images, static web pages, maps, floor plans, newspaper layouts, etc. This would include many forms of Schneiderman's “Temporal” data—a graphed schedule (PERT chart, GANT chart, etc.) for example. The dominant dimensions are height and width.
2. Sound-only presentations belong to this category as well, because they have two dominant dimensions, time and sound.
3. A popular two dimensional display is the text-only “chat” interface, which allows the user to interact in real time with other users by reading and typing text. Here, the two dominant dimensions are width and time. If Asian characters are used in a vertical display, those would be height and time.

4. All MUDs use a text-based “chat” interface and maintain persistent virtual environments and social interactions. The virtual environment and the actions of the actors within it are “displayed” as textual description. However, some scholars maintain that a MUD maps many dimensions into the one dimensional text-most often arguing that MUDs exist in width and time.
5. Static three-dimensional images can be projected onto the two dimensional surface, as with a photograph, painting or drawing. In these cases, depth has to be included as a subordinate dimension, indicated by perspective, occlusion and shading effects. There is actually a spectrum of displays between two and three dimensions, so a good photograph may well be considered a *2.5 dimensional* display. Though height and width are dominant with these representations, depth can be suggested and color can be indicated, though rarely faithfully reproduced.

### **2.2.5 Three Dimensional Formats**

1. Static images of molecules, architecture, the human body, machine inner workings, etc., when shown with a volumetric display. Most volumetric displays use stereopsis to display depth information.
2. A three-dimensional display can be mimicked in a dynamic two-dimensional display, such as a computer monitor by introducing factors such as user viewpoint motion, the motion of objects in the environment or both. Fred Brooks (2004) states that the recovery of form from motion is stronger than stereopsis. A way to get depth-from-motion is to add head-tracked perspective correction, so the viewer's own motion contributes. These displays provide indications of height, width and depth.
3. Interactive silent applications which employ a two-dimensional interface but show change over time. Examples include a large variety of games (i.e. Pac Man) and some virtual communities (i.e. Randy Farmer's “Habitat,”) These applications employ height, width, and time.

4. A silent movie. Height, width, and time are predominant, though depth can be implied as a minor dimension.

### **2.2.6 Four Dimensional Formats**

1. Interactive multimedia applications where the dominant dimensions are height, width, time and sound.
2. Silent, interactive VR applications using a three-dimensional display. Height, width, depth and time.

#### **2.2.6.1 Five Dimensional Formats**

1. Interactive VR with spatialized sound, or a typical movie. Height, width, depth, time and sound.

From the forgoing examples, it is clear that the basic idea of mapping the dimensions of the data to dimensions of the display is fairly straightforward. However, the science of it (data visualization) and the art of it (information design) is very complex and beyond the scope of this study. This is especially true for data which has a many dimensions or which cannot be defined in terms of dimensions (i.e. tree or network), but can only be displayed using a limited number of dimensions.

## 2.3 VR TECHNOLOGY

Recent trends in the technologies which can be used for VR applications have opened up many new possibilities. The following sections provide an overview of these possibilities.

### 2.3.1 Informative 3D Models

Scientists, engineers, archaeologists, and many other professionals increasingly use three-dimensional models to represent information and interact with it. While the majority of applications which employ 3D models do not qualify as DesktopVR, many do (section 2.1, p4). They range from simple and elegant, to rich in complexity and information. A model may be created by human artists as an original work or as a virtualization of something that already exists in the physical world. Some 3-D models could also be a visualization of some stream of data, such as the fluid dynamics of a cloud front, an abstract representation of the stock market, or the result of a CAT scan. Figure 2, below, is a good example of a useful model.

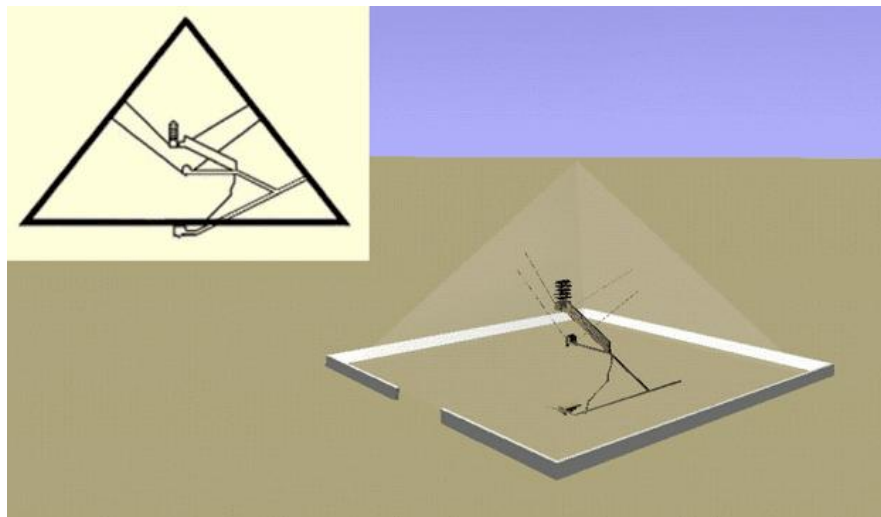

**Figure 2.** Schematic of the Great Pyramid (Kufu, 2004)

Most of the simple 3D models are written in the old VRML programming language, it's probable successor X3D (Web3D, 2006) or one of many lesser-known alternatives. Models of

this type are easy to produce and can be made part of a web-based application. For example, an object in a VRML-based virtual world can have a standard hyperlink associated with it, so that clicking on the object in a virtual world might display a web page in another frame on the same page (Jacobson, 1998h). More complex models are usually built with advanced commercial tools such as Maya or 3D-Studio Maxx (Autodesk, 2006).



**Figure 3.** An Ancient Roman Kitchen (Capasso 2004).

VRML and X3D support simple animations which can be compelling in the hands of an imaginative designer. On the other hand, tools such as Maxx and Maya support very complex animations which can provide greater levels of detail and subtlety. The most sophisticated examples include computer-animated movies such as Final Fantasy (FinalFantasy, 2001) and interactive video games, such as Doom (Id\_Software, 2004) or Unreal Tournament (EpicGames, 2007).

Finally, authoring tools are available for content-creation in the more advanced video games, and they take input from the professional authoring tools. Some of them, like Unreal Tournament 2004, are partially open-source, allowing for extensive reprogramming of existing

games and creation of new content by members of the public (EpicGames, 2004; Id\_Software, 2004).

### **2.3.2 Advancing Graphics Technology**

Detailed three-dimensional computer graphics require a great deal of computing power, especially if they are dynamic or interactive. Typically, the application must produce thirty visual frames per second to produce convincing movement through the virtual space. As recently as the late 1990s, high quality computer graphics required computers which were powerful, specialized, and very expensive.

Today, advanced graphics hardware is available to the mass market through new video cards (nVidia 2007; ATI 2007; Lewis 2002) for standard home computers and special-purpose game computers, called playstations (i.e., Xbox, PS2 and others). Because of this, the game industry has grown larger than the movie industry by every measure and shows no sign of slowing down its drive towards ever-faster home-computer graphics. Nearly everyone involved in computer graphics has taken advantage of the game industry spinoff technologies.

The efficiency of a highly optimized game engine can be ten to one hundred times greater than general-purpose graphics software. However, high-performance graphics engines (game engines) are always highly optimized and often quite specialized. For any particular game engine, some features are trivially easy to employ in a VR application, while other features can be harnessed by with specialized knowledge and good programming support. Still others are simply unavailable. The key for VR application development using these graphics engines is careful advance study to choose the right one and a willingness to expend the effort to learn the chosen engine well. Figure 4, below, shows a movie rendered using the latest graphic technology. Figure 5, below, shows a scene from one of the most advanced computer games.





**Figure 4.** Advent's Children (RopeOfSilicon 2004)



**Figure 5.** UT2007 (EpicGames 2007)

Because of the technical challenges, many authors of Virtual Reality applications still use traditional VR authoring packages (Virtools, 2007; VR-Juggler, 2007) or write everything from scratch. These approaches provide complete flexibility for the author/programmer, but require a great deal of time and effort to achieve basic effects. Furthermore, the resulting graphics are significantly inferior to those generated by the game engines. Accordingly, a small but growing number of VR authors are using game engines for their applications (Lewis 2002).

### 2.3.3 Flight Simulators

The modern history of Virtual Reality began in the 1960's with the flight simulator, an artificial aircraft cockpit with video screens instead of windows. The pilot "flies" over a computer-generated landscape using controls which simulate the action of real controls (Ellis 1991). Many simulators are mounted on mechanized platforms which tilt and roll to simulate the motion of a real aircraft cockpit. The experience is real enough to justify these devices' long history and wide use for pilot training. Recently, simulators have been used in such disparate fields as truck driving, tug-boat piloting, and mining equipment operation to provide basic training on the use of heavy equipment.



**Figure 6.** Exterior (left) and interior (right) of a flight simulator (Simlabs 2006)

### 2.3.4 Head-Mounted Displays

In real life, the left eye sees a slightly different view of the world than the right eye, simply because they are separated by a few inches. The brain exploits this difference to produce a strong visual cue for depth at near distances, an effect called *stereopsis*. A Head Mounted Display (HMD) can simulate it for a virtual world by holding a small video screen in front of each eye. Each screen shows a similar view of the virtual world, but the viewpoint for each screen is offset a small distance in the virtual environment, creating *stereopsis* for the user.

In the HMD, both images change based on where the viewer is looking. Coordinated with a device for tracking the viewer's head movements, the software driving the displays on the HMD's screens determines the direction and location of each of the viewer's eyes in the virtual environment. For example, if the application begins by showing the viewer a scene, and the viewer turns his or her head slowly to the left, the scene the viewer sees in the HMD changes in just the same way a real one would. With proper calibration, the HMD creates the illusion that the user is entirely within the virtual world, and can see different views of that world by looking in different directions.



**Figure 7.** Two HMDs (left) from Cybermind (2006) and (right) from Virtual Realities (2006)

Generally, HMDs are the least expensive of the classic stereoscopic displays, popular among VR users. However, the HMD rarely offers a wide field of view, usually showing less than thirty degrees in the horizontal dimension. The user can turn his or her head to see more, but effectively has tunnel-vision in the virtual world. While this is less restrictive than it may sound,

it is a real limitation. Another disadvantage of the HMD is that it cuts the viewer off from everything not mediated by the computer and makes direct visual person-to-person social interaction impossible. We mistrust devices which subtract from the human experience so sharply. Perhaps that is why Figure 7, above, is disturbing. The man on the left looks as if some boneless sea creature is gripping his face, and the man on the right looks like his is a menacing cyborg.

### 2.3.5 Flat-Screen Projection-Based Immersive Displays

Around 1991 at the University of Chicago, Sandin and DeFanti developed the "CAVE," an immersive electronic display, which operates on the same general principle as the cyclorama (Cruz-Niera 1993). A single viewer stands in the center of a partial cube, where each wall is a rear-projected screen, effectively a very large computer monitor. The image on each screen is part of a larger panorama. If the image on each screen has the proper perspective correction, all the images together appear to the viewer as a single contiguous landscape. In the VR research community, the acronym "CAVE" has evolved into the general term, *cave*, in the VR community to refer to any multiscreen enclosure with similar properties



**Figure 8.** User in the SAS-Cube, exploring a virtual nightclub (ALTERNE 2005).



The CAVE supports a stereographic view for the user by projecting both the right- and left-eye views onto the screens at the same time. The viewer wears special glasses, which filter the images so that each eye receives only the image it should. The lens over the left eye blocks the image intended for the right eye but lets the left-eye image through. The right-eye lens does the opposite, and the final result is a single stereographic view. Furthermore, an electronic tracking device makes the computer aware of where the user's head is located, so that it can adjust the perspective on all screens as the user moves. This preserves the illusion while allowing the viewer to look around and walk around in the CAVE.

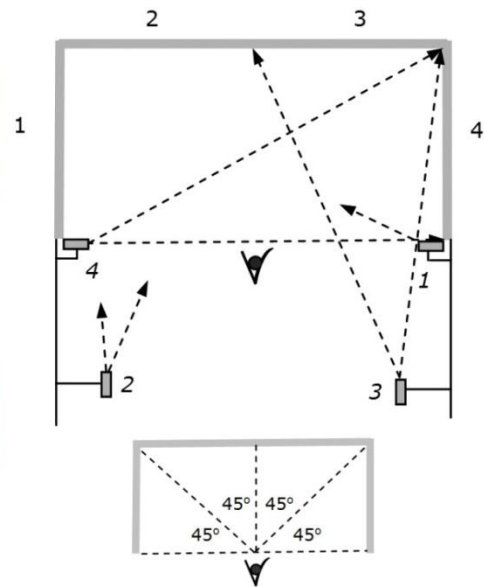
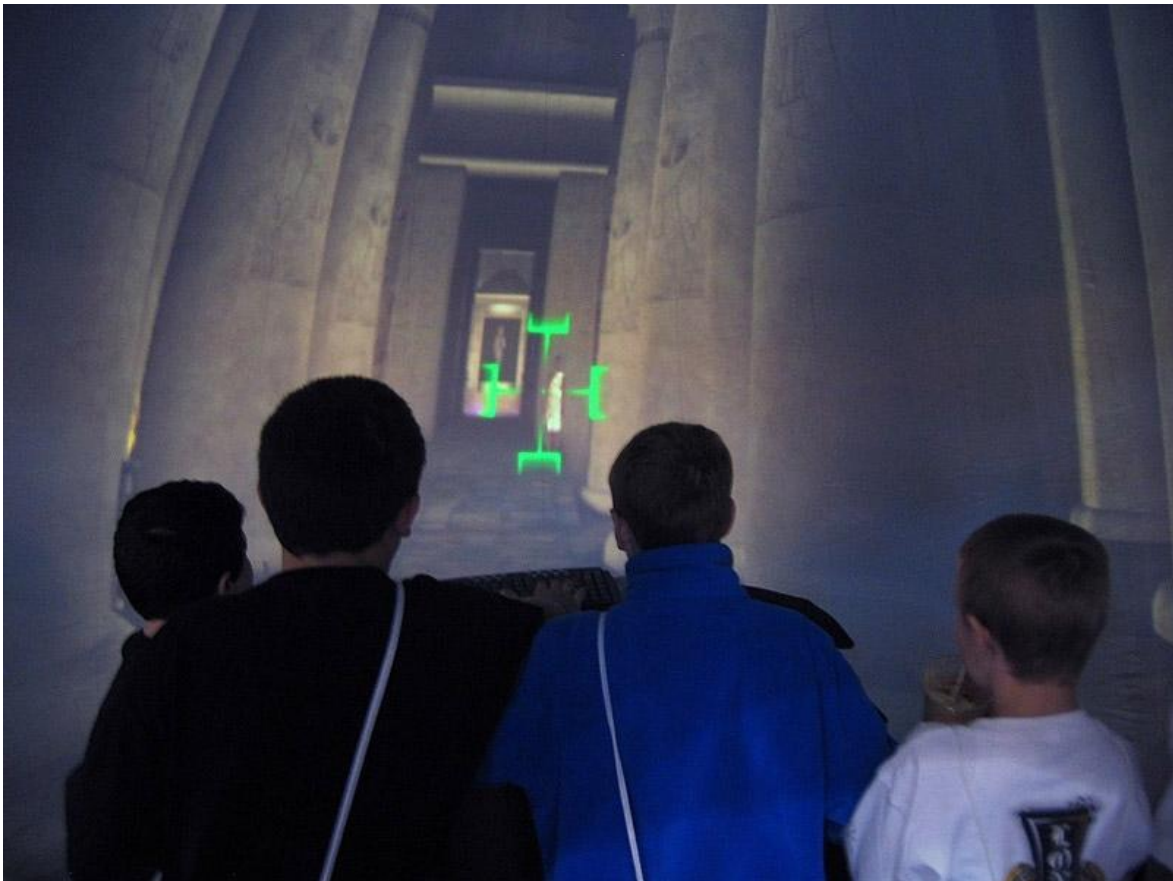

**Figure 9.** The Virtual Theater (Jacobson 2005c)

While stereoscopic caves remain expensive, those which produce a monoscopic (normal) video image have become much cheaper recently (Pape, 2002; Jacobson, 2001, 2005i; Blake, 2003; PublicVR 2008). Though they do not present the optimal display, nonetheless they can be very useful and cost-effective (PublicVR 2008), especially for applications where the objects of interest are some (virtual) distance from the user. In real life, the stereographic effect diminishes with distance.

### 2.3.6 Digital Dome Displays

Digital dome displays evolved from conventional planetaria and offer an impressive degree of visual immersion, without stereo, head-tracking or any other special equipment. The curved screen eliminates seams and minimizes perspective distortions as the user moves his or her viewpoint. Most installations are large, allowing many viewers at one time. Recently, there has been an effort in the technical community to provide interactive content for these displays (Elumens, 2001; Elumenati, 2008). The cost of building these displays has decreased, and software makers are providing an ever-widening range of content-generation tools which can be used in them (Softimage, 2001; Multigen, 2001; Web3D, 2004; DomeUT 2006).



**Figure 10.** Dome display at Digital Life (2006) courtesy of the Elumenati (2008)

### 2.3.7 Direct Retinal Imagers

These devices employ a very low-intensity laser which literally draws an image directly on the retina of the viewer's eye. In this way, the laser uses the retina exactly like a projection screen (Schowengerdt, 2006). A retinal imager looks like a simple headset or glasses with some attached machinery. One or two small devices point at a small mirror in front of the user's eye. In practice, they are able to produce a simple image in a small area of the user's field of view, but the resolution is low and is nothing like a panoramic view. However, a retinal imager is excellent for applications where the user needs to see information superimposed on his or her field of view. For example, a mechanic working on a jet engine could see a schematic of the engine's internals superimposed on his view of the real engine. They are also used in certain medical devices.

### 2.3.8 Interaction Devices

A crucial dimension of VR is how the user employs control devices to interact with the virtual environment. VR and VR-like applications can be driven using the simple keyboard-and-mouse interface, or widely available game controllers like joysticks, gamepads. However, the traditional VR applications use more advanced devices which give the user a more direct feeling of interaction with the virtual world and the things in it. For a good taxonomy of these devices and how they can be used, see Bowman (2002). We present two examples.

Some advanced applications use a kind of *wand* or *control stick* like the one shown in Figure 11, below. (There is no established term for these.) The wand contains a magnetic tracking device which allows the computer to know its location and orientation in space. The programmer then maps movements of the wand into effects in the VR application. For example, the user could point the wand in the direction of some object in the virtual environment. Then, the user could press a button to capture or "grab" the object. In our example, the user could then move the captured object in space by moving the tracker. Every movement of the tracker is imitated by the captured object. The user would release the object by releasing the button.



**Figure 11.** IS-900 MiniTrax Wand Tracker (Intersense 2006)

Another classic VR interface device is a special glove which not only has a location and orientation tracker, but can read the posture of each finger on the user's hand Figure 12, below. In some applications, a computer graphic image of a hand in the virtual environment shadows all of the motions of the real user's hand. The virtual hand can touch an object, grab it and move it around. In some gloves, actuators in the inside of the glove squeeze the inside of the user's fingers, gently, in the places where the virtual hand is touching the virtual object. The effect is the illusion of feeling the virtual object. Importantly, the glove also enables the user to give commands to the computer by making specific gestures.





**Figure 12.** CyberGlove (Metamotion 2006).

There are several types of stylus, pen-like devices, one holds like a pencil or scalpel. It is attached to motors and sensors which allow the computer to know where the stylus is in space and where it is pointed, just like the glove. However, the accuracy can be very great and a motorized stylus can really push back when the user encounters a virtual obstacle or substance, giving a point-sense of touch. Styli are used in surgical simulations, good for training doctors in delicate surgery without risk to patients and without the limitations of cadavers.

Finally, a wide range of interface products use optical trackers, most of which determine where some special marker object is located simply by looking at it through dedicated cameras. For example, a dancer can wear a full-body suit with lights on every joint and some other spots. A good visual motion tracking system can observe the lights as the dancer moves and record their relative motion in 3D space (Welch, 2002). Then, the recording, or real-time data stream, can be used to move some avatar or agent in a virtual world. Some very advanced systems can track a whole person without the need for markers (OrganicMotion, 2008). The same systems are used to capture human motions to produce high-quality 3-D animations.

### 2.3.9 Online Communities

Massively multiple online communities (MMOs) are becoming increasingly important in education (Dede, 2004). In an MMO, a large number of participants use DesktopVR on their home computers to join a shared virtual environment, a 3D computer graphic world they access over the Internet. Each person controls a 3-D model or *avatar*, usually humanoid, which represents the player in virtual world. A window on the user's desktop (or the full screen) shows that avatar's view, and is the player's main viewpoint to the virtual environment



**Figure 13.** An avatar in Second Life conversing with the user.

Figure 13, above, shows a view that the user might see when conversing with a female avatar in the foreground. Actual conversation in MMOs can be typed text (online chat) or voice, enhanced by the visual context. Context includes the appearance of the environment and the interaction rules which govern it, as well as the locations of the avatars and objects within it. Combined with body language, facial expressions, social motion, and location in a complex space, participants in the MMO can have a rich way to communicate.

In recent years, general purpose MMOs, such as Second Life (2008) and There (200?), have attracted great attention from the general public and the mainstream media. Major corporations are setting up “areas” for themselves within Second Life, and important organizations are having virtual meetings there. Advertising in Second Life is becoming ubiquitous. All of these changes have been difficult for the Second Life community to digest, leading to some conflict. That conflict and the difficulty of upgrading to more current computer graphics software pose a significant challenge to the survival of this particular enterprise. Nevertheless, this paradigm of interaction will continue to evolve and become increasingly important in human social communication.



**Figure 14.** Player avatars in World of Warcraft, a popular MMORPG

The technology for online virtual communities began as games, and the best technology and the majority of the users continue to employ the technology for game-play. MMORPG is an acronym for "Massively Multiple Online Roleplaying Game" where a fictional theme imposed upon the players and the environment, such as medieval European folklore or Star Trek. See Figure 14, above. The avatars come into the environment with particular traits appropriate to the

milieu and are usually called characters. Game goals vary, but usually involve gathering treasure and power, fighting wars or solving mysteries. MMORPGs have reached a wide mainstream audience, becoming a very large business. There are actually real people making real money by playing these games to build up characters to a desirable level of ability, which they then sell to new players. Other users are *crafters*, players who make objects for other players to enjoy at a real and/or virtual price.

We predict that visual and sensory display will become more important in MMORPGs and their successors. Soon, immersive virtual reality and the massively multiple online games will merge, giving users a wide range of displays from which to choose.

### **2.3.10 Augmented Reality**

A close cousin to VR, Augmented Reality (AR) is the practice of using VR techniques to enhance a real, physical, space (Papagiannakis, 2004a, 2004b; Ruiz, 2002; Sinclair, 2001; Addison, 2002). For example, AR Quake (Piekarski, 2002) has the user look at the world through special glasses. Animated autonomous agents are added to the user's view by having the computer “paint” the appropriate imagery onto the surface of the glasses. The agents interact with each other, the terrain and the user. With “Hippie” and related applications (Oppermann, 1999; Baber, 2001) the user hears a topical narrative when approaching a point of interest in a museum. The narratives change, adaptively, depending on who the user is and what the user has seen before. It could be said that there is a continuum of possible applications from pure reality to a fully virtual environment, with the term “Augmented Reality” including most things in between.

## 2.4 ADAPTIVE HYPERMEDIA

An interactive device is said to be adaptive if it automatically changes its appearance and/or behavior to better suit the user's needs and goals. A great deal of research has been devoted to adaptive hypermedia, (Brusilovsky, 2001, 2004). Hypermedia applications are widespread and important (e.g. the World Wide Web). Many hypermedia applications are used by people who differ in ways that have an effect on the application's usefulness. This is especially true for educational applications, because student demographics can vary widely and a students' prior knowledge has a decisive effect on any learning activity (Bloom, 1956).

Most of the Virtual Heritage applications described in section 2.7, p76, are part of some larger web-based hypermedia application. Unfortunately, few of them have any capability to adapt to the user's particular actions or needs (Kameas, 2000). Even so, adaptive methods have been applied successfully to other educational media. The addition of adaptivity to Virtual Heritage applications is an important and useful step for VH developers. Techniques from adaptive hypermedia (AH) have been proven to be effective, and are therefore not difficult to implement.

A significant portion of the adaptive hypermedia research is aimed at educational applications (Brusilovsky, 2003c; Cristea, 2004; Garzotto, 2004). Many of these applications use a Desktop VR interface, make adaptive changes to the 3D virtual environment itself (Chittaro, 2003, 2004) or influence user navigation (Hughes, 2002). Finally, there are hypermedia applications which use adaptive narratives to augment a real, physical space, (Oppermann, 1999; Specht, 1999b; Not, 1998a, 1998b; Sinclair, 2001) which is a form of augmented reality (Baber, 2001).

### 2.4.1 User Modeling

The behavior of an adaptive device is usually governed by some implicit or explicit model of the user. Researchers in Artificial Intelligence (AI) developed many of the formal methods for user modeling and information accessing tasks, such as dialog systems (Chin, 1989; Johansson, 2002) and web-navigation systems (Levy, 2000; Weber, 2001). The user model is developed from information about the user which the program is able to gather or infer (Brusilovsky, 2001, 2004; Torre, 2001; Bra, 2000). There are several ways to gather and/or infer that information.

The simplest is for the instructor or operator to provide information about the user to the program before startup or for the program to ask the user for the information it needs. In a formal educational setting, a questionnaire may be appropriate. However, many users outside of the classroom will only tolerate a few questions.

A more sophisticated method is to observe the past behavior of a particular user. The program can record usage behavior as an important clue to the user's goals and preferences. For example, many automated online retailers make buying recommendations to the user based on his or her previous purchases. Alternatively, applications can keep a history of the points of interest (physical or virtual) that the user has visited and adjust its behavior to match. The application can also incorporate information about the tasks the user must perform to achieve his or her goals. Then, the application can attempt to assist the user by adapting in ways that make the user's tasks easier (Garlatti, 1999).

Based on the information gathered, a hypermedia application can infer a great deal about the user by matching that information with a pre-existing database of user stereotypes (Rich, 1989). For adaptive hypermedia, a stereotype is a set of facts about a hypothetical user who belongs to some demographic group. Key facts identify a user as probably matching some stereotype. For example, a forty-year-old college educated person is likely to ask for a different explanation of what a giraffe is, than the typical six-year old. Information gathered during the use of the software can refine the stereotype, either generally or with respect to the current user.

Several studies feature learner stereotypes based on different learning styles (Danielson, 1997; Mammars, 2002; Kim K, 1999; Bruen, 2002; Carver, 1999). With stereotyping, a great deal of information can be inferred quickly. However, none of it is certain, so it is best for the application to keep track of inferred facts and change some measure of each one's validity based

on supporting or counter-evidence. A practical example is SETA, an application which helps retailers to tailor their online stores to specific user stereotypes (Ardissono, 1999).

Another way to gather information about the user is through collaborative recommendation (Balabanovic, 1997). Actual users of the application are grouped by stereotype, behavior, or in some other way. They are then asked for recommendations which are evaluated partially on the basis of stated or observed preferences of individual members of that group.

Though stereotyping has proved to be useful, it is never completely accurate and can sometimes be misleading. Also, the stereotype groups can overlap considerably making the rules of determining which is appropriate for a particular user quite complex

## **2.4.2 Methods of Adaptation**

The term “hypermedia” usually refers to computer applications in which an information space is rendered into discrete portions; the user navigates this divided space by “moving” from a view of one portion to another through some built-in mechanism. The most common of these is the hyperlink, (e.g. a URL on the Web) although more advanced mechanisms are common, including search-by-query, map-based navigation, and the traversal of some three-dimensional visualization. Regardless of the mechanism, the underlying principle is that the user is navigating through a predefined information space. In the Adaptive Hypermedia literature, the value of adaptation is generally regarded as positive. It is seen as a method of guiding the user in navigating the information space by changing, helping or hindering the user to navigate in some informational directions and not others.

One of the simplest ways to make hypertext adaptive is to change the links. Since hypertext is connected by links, changing links redefines navigation in the information space. This should only be done with great care, because the user is likely to have already built at least a partial mental map of the information space based on the defined “modules” of information s/he has encountered when first entering a particular VR application. If it is decided that the linking structure can be altered within an application, it is generally more acceptable to users to add links rather than to remove them. For example, an adaptive labeling application, like ILEX (Cox, 1999), will simply display more of an information module to the user if it deduces that s/he is ready for more detailed levels of information.



Another adaptation is to change the appearance of the display. The change can emphasize some information and/or links and deemphasize others. The adaptive mechanism can be simple, like reordering menus or highlighting certain items within a list. More advanced applications have also been developed. . For example, KnowledgeSea (Brusilovsky, 2002) has a large number of links attached to an abstract map a selected subject area. Regions within this area can change color, depending on the number of visitors and other factors. Another example, is *Gates of Horus* (section 3.3, p98) our own learning game. When the cursor is over an active object, it changes color, indicating that the student can select it to trigger an action.

Advanced hypermedia may use more sophisticated adaptation methods, such as complex rules to determine the appearance and behavior of the interface (Bra, 1999; Brusilovsky, 2004). The adaptive media application may also change its rules to accommodate the user either before or during a particular (usually user initiated) operation.

Recently, there has been interest in meta-adaptation, where higher-order rules determine which more specific and “lower level” adaptive rules are invoked to assist the user. Brusilovsky (2003a) did a post-hoc analysis of three previous AH experiments, which showed unmistakably that different students needed different kinds of support in learning media. He found that students new to some material needed a great deal of guidance, preferring to stay on some predetermined path which navigated through the subject matter presented within the application. Other students, who possessed significant prior knowledge, tended to “jump around” in the information space a lot more, interrogating the interface for specific pieces of knowledge. Brusilovsky (2003a) and Assis (2004) emphasize the importance of this problem and suggest certain meta-rules which can be used to design an application’s navigation and display strategies depending on measures which attempt to assess the level of the students' prior knowledge. Torre (2001) describes a framework for user modeling which could be used in dynamic modeling.

In the strategies described above, the user is not directly notified that changes are made to a particular application’s interface. Indeed, in some designs, the user may not realize that changes have occurred at all. However, there are other strategies which depend on the user being aware that adaptations occur while the user is engaged with the application. For example, the adaptivity in an AH application may be embodied in one or more autonomous agents, as in broker and advocate agents in recommendations system which offer advice or suggest opportunities to the user (Manouselis, 2002). For example, friendly agents may give advice to



the user about which path to take or may even “bring” information directly to the user (Rhodes, 2000). An autonomous helper or tutor agent may even embody adaptive behaviors which serve to assist the student (section 2.7.5, p82).

Most adaptive navigation applications present the user with a finite information space. However, researchers have recently begun to experiment not just with adapting the method in which the user navigates the information space, but also adjusting the size and nature of the information space through which they navigate. Brusilovsky (2001) points out that most of the existing hypermedia applications provide the user with a static information space which allows the designer to build all the links and rules ahead of time to take advantage of the particular “geography” of the information space and of the goals of the potential users. Alternatively, the rules of adaptation can themselves be changed in real-time, a kind of meta-adaptation (Brusilovsky, 2003a). Applications based on a changeable information base are more difficult, especially with the World Wide Web (Carver, 1999b). Users must be given some explanation of the overall structure and meaning of the subject matter they are navigating. This is much more difficult than it may initially appear. Many initial attempts were not successful, although some success has been reported.

### **2.4.3 Some Applications**

Most existing adaptive applications use text, imagery, animations and other visual strategies, though all of these displays are limited to two spatial dimensions. For example, a virtual museum is similar to a traditional hypertext museum guide with adaptation added, providing the kind of information one usually finds in a physical museum’s catalogue (Bertoletti, 1999, 2001; Cox, 1999; Oberlander, 1998; Milosavljevic, 1998).

Some adaptive applications seek to lead the viewer along a single path through the information space, but tailor the path based on the viewer's knowledge and interests. For example, students may work their way through a curriculum which adaptively changes to suit their needs, based on predetermined rules set by and instructor and presumably under the instructor's supervision (Brusilovsky, 2003b; Tan, 1997; Specht, 1997; Nykanen, 1998).

Virtual museums and adaptive course-ware are special cases of such expert systems, in that they give the user information at least partially based on what the tutoring system determines

s/he knows. The static precursor to this is a simple list of instructions, where each instruction assumes the ones before it have been followed. An adaptive system will have much more complex ways of responding to the user and guiding him or her towards some knowledge goal. While it is possible to embody the tutoring system in a static hyperlinked structure, such as the primitive expert systems, it is far more effective (and far more difficult) to use techniques developed in Artificial Intelligence research to determine the knowledge space and the informational paths through it.

#### **2.4.4 Augmenting Virtual Space with Adaptive Behaviors**

An information space embodied in an adaptive application can often be expressed as a three-dimensional virtual environment. The user can query this 3D interface in a variety of ways. In some cases, part or the whole of the environment can change depending on the user's perceived needs. For example, a virtual or physical space can be augmented with audio clips of information (Oppermann, 1999; Sinclair, 2001; Not, 1998b). The content of these clips may change depending on which user model the user is determined to belong to and where s/he has been in the VE, (Petrelli, 1999). This technique is particularly useful for museum-like environments. A more advanced approach is to generate automatically different versions of the virtual environment based on the user's current perceived need (Chittaro, 2003, 2004).

An entirely different adaptive strategy is to change the way in which the user navigates within the virtual environment in a dynamical fashion. For example, going around a corner to see what is there is can be regarded as a kind of spatial query. There are a number of feasible methods to constrain or deflect the user's movement through the virtual space, so that s/he is either encouraged or required to notice certain things or to emphasize certain trajectories (Brusilovsky, 2004). One way to do this is to use "guide agents" who recommend the direction of gaze or movement (Hughes S, 2002a). Examples include a moving spotlight, a floating arrow that stays in front of the user, points which serve as a compass (Hughes S, 2002a) and a lifelike guide agent who leads the user in particular direction or indicates points of interest (Chittaro, 2003, 2004).

In yet another level of adaptation, the "guide agents" themselves may be programmed to change their strategy depending on the perceived needs or interests of the user and based on the

overarching narrative structure of the application. This is especially common in games, where agents often populate a virtual landscape or social environment. They can change their behavior depending on who the user is supposed to be or on events that occurred before the user's avatars encounters the agent.

#### **2.4.5 Augmenting Physical Space with Adaptive Behaviors**

A variety of methods exist to guide the user through physical spaces using recorded or generated narratives. The narratives can be heard on speakers, in mobile tape recorders, read on location-sensitive PDAs, or delivered by other means. Using HyperAudio, for example, the user can hear a narrative explanation of some object when s/he nears it (Oppermann, 1999; Specht, 1999b; Not 1998a, 1998b; Sinclair, 2001). These narratives can be made adaptive, changing according to the users' prior interaction within the environment, learning goals and other factors. For very large physical spaces, adaptive applications are typically implemented with some kind of Personal Digital Assistant (PDA) for the user and some means of determining the user's location. This allows the application to make travel recommendations, give instructions for physical navigation, reveal historical information, and so on (Sendin, 2002; Cheverst, 2000). All such strategies can be modeled in virtual environments or employed for use in VE-based applications.

Adaptive educational applications (immersive or not) can be more learner-centered than static educational software. This is also true for pedagogical agents, who are more lifelike and functionally helpful if some kind of adaptive intelligence can drive their behavior.

#### **2.4.6 Learning Games**

The game paradigm is an excellent way to center interaction on the user in a flexible virtual environment. Since the nineteen-eighties, educational researchers have studied how the structures and methods used in extremely popular computer games could be harnessed to promote learning in a variety of fields. Today such efforts are attracting even more interest and resources (Squire 2003, 2007; Kirriemuir 2004; Repenning, 2005). Games usually are based on a

microworld of some sort and almost invariably use goal-seeking activities to motivate the user to explore this “world” (Champion, 2004b; DeLeon, 2000). Similarly, immersive VR interfaces often use goal-seeking strategies to shape interaction with many types of virtual environments, especially those with a high level of visual fidelity.

Today, computer games are a very common part of popular culture, with millions of people playing them. Through video games and other electronic media, many users have developed a high degree of video literacy, comfort and competence with fast, information-dense input. Also, the game industry has developed powerful, flexible software that can be adapted for educational use—indeed, much of it has already been adapted to Immersive VR (Squire, 2002; Kirriemuir, 2004; Jacobson, 2005). These developments put many types of educational virtual reality within reach of educators and their institutions (Lewis, 2002; Dondlinger, 2007). The key advantages of game-based learning are:

1. the student/player's intense investment in reaching a goal defined by the educator designer.
2. continual feedback for the student as s/he interacts with the system,
3. a high degree of student involvement and investment in the activity itself

We believe that educational games are a special case adaptive media (Brusilovsky 2008) and are well suited to both *Constructivist* learning activities (section 2.5.1, p42) and to Virtual Reality.

**The key is to make the goals of the game serve the students learning goals and the broader curriculum.** The student would benefit little if an educational game is designed to be some kind of a wrapper around the information s/he is expected to learn. In these cases, the student might play the game for its own sake and quickly forget the subject matter. It would be easy to design a game in which the student gains points for solving riddles or remembering facts. However, it would be much more effective if the goal of the game was to accomplish something within the context of the subject matter. Winn (2001) provides an excellent example of a good conceptual design; in his study, students adjust environmental factors in a simulated part of the world to find an optimal solution to global warming. This activity is definitely a game, although Winn does not describe it as such, neither in the instructions given to his subjects nor in the paper describing his experiment. The students simply enjoyed and learned.

In our study, we structured the student learning experience as a game.

## 2.5 LEARNING THEORY AND VR

In the following discussion we will explore how the educational theories that were developed in the field of Artificial Intelligence now inform the development and use of immersive VR in education. Other studies have addressed this topic, and they are usually they are shaped by educational theory of *Constructivism*, in which students learn best through an active self-directed curriculum. Most investigators believe that the expressiveness and flexibility inherent in all types of VR (not just immersive) supports this style of instruction.

Further, many of these scholarly works endorse the idea that sensory immersion produces a feeling of *presence* which enhances engagement and therefore learning; we believe the truth is more complex (section 2.5.3, p47). Another major justification for using Immersive VR in teaching is the idea that VR is a powerful means of expression, encoding a great deal of information with which the user can interact directly. Most arguments for this are based on the *Ecological* (Gibson, 1979) approach to understanding the mind, however others are firmly *Cognitivist*. As will be discussed below, some of the literature on this topic uses the concept of *Distributed Cognition*, which begins to combine the Cognitivist and the ecological approaches. The goal of all of these approaches is to give students enough flexibility to support their own learning, but to do so in a way that can be measured objectively. At the end of this section, we will present Dr. William Winn's synthesis which we have expanded and modified to produce the core of our own investigational theory.

### 2.5.1 Constructivism

Constructivism has been central to the way most researchers approach educational VR, particularly in 1990's (Fallman, 1999; Dalgarno, 2001b, 2002a, 2002b), while more recent theory and work (Winn, 2003a; Moreno, 2002b; Mayer, 2001) combine Cognitivist approaches with Constructivist concepts. Unfortunately, much substandard work has claimed a Constructivist underpinning (Jonassen, 2000a; Land, 2000). For example, many 2D multimedia learning applications developed during the 90's claimed to be Constructivist, but do not give the student enough autonomy to direct their own learning (Land, 2000). Efforts to use VR and Immersive VR have a similar range of quality. As with all media, the technology does not solve problems so much as it creates opportunities. This section describes constructivism as it is presented in the educational VR literature and in Jonassen (2000a).

One of the central tenets of Constructivism is that the learner defines the learning environment. Individuals respond not to some fundamental reality, but to their own context or “Umwelt,” the environment as the user perceives it (Winn, 2003b). For example, people from warm climates imagine snow to be a uniform material, while the Inuit peoples regard it as an extremely varied phenomenon which they describe using many different words (Jonassen, 2000a; Land, 2000). Part of this context is the body of information that the student already knows. If education is to be successful and relevant), the learner must actively connect the new knowledge presented in the learning experience to the knowledge into their own preexisting knowledge context (Bloom, 1956). This process requires both self-knowledge and knowledge of the environment. For example, a business student must understand how to apply his or her unique advantages in the cultural-economic setting where s/he expects to be successful.

Constructivism not only stresses the student's “Umwelt,” but it also sees knowledge acquisition as part of a larger social process of discovery and negotiation whose outcomes are encoded in cultural artifacts (Land, 2000; Vygotsky, 1978; Furness, 1997; Winn, 1999b; Osberg, 1997a; Jackson, 2000). This is how language, religion, culture, technology and science all came into being, and they necessarily form much of the learner's environment. To paraphrase (Jackson 2000):

In Constructivist theory, learning is rooted in specific situations and their cultural artifacts. Ideally, instruction should be centered in a community of learners who collaborate to create their own curriculum (Brown and Champion, 1994; Driver, 1995). In McLellan's (1996) view of "situated learning," knowledge is encoded into the environment and developed by the activity, context and culture of the students.

For example, when students work on group assignments, they must come to a common understanding of what relevant material forms the underpinning of the task at hand and also of the strategies and tools that can be used to accomplish it. When students study together for assignments, they negotiate the meaning of the relevant material as a way of pooling their intelligence to better approximate what they believe the teacher wants them to know. In Activity Theory, this is called the "co-construction of shared knowledge" (Vygotsky 1978, Jonassen 2000b, Jackson 2000). Hay (2000) calls it "investigation-based learning."

Constructivism is not simply a theory about the personal and social nature of knowledge and understanding; it also provides the underpinning for learning strategies. A major goal of the Constructivist approach is to teach students how to learn. However, proponents of the Constructivist approach also admit that instructors cannot fully know their students' minds and students often learn without specific instruction. Students must develop personal strategies for learning, and it is generally agreed that students learn better if they feel they have some ownership of the learning process (Furness, 1997). A Constructivist educator helps the students during the discovery and meaning-making processes. An effective instructor provides learning tools and initial information, sets overall goals, monitors students' progress, provides additional materials when necessary and resolves problems. The students themselves frame the intermediate problems, set their short-term goals, and develop the skills they need to achieve the larger goal. According to Constructivist theory, these skills can often be developed within the framework of some assigned group learning project. The intent is to teach goal-making, planning, evaluation, and especially self-evaluation techniques, all skills which are necessary for the students to be successful in later learning.

Constructivist learning can be seen in terms of the student's *Zone of Proximal Development*, (Vygotsky, 1978; Jackson, 2000) which includes learning activities which the student can do, but only with assistance from an instructor. The student can perform the simpler learning activities "below" the zone without help, while activities "above" the zone are too complex for him or her, even with instructor assistance. When the student is performing tasks in



his or her “proximal zone”, s/he exercises abilities that are still forming, which is when learning is most effective (Vygotsky, 1978; Jackson 2000).

Similarly, the *Bi-Directional Zone* of development (Forman, 1989; Jackson, 2000) describes those activities which students can perform, but only by working together with other students, and thereby scaffolding each other's learning. Collaborative learning is especially useful, because teamwork itself is a critical workplace skill (Vygotsky, 1978; Roussou, 1999; Jackson, 2000).

Project-based learning is an important part of the Constructivist approach. Instructors often facilitate learning by assigning group projects to their students, project-based learning. Papert calls this approach Constructionism (Hay, 2000). Project-based learning supports “multi-level engagement/activity, challenge and structure,” and that student engagement is stronger when the students have authorship in the goals of the project and the final product itself (Furness, 1997; Roussou, 1999).

Finally, Constructivist practice places great value on the necessity of choosing the level of “authenticity” that is appropriate to the learning task at hand. Concurrently, the wider literature about Immersive VR places great importance on the medium's ability to create virtual environments which faithfully represent aspects of the real world. Researchers in educational Immersive VR are particularly interested in learning environments which are “authentic”, “naturalistic” or even "realistic", because, if these types of “worlds” can be created, students can be placed in an environmental context which is familiar to them and which can be made relevant to their learning goals (Furness, 1997). On one hand, such environments must be information-rich, containing enough of the right detail to be realistic (with respect to the learning goals). On the other, they must be as free as possible of irrelevant features. Jackson (2000) calls such applications “selectively realistic.” However, Jonassen (2000a) warns of “reductive bias”, which leads learning exercises to be excessively or inappropriately simplified.

It is worth noting that roughly half of the empirical educational Immersive VR experiments in this survey explored the teaching of children in public schools. The majority teach science subject matter, such as physics, geology or astronomy, which present significant educational challenges.

They all claim to employ Constructivist learning principles to achieve "Conceptual Change" (p53) in the student. Their success in providing a truly Constructivist learning experience varies,

however, as shown in section 2.6.4 (p66) Also, equal numbers of the Constructivist learning experiences in the experiments were constructionist (learning by making something) or experiencing (primarily exploration and inquiry). Two experiments (Winn, 1997; Roussou, 1999) were both—students built small virtual worlds and other students experienced them.

## 2.5.2 Direct Interaction with Information

According to much of the VR literature, the user interacts directly with information, with no intermediary, bypassing symbol systems. It is often said that the VR interface “disappears,” freeing the user to concentrate on the subject matter (Bricken 1990, 1992; Winn 1997b, 1999a, 2001, 2003b). This view is inspired partly from the Ecological Cognition model and its heirs which posit that users are directly aware of their environment, indistinguishable from it (Gibson 1979). This model assumes that information embodied or embedded in the environment is directly accessible to a person's mind—it can be viewed as the external component of a larger cognitive process (Gibson, 1979). Proponents of this view argue that a VR-based environment can embody information that is encoded in a form directly available to the user's sensorium-in effect making the information directly accessible to the user's cognitive processes. In this sense, there ceases to be any interface between the user and the information.

Dr. Winn often stated that, with Immersive VR, the interface effectively disappears, thus freeing the student to concentrate on the subject matter (Winn 1997a, 1997b, 1999, 2001, 2003b). In Winn (1999) he specifically states that VEs allow direct construction of knowledge, “bypassing symbol systems.” The VR-as-direct-information view is widely held by authors in the general VR literature, a good example of this is Merideth Bricken's often cited article “Virtual Reality; No Interface to Design” (Bricken, 1990).

Unfortunately, this model does not address the gap between the information the designer means to convey and the way it is expressed in (or as) a virtual environment (VE). For the user to “directly perceive” the basic information that the educational VE is intended to convey, a perfect conversion of the information into some sensorially accessible form would be required. Such a conversion is impossible. The only information that the user can access directly in the Ecological sense, is a *representation* of that information; and that representation is created by some person or some process defined by the author of the virtual environment.

The correspondence between the data and the representation may be very close in some cases, for example in a visualization of a storm front from atmospheric data. Even there, however, design issues have a vital effect on the way the user perceives the information because the design of the representation is not intrinsic to the information itself. In our example, the colors assigned to different regions of air pressure could have a significant effect on how the user reads the visualization.

At the other extreme there some information can only be represented with some arbitrary symbol system, for example the text on the road signs in some virtual village. Many successful future VEs will be some mixture of representation, symbol, iconography and metaphor. The use of representations to construct an environment or artificial reality raises important ontological issues (Heim, 1993; Koepsell, 2000).

Nevertheless, authors in the literature are well aware that the expression of information in a VE must be tailored to its purpose, to the limitations of the technology and to the demands of the human sensory and intellectual system. For example, Furness (1997) says that the design of the VE influences how the user interacts with the information which in turn influences the way s/he interprets it. Winn (2003b) reports that students using VR to learn about global climate change learned more than control group about ocean currents, but learned no more about salinity levels. He attributes this to the design of the representations used in the learning application. Furness (1997) states that VR can be used as a medium for a wide range of symbol systems, which is useful because different symbol systems activate different mental models in memory. He also states that "...some less 'abstract' symbol systems allow more direct construction of conceptual and propositional knowledge." (Furness, 1997). Among VR theorists and practitioners, there seems to be agreement that varying interpretations about such issues of representation are unavoidable.

We believe that (1) everything in a VE is some kind of representation, (2) the user perceives those representations as part of his or her environment, and (3) that VR derives its expressive power from the wide range of possible representations and the ability to combine large numbers of them into a single coherent presentation.

### 2.5.3 Presence and Engagement

The sense of *presence* is a critical component of VR (Zeltzer, 1992) and without it, an immersive learning application cannot be successful (Winn, 2003a). The users would learn nothing, because they could not understand the information presented by the application's interface. Accordingly, nearly all experiments with educational VR test for presence, using a variety of measures.

In the existing VR literature, a key argument for using sensory immersion in an educational application is that this would produce a significant increase in student engagement with the subject matter (Furness, 1997; Dede, 1999; Osberg, 1997a; Jackson, 2000; Winn, 2003a). In many studies, the degree of *sensory presence* (section 2.1.1.5, p6) was positively correlated with student learning and enjoyment (Dede, 1999; Salzman, 1998; Winn, 1997a, 2001). However, there are many other ways to enhance student engagement with the learning activity, with interaction being the dominant factor. Non-Immersive VR can also enhance engagement (Cobb, 2002; Dede, 2004; SecondLife, 2004; There, 2004) chiefly by raising *thematic presence* (section 2.1.1.4, p6).

A stronger reason for using Immersive VR in education is that it allows the student to interact with the information in a way that is both meaningful and not otherwise available. As with other media, a VR application is successful to the extent that the particular advantages of the medium are an explicit part of the information design. For example, Salzman (1998) performed a successful learning experiment where students manipulated a model of an electric field in an immersive display. In that study, students who could switch between egocentric and exocentric views of the field learned best because each vantage point was superior for invoking certain types of inference.

Several experiments attempting to demonstrate a causal link between general sensory immersion and quality of learning were not successful (Moreno, 2002b; Byrne, 1996; Rose, 1996; Roussou, 1999; Salzman, 1999). In all of these experiments, sensory immersion was not relevant to the subject matter and students could have conducted the same learning activities with a non-immersive display. The best examples of the successful use of immersive VR are the experiments designed and conducted by Salzman (1998) and Dede (1999). In these cases, the learning task specifically required the user's sense of being present in a particular location within the virtual environment (Maxwell World) to best perceive certain facts visible within the

environment. Students learned better in the immersive condition because the immersion was part of the information delivery design.

We may conclude that (1) presence is a necessary but not sufficient, condition for the success of any instructional VR application, and (2) learning outcomes are not predicted by the degree of presence unless it is an explicit part of the VR application's instructional design. However, this raises the question of how learning outcomes can be meaningfully measured.

#### **2.5.4 Information Delivery in VR**

In several papers Winn (1999a, 2001, 2003b) and Furness (1997) praise the expressive powers of the VR paradigm as a useful tool for education. Winn states that VR makes more and better interactions and metaphors possible, such as spatial metaphors for information which provide qualitative insights (Winn, 2001).

Dede (1999) cites several advantages of multi-sensory presentation. Besides being engaging, multi-sensory presentations can provide more ways for the user to interact with the information, rather than just absorbing it passively. Multisensory presentation can be efficient because different sensory channels can be used to present different information, while deliberate redundancy across sensory channels can emphasize or reinforce certain information. However multi-sensory presentations must be designed with care, because different sensory channels have distinct comparative advantages and disadvantages. Particular representations of knowledge may elicit idiosyncratic biases in the listener.

Educational VR supports student interaction with highly complex information and allows the educator to situate learning in meaningful, familiar, motivating contexts, many of which cannot be represented in other media (Winn, 1999b, 2003b; Jackson, 2000). It also allows educators to present complex topics with less need to simplify the subject matter (Furness, 1997). Oversimplifying lessons to fit the teaching method or medium can lead to learner misconceptions, a problem Winn (2003b) calls “Reduction Bias.” Loftin (1993) and Dede (1999) agree with these conclusions but frame them in a more information-theoretical structure.

The theories advanced by Winn found a rigorous test in the work of Mayer (2001) (section 2.5.5, p49) and Moreno (2000, 2002b) (section 2.6.5, p68). Both researchers combine Constructivist and Cognitive approaches. Though Mayer (2001) mainly studied multimedia

designs, Moreno (2000, 2002b) described how the theories they both explore could apply to VR applications. She also studied how using information delivery methods in VR can create successful learning experiences.

### **2.5.5 Mayer's Multimedia Design Principles**

In the late 1980's, Richard E. Mayer developed his "Cognitive Theory of Multimedia Learning" (Mayer 1987) which drew on dual coding theory, cognitive load theory and Constructivist learning theory (Moreno, 2000b). He modeled the process of perception and learning based on contemporary research into such bio-cognitive processes as sensory memory, auditory buffers, short-term memory, and others. His model described the final step to learning the point at which the student combines new information with existing knowledge to construct a new knowledge structure. Moreno used Mayer's theory to shape her inquiries into using information delivery methods in VR to create successful learning experiences.

According to Mayer, multimedia can enrich the learning experience by making better use of auditory and visual channels, which often play only a minor role in contemporary educational strategies. Both sensory channels encode a range of perceptible phenomena, though, as with other sensory channels such as smell, some phenomena convey more specific types of information than others over a given period of time. A simple example is that a color image could be used to convey more information than a monochrome image of the same resolution. This idea can be extended to predict that a CAVE-like display or an HMD with a very wide field of view can provide peripheral visual cues, which can be helpful to the perception of self-motion and self-location as well as the maintenance of a coherent mental image of the environment. Spatialized sound also provides positional information on sound sources and self-location cues. Assuming a skillful design and appropriate use, these capabilities should allow a greater information flow into working memory.

In tandem with better use of specific sensory channels, the VR designer has the opportunity to employ several sensory channels simultaneously. For example, many VR applications for medicine use the sense of touch to provide "haptic" feedback for training surgeons (Westwood, 2004; Satava, 2002). A scalpel or other implement is represented by an

object which is shaped like a stylus. The user grips one end of this device but the other end is attached to a motorized apparatus. While immersed in the VR application, the user can manipulate a virtual object with a virtual tool controlled by this physical stylus. When the virtual tool touches some virtual object, the physical stylus pushes back in the user's physical hand. Depending on the fidelity of the display, the user can feel the shape and even the texture of virtual object. Other applications such as flight simulators employ vestibular input as a sensory channel (Stanney, 2002). Some applications employ smell (Stanney, 2002b) and others employ other senses such as the ability to sense temperature. Again, if the application is appropriate and the design is good, a greater number of sensory channels can be used to allow a greater information flow into working memory.

VR affords the possibility of the use of new paradigms for perceptual integration. Possibly the most often cited new capability of VR applications is to present information in a form which leverages the mechanisms that the user employs to understand the natural world (Wickens, 1995). For example, a building can be presented as a three-dimensional object which the user can explore in an immersive display. By being “inside” the architectural space, the learner does not have to imagine what it would look like to an observer inside the real space. As another example, a process in the natural world, like the progression of global warming, could be depicted in a time-lapsed model of some landscape (Winn 2003b, Jackson, 2000).

Finally, VR can support new paradigms for human-computer interaction. If learning is to be an active process, the learner must also be able to interact with the information efficiently. Along with the rich ways in which VR applications can present information, they also can provide more naturalistic ways for the learner to interact with it. For example, use of a hand-tracking glove (Bowman, 2002) with an appropriate VR application would allow the user to move an object in 3D space by simply reaching out, grasping it and moving the object to where s/he wants it to be. Assuming an effective software and hardware implementation, this is much easier than moving the object with some mouse, joystick or other indirect interface device. Such a more naturalistic mode of interaction would reduce the cognitive load for the user and also would support certain interaction metaphors which would otherwise be prohibitively complex. Ellis (1991) provides an example of this from the training literature, where an astronaut was to learn how to rendezvous with a spinning space capsule. The task is made easier by changing the

user's perceptual orientation so that the capsule is the “ground” and the astronaut is flying “above” it, trying to “land on” it.

These principles may inform the design of educational VR applications and, more importantly, the way in which they are used. However, the success of any instructional technology depends on its ability to satisfy the particular needs of the learner. Some of the characteristics that may contribute to the effectiveness of a VR application are distributed among potential learners in a systematic way.

### **2.5.6 Mayer's (Cognitive) Theory of Multimedia Learning**

According to Mayer (2001c), Learning is an active process, and in practice the curriculum must support the individual student's active inquiry into a problem—a learner centered approach. Mayer built his theory on the following assumptions which have been verified by subsequent research.

- **Multiple Cognitive Channels:** Humans possess separate cognitive channels for processing different types of information, such as textual, visual and auditory information (Mayer, 2001c; Beacham, 2002).
- **Limited Capacity:** Humans can only process a limited amount of information in a particular information channel at the same time.
- **Active Processing:** Humans engage in active learning by attending to relevant incoming information, organizing selected information into coherent mental representations and integrating these mental representations with other knowledge they possess.

This figure shown below is drawn from an article by Mayer (2001c). It illustrates the process he proposes, with most of the boxes representing functional components of the mind and the arrows representing the flow of information.



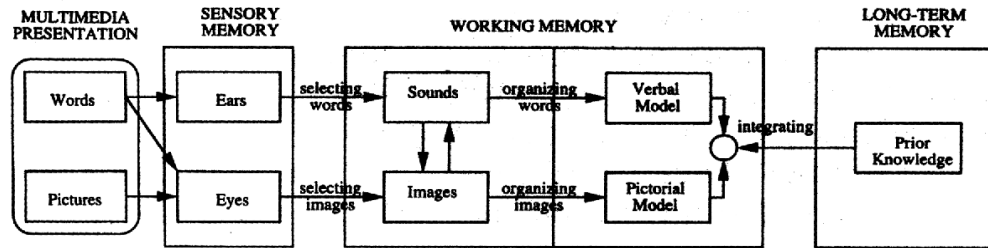

Figure 15. Mayer's Learning Model

It is important to understand that the flow of information is continuous, with higher-level thinking strongly influencing lower level perception and selection. (Barsalou 1992) In other words, the *stepwise processing* occurs at all levels in parallel, as the learner absorbs information. It is *not* a naive “program” by which the learner's mind starts with a lesson at the beginning and end up with a parcel of learning at the end. In the graph above:

- Multimedia presents differing combinations of text and pictures to the user.
- The words and pictures are initially stored in the student's sensory memory, which, for a brief period, records almost everything that s/he perceives. Written words are seen with the eyes and spoken or recorded words are heard with the ears. They are then “understood” through a complicated and subtle process.
- The sounds and images to which the student is receptive move into *working memory* shortly after they are experienced. Working memory is not a “place” where memories reside, but rather is a process which attempts to integrate new memories with the older, more organized, memories. These memories are not organized into discrete categories. For example, sounds may evoke images from memory and images may evoke sounds, as when the student reads written words and “hears” in his or her mind the sound of those words. This process is partially shown by the arrows between the “Sounds” and “Images” boxes in the Working Memory section of the diagram shown above.
- In the next “step,” the words and images are integrated by the processes inherent in working memory that is related to verbal and pictorial model.

- The final step in the process of comprehension is that the student uses both the current the verbal and pictorial input and the structure that has been developed to organize prior knowledge to create new knowledge. This part of Mayer's model represents a process that is much more complex than the prior steps in his explanation.

The limited capacity of the visual and verbal channels that serve as input into "working memory" is very important. Mayer (2001c) cites a series of experiments that show that presenting audio narratives or explanations along with pictures results in better learning than when presenting the same information as text with pictures. This is because written words and pictures compete for the limited capacity of the mind's visual channel into working memory, while the information presented by way of sounds is processed in a different "part" of working memory. If an educational VR application is well designed, a simultaneous presentation of sound and imagery can allow the student to absorb more information more quickly without overloading. Mayer also reports that this effect is stable with animations as well as with static images.

### **2.5.7 Distributed Cognition and Internal Representation**

In the Distributed Cognition model, "trajectories of information" (Hollan 2000) flow through the physical environment, through the minds of the people in them and through the social systems people comprise. The movement and transformation of information in an individual's mind is more commonly known as thinking. The movement and transformation of information in a social system or a culture is often referred to as social discourse, culture, politics, and above all, *teamwork*. Social information is mediated through the use of language and other communication channels. One may use of physical props which have been integrated into the iconography of the culture-for example, certain "evocative" words or images such as the American flag. On a more fundamental level, the physical world encodes information about itself within itself. (Gibson 1979, Norman 1988) The Distributed Cognition approach attempts to build models which bring all of this together into a single theoretical framework within an individual's consciousness and organized memories. This approach borrows heavily from systems theory.

An example of this approach is Hutchins' (1995b) model of an airplane cockpit, which included all of the equipment, the operating procedures and the crew itself. He analyzed it as an

integrated cognitive system, using conceptual models derived from cognitive science and from systems theory. He described how decisions are made and how information is stored, with each component doing its part in the memory (saving state) and problem solving. He treats the crew members as components, thereby creating a detailed account of what is expected of them and of their immediate environment. He speculates that he could very well have included internal models of the pilots' minds, but he felt that level of granularity was not needed for the analysis he wanted to do.

Hollan (2000) argues that the computer and elements of its interface should be perceived as part of the user's active cognitive environment. They should be full participants in distributed cognitive processes, in much the same way that features of Hutchins' (1995b) cockpit could be combined into an integrated cognitive environment.

If cognition is distributed, what does it mean to introduce a student to some task or to a body of information within a particular environment? With the assistance of the educator the learner must adapt to both the environment and to the expected task. Where appropriate, the educator scaffolds the learning process using appropriate explanations, representative learning tasks, and an environment which approximates the target environment as closely as possible. This holds whether the student, himself, regards the learning task as a separate entirety within the cognition/action system (i.e. learning to sing.) or as part of a much larger system. (i.e. learning how to be a member of a bridge crew.) Hutchins (1995a) goes into great deal of detail about how cognition (and therefore learning) takes place in the real world, while Hollan (2000) extends these principles to human-computer interaction.

For educational applications, Distributed Cognition provides a unified way to model the learner, the learning environment and the learning activities. Bell (2000) goes further, stating that a Distributed Cognition approach can be used to understand the material that the students are expected to learn. He gives the example of cultural artifacts which derive their meaning from their original context. That context can be described as representative Distributed Cognitions, and learning activities can be understood to parallel them in a way that encourages the student to learn something about the original artifact. That, in turn, requires the educator to build learning activities which deliberately distribute cognitive activities. Doing so reinforces learning through relevant activities, rather than merely through simple comprehension.

It must be recognized, however, that there is a critical difference between the theory of Distributed Cognition and theories which are based entirely on external models of thought and action. (For example, Ecological Cognition, Activity Theory, Constructionism, and some forms of Situated Cognition) As described above, Distributed Cognition models “trajectories of information,” attempting to understand the possible permutations of specific information as it moves through the cognitive environment, is incorporated into memory, and becomes a factor which guides an individual’s future behavior in and attitudes toward parts of his or her environment. While trajectories can be analyzed at a high enough level of abstraction by treating a person's mind as a black box, more detailed analysis requires modeling the many structures internal to the mind. So, ideas about the nature of the internal structures in the mind are not just compatible with Distributed Cognition but could become a useful components for formulating new educational theories and strategies.

### **2.5.8 Conceptual Change**

“Conceptual change,” which is described below, is not directly related to Immersive VR, but is important to the understanding of many of the educational Immersive VR experiments presented in this study (Dede, 1999; Mohr, 1999; Winn, 2001; Windshitzl, 2000; Jackson, 2000; Johnson, 1999a).

Learning new information and/or skills is an active process, where the student must first make sense of the new information by connecting it to what s/he already knows. The student must resolve conflicts between prior conceptions and the new information, and, finally, s/he must draw new conclusions from his or her new knowledge base (Gagne, 1987; Jackson, 2000). “Conceptual change” refers to a process in which the learner may often have to abandon a prior conception when confronted with both counter-evidence and with an alternative model of the relevant topic. Many of the educational Immersive VR experiments have employed applications for teaching basic science and are specifically geared to create conceptual change, albeit under slightly different names. Grouped by application, these experiments include:

- In the “**Global Change World**” Experiments (Winn, 2001, 2003a, 2003b; Windshitzl, 2000; Jackson, 1999; Jackson, 2000 p10), the authors refer to *paradigm conflict*, a

synonym for *Conceptual Change*. This is where the student begins with an oversimplified or incorrect cognitive model to explain some physical phenomena in the natural world. Confronted with evidence that their paradigm is incorrect, the student often becomes confused and seek out a new explanation. If that explanation is readily available, logically correct, and reinforced by a great deal of scientific scholarship, the users will often listen to it and accept its validity.

- In the “**Science Space**” Experiments, the authors discuss the necessary transformation from students' incorrect conceptions to correct knowledge (Loftin, 1993; Salzman, 1998, 1999; Dede, 1999). Often, new knowledge becomes distorted when the student tries to fit it into a defective schema. This transformational account assumes that old knowledge is transformed through operations. Scholars have produced many theories about why this phenomenon occurs but as yet there is no widely accepted description of this transformational mechanism (Moher, 1999).
- In the “**Round Earth**” experiments (Moher, 1999; Johnson, 1999b), the authors propose a *displacement account* of learning. According to this theory, the learner establishes an alternative cognitive starting point when he or she is presented with information within an artificial environment. The alternative model is established outside of the learner's existing domain knowledge. When the student forms this alternative informational model, it will (hopefully) replace the student's earlier defective model. This conclusion appears very similar to the ideas posited in the *Conceptual Change* theory.

Many authors discuss how difficult it is to change students' misconceptions on scientific topics and how alternative, artificially-generated environments can be used to induce the mental dissonance that can challenge their erroneous beliefs. Preconceived notions can certainly be a problem for the Virtual Heritage applications which are described below, especially those that concern politically sensitive topics. Theories about conceptual change may present productive ways of approaching such problems.

### 2.5.9 Learner Differences

It is generally accepted that some learner differences can be measured in ways that divide students into categories which are useful for instructional design (Mayer, 1987). Common measures are:

1. **Prior Knowledge:** Students are constantly tested, ranked, and grouped according to their measured skills and knowledge, mainly to ascertain what they are ready to learn next (Bloom, 1956).
2. **Motivation:** The student's desire to learn something about a particular topic. This can either exist already, to be created in the student by the instructor curriculum. The instructor must also make sure the student connects that motivation to the required learning activities (Mayer, 1987).
3. **Learning Ability:** This is often measured in standardized achievement tests and IQ tests, which do predict performance in a typical educational setting (Mayer, 1987). However, Gardner (1999) declares that both the IQ/achievement tests and standard curricula are strongly biased toward verbal and mathematical ability. If so, then this correlation is a narrow one and may not hold for more broadly-based learning curricula.
4. **Demographics:** Basic measures such as age, education level, profession, and other standard measures can predict some factors that influence learning,- including levels of prior knowledge, communication preferences, cultural requirements and other social and intellectual forces which shape the learning experience of a particular student. Adaptive media applications can use such factors to impute a user “stereotype”, which can give it a strong start in building its user model (Chin, 1989; Garlatti, 1999; Rich, 1989).

The learner differences described above are addressed in the Immersive VR in education literature. However, there are other important systematic learner differences which it does not address.

Cognitive Aptitudes include spatial, verbal and mathematical abilities, which have a long history in educational testing. If these differences are the results of experience (nurture), then any student can be trained to comprehend any type of information. However, if the differences are innate (nature) then each student will always do better with a curriculum tailored to his or her

abilities. Gardener's controversial theory (1983, 1999) argues that there is no single measure of intelligence, but that each person has some mixture of *seven intelligences*: Linguistic, Logical-Mathematical, body-kinesthetic, spatial, musical, **interpersonal**, and **intrapersonal** skills.

However, it is not always clear how measuring prospective students' cognitive abilities and other aptitudes can be used to develop curricula. Gardner himself criticizes many of his devotees for using his theory to create naive pedagogical formulas (Gardner, 1999). He argues that the most common mistake is to build a comprehensive lesson plan around some single aptitude. For example, one might infer that students with high visual aptitude would benefit most from learning with a highly visual interface. However, students with low visual ability may gain more in such environments (Bricken, 1990) because they can use the incorporated visualizations to reduce their cognitive load. Gardner states that cognitive aptitudes contribute crucially to determining the ways in which a student may learn best, but the two are not the same.

“Learning style” refers to the way a student may best absorb new information. For example, some students may learn more by first investigating the relevant theories about a particular phenomena and then see examples of it in action, while others may prefer to study the examples first and then generalize from them to investigate and validate relevant theories. There is no consensus within the educational community on what the measurable learning styles are or should be, and conclusive evidence has been elusive so far (Mayer 1987).

Nevertheless, several well-known taxonomies (Carver, 1999a; Larkin-Hein, 2001; Danielson, 1997; Chen, 2002) have attracted significant study and there is some empirical evidence which confirms their validity. Again, the question of nature versus nurture is important. If a person's learning style is determined only by a lifetime of experiences, than any student can eventually be trained to learn in any way. However, if learning style is even partially innate, then the student will always benefit more from some educational strategies rather than others Mayer (1987). Cognitive aptitudes are most likely the result of a complex mixture of genetic potentials and learned experience. Learning style is probably a second-order effect based on cognitive aptitudes, aesthetic preferences, acquired learning skills and cumulative knowledge.

Another practical question is: to what extent can a flexible, learner-centered, learner-controlled curriculum address student differences without the intervention of an experienced educator. To some extent, students may be able to satisfy their own needs simply by exercising the options available to them. Perhaps flexible learning environments and supporting curricula

can be designed which divide the task of managing student differences between the student, the instructor and the environment itself.

VR can provide unique learning and teaching tools, which may be especially helpful to learners who are under-served by current methods. Theories of learning style may provide some answers about how to accomplish this. However, most of the educational Immersive VR literature does not seriously address the research in learning styles or cognitive aptitudes, although some scholars, such as Bell (1996) mention that these issues are important. Currently, theories of learning styles vary widely and are controversial in the educational research community. So far, educational VR researchers have not been willing to address the double challenge of experimenting with VR as a teaching tool while targeting the needs of certain learners.

#### **2.5.10 Measurement and Evaluation**

Constructivist theory also has implications for another aspect of educational research, that of measurement and evaluation. Bloom (1956) refers to six levels of learning, as summarized by Clark (1999):

- **Knowledge:** Recalls data.
- **Comprehension:** Understands the meaning, translation, interpolation, and interpretation of instructions and problems. States a problem in one's own words.
- **Application:** Uses a concept in a new situation or unprompted use of an abstraction. Applies what was learned in the classroom to novel situations in the “real world”.
- **Analysis:** Separates material or concepts into components so that its organizational structure may be understood. Distinguishes between facts and inferences.
- **Synthesis:** Builds a structure or pattern from diverse elements. Put parts together to form a whole, with emphasis on creating a new meaning or structure.
- **Evaluation:** Makes judgments about the value of new ideas or materials.



Many educational studies measure learning outcomes with explicit measurements for different levels of learning, often using a taxonomy similar to the one described above though, usually simpler. For example, Land (2000) refers to a level of learning called “transfer,” roughly analogous to Bloom's "Application.” However, few studies actually test for all levels of learning for philosophical or practical reasons. For example, factual knowledge, comprehension, and application (transfer) can be measured with written exams uncontroversially, but Constructivists argue that the higher forms of learning often cannot be tested this way. The student has to design, build and debug very large logical structures, a process which simply takes too long for any timed evaluation in a classroom, and is too interactive to be adequately measured in a written test.

In Constructivism, project evaluation is the primary measurement tool, not only looking at the final product, but at the student’s conduct during the learning process. Many Constructivists go further to say that it is useless to measure learning in anything other than the student's own context. However, this leads to a paradox. For a student to achieve “transfer” s/he has to be able to apply that lesson elsewhere. Furthermore, there has to be some way to evaluate students' knowledge and skills with respect to social standards. Therefore, attempts to both train and test students in “authentic” or ecologically rich environments can lead to too little difference between the training and the test itself. When this happens, only rote learning can be measured clearly. It is acceptable to use the same environment, but test on a different task (transfer) or do the same task in a different environment (Land, 2000). Exploring these issues further is beyond the scope of this study.

### **2.5.11 Winn’s Synthesis**

Dr. William Winn of the University of Washington and his colleagues have produced roughly half of the formal experimental studies in Immersive VR for education (section 2.6.6, p69). His theories began with a mixed Cognitivist and Constructivist approach, rejecting the popular belief that two were incompatible (Winn, 1993). More recently, he developed his own approach, which he calls “Embodiment, Embeddedness and Dynamic Adaptation” (Winn, 2003a) which embraces ideas from Constructivism, Distributed Cognition and cognitive science. In this approach, optimal learning requires:

- **Embeddedness:** in the environment. The mental and physical tasks a person performs cannot be defined without some reference to the environment. This does not imply that the environment *defines* cognition, but that some reference to the environment is required to *describe* cognition.
- **Embodiment:** The learner/actor's physical body is an essential part of the process, because everything we perceive must be mediated through our limited senses. We directly use our bodies to accomplish most tasks and the brain must be regarded as an organ of the body.
- **Dynamic Adaptation:** In a changing environment, we must continually adapt to the changing circumstances. It is also true that the environment changes in response to the person's actions. In this way the individual and his or her environment are evolving together, responding to each other.

While Winn avoids the term *Distributed Cognition*, preferring to say that Cognitive Science has evolved to include issues of context, his theories have significant similarity to those advanced by Hollan (2000) and Hutchins (1995a). Winn's theory is also compatible with what Jonassen describes as a recent consensus between most education theorists, where cognitive and Constructivist principles support unified models of learning (Jonassen, 2000a).

## **2.6 EMPIRICAL STUDIES OF LEARNING WITH IMMERSIVE VR**

Most VR technologies were originally developed for training purposes, most commonly by the military. More recently, Immersive VR has been used as a tool for education in a variety of fields such as mathematics, physical science, geography, architecture, engineering and others. There have been many efforts to use VR to teach declarative knowledge and related cognitive skills, but only a relatively small number of them have been conducted as formal studies (Hay, 2000). Because of this, the educational use of Immersive VR is still not well understood (Salzman, 1999; Winn, 2001). This section will summarize the existing educational studies which have employed Immersive VR, the theories supporting them and areas in which further studies are needed.

### **2.6.1 Introduction**

There are still only a small number of empirical learning experiments with Immersive VR reported in the educational and VR-research literatures (Salzman, 1999; Winn, 2001; Moreno, 2002b; Winn, 2001; Jackson, 2000). Only twelve formal experimental studies are readily apparent in the literature (section 2.6.4, p66). There are probably another fifty informal studies (such as pilot studies, surveys, ethnographic studies and formative evaluations) and approximately four hundred papers reporting those studies and discussing supporting theory, along with reports in the popular press. These numbers are difficult to estimate, first because each discipline which uses VR has only a limited number of educators who are interested in teaching with VR applications. Also, the results of their efforts are usually reported in the literature for that discipline, but not cross-referenced with other studies using educational VR.

Almost all of the experiments reported in this survey were conducted in 1999 or before, apparently for economic reasons. Most of the researchers who conducted the pre-1999 experiments cite a sharp decrease in US-Government funding for educational VR experiments as reason for the lack of recent research (Roussos, 2004; Bowman, 2004; Loftin, 2004; Moher,

2004). The exception is work by Moreno's work (section 2.6.5, p68), Maria Roussou (2006, 2008), and this study.

Fortunately, all kinds of VR applications have become much less costly because of the adoption of technologies developed by the game industry (Lewis, 2002; Dalgarno, 2002a; Young, 2000; Pivec, 2003b; Bruckman, 2002a; DeLeon, 2000; Tougaw, 2003; Stang, 2003; Jacobson, 2002a, 2004a). This may lead to renewed interest, but in the short term it may be a deterrent to further research. Researchers and educators may be reluctant to expend a great deal of time and effort in a technology that they think will soon be obsolete. Another reason may be competition from the online collaborative virtual worlds and other desktop VR applications. These provide significant opportunities for interesting and important educational research at much lower cost than Immersive VR (SecondLife, 2004; There, 2004; Dede, 2004; Andrews, 2002).

An entirely different problem is that VR may still be too poorly defined to support meaningful comparisons between it and traditional teaching methods (Hughes, 2001; Jackson, 2000; Youngblut, 1998). For example, too little is known about collaborative learning in VR to make meaningful comparisons with other computer-mediated or open classroom collaborative activities (Moshell, 2002; Youngblut, 1998). Mayer (2001) goes further to say that direct media-to-media comparisons of all types are rarely meaningful. Not only do different media lend themselves to different teaching methods, but also the method and the medium cannot be separated in any practical approach.

Mayer (2001) recounts the history of new media in education, specifically film, radio, television, computers, and the Internet. Each time a new technology was introduced, there were high hopes that it would transform education. Most of the technologies have found some use in schools, but none have become dominant or even displaced the book. All of these researchers agree that efforts should concentrate first on discovering the educational properties of VR before it can or should be distributed widely or compared to other media.

Nevertheless, many educational Immersive VR studies report successful learning (Byrne, 1996; Winn, 1997c; Osberg, 1997a; Jackson, 2000; Winn, 2001; Dede, 1999; Salzman, 1998). Students in those experiments may have learned the material just as well using some other teaching method, (Winn, 1999b) but the experiments do show that Immersive VR can be used successfully for teaching. As with most other forms of media, it is most likely that Immersive

VR is best used as part of a larger curriculum, rather than a general replacement for other forms of instruction (Bowman, 1999; Wickens, 1992; Hay, 2000).

### **2.6.2 Advantages**

VR allows the user to interact with models of things they could not touch in the real world (Roussos, 1999). Certain places or things may be otherwise inaccessible because of microscopic or macroscopic scale such as molecules, galaxies or weather systems. They may be physically inaccessible, such as the surface of the moon, or inaccessible to students with special needs. They may be no longer extant, such as the Temple of Isis at Pompeii. They may even be imagined or proposed, such as a colony on Mars. They may be dangerous or too expensive to be used in a classroom. They may even be theoretical or abstract (Winn, 2003b; Jackson, 2000; Youngblut, 1998). For example, Global Change World (Winn, 2001, 2003a) allows the learner to manipulate major environmental factors in a model of Puget Sound (Washington, USA) and to travel through virtual time to see the results.

VR can also illustrate subjects and processes that are difficult to express using other media. For example, topics with a strong spatial component, such as architecture, are better expressed in three-dimensional media, rather than two dimensional media such as a blackboard or a printed page. For architecture, Immersive VR has the added advantage of letting the viewer see the inside of a virtual structure. Also, VR is a good way to interface with simulations of dynamic systems. System examples include ocean currents, planetary motion, changes in electrostatic fields, movement of nutrients in a food web and the social behavior in a troop of gorillas. The behavior of such systems is often nonlinear, being an emergent property of an entire system of factors, mutually influencing each other, that change unpredictably over time (Winn, 2003b). Simulations are particularly useful for modeling natural systems.

There is a consensus in the literature that the sense of “presence” afforded by VR-based learning application can enhance learning (section [2.5.3](#), p47). Finally, VR and particularly Immersive VR are popular and tend to be well received by educators and students (Antonietti, 2000).

### 2.6.3 Problems

The interface and control technology for VR is still cumbersome, exhibits poor fidelity and is generally primitive (Dede, 1999), which is a particular problem for educators (Roussos, 1999). Developing effective learning tools with VR requires considerable time, technical expertise and design skills (Winn, 1997). Furthermore, many important applications also require considerable artistic skill, particularly with archaeological reconstructions. Fortunately, advances in mass-market graphics hardware and display technology have greatly driven down the cost of hardware and high-performance graphics software (Lewis, 2002; Dalgarno, 2002a; Young, 2000; Pivec, 2003b; Bruckman, 2002a; DeLeon, 2000; Tougaw, 2003; Stang, 2003; Jacobson, 2002a, 2004a). However, developing for VR applications still requires technical expertise and a considerable artistic effort. Productivity tools for rapid development (Igarashi, 1999; Jung, 2002) tend to improve the quality of the final product rather than reduce the workload of the developer.

There are other, more intrinsic problems as well. Students show wide variation in their ability to deal with the VR interface, which affects their ability to navigate—many students feel lost in the VE (Dede, 1999). Some students never become proficient with navigation in a VE application; usually because they have distance/depth estimation problems (Winn, 2003b). Problems with navigation and control are reported in many of the educational experiments using Immersive VR. Even when a student is able to perform navigation maneuvers comfortably, s/he must still be able to traverse the virtual space without getting lost and without experiencing an excessive cognitive load irrelevant to the learning exercise. Fortunately, VR navigation has been the subject of considerable research and much progress (Darken, 2001). Bowman (2002) developed an excellent taxonomy and set of principles for interaction design in VR applications.

However the act of navigation itself may result in motion sickness caused by the sensory conflict in immersive displays—a well documented problem (Harris 1998, 1999; Kennedy, 1992, 1995; Kolanski, 1995; Lin, 2002; Prothero, 1999; Kuno, 1999; Owen, 1998; Howarth, 1998). Most educational experiments using Immersive VR report that some test subjects had significant problems with motion sickness induced by the display (Jackson, 2000). Also, the long-term side effects of exposure to Immersive VR, if any, are not known (Winn, 2003b). It is interesting that large audiences regularly attend immersive dome displays (e.g. an Omnimax theater) and

audience members often experience motion sickness. To my knowledge, however, there has been no public outcry about the dangers, the attractions remain popular and no special safety protocols have been enacted.

Finally, the degree to which VR is engaging, just because it is novel and perhaps fashionable, could confound experimental results. This would be a kind of Hawthorne Effect (Campbell, 1963), which could probably be mitigated by giving students enough time to get used to VR. It should not interfere with learning experiments which compare different VR conditions, as long as students' enthusiasm does not lead to a ceiling effect.

#### **2.6.4 Summary of Previous Experiments**

Table 1, below, lists the previous educational experiments by theoretical approach, quality of design and nominal success.

In a constructionist learning experiment, the students learn something by building a virtual environment or part of one. In an experiencing experiment, students interact with some ready-made VE. Note that a constructionist learning task is always Constructivist, while an experiencing task may or may not be part of a Constructivist learning experience.

A study will be marked as strong if the experimental design is sound and complete and the implementation is sufficient. A study is labeled as weak if it was intended to be an experimental inquiry, but there is a significant flaw either in the experimental design or in the implementation. Sometimes, however, an experiment can have a major flaw in its design, but still produce a believable result. Usually this occurs when secondary measures or other circumstances support the conclusion.

A study is classified as Successful if it proved its hypothesis or produced some closely related discovery, otherwise, it is marked as Inconclusive. Some of the best designed and implemented studies fail, especially in educational testing, which has many inherent difficulties. Nevertheless, inconclusive studies may produce much useful material.

Finally, the dominant display device used in the VR application in each study will be listed. A CAVE is an enclosure made of rear projection screens, which surround the user with a stereoscopic view of a computer generated landscape (Cruz-Neira, 1993). An HMD is a device worn on the head, which drives two small displays, each one directly in front of one of the

viewer's eyes, to produce the experience of total visual immersion in the virtual environment. A deliberately introduced difference between the left and right eye views creates a stereoscopic effect enhancing the illusion of depth. "Desktop" refers to a basic computer monitor, keyboard, and mouse.

**Table 1.** Previous Experiments with Immersive VR

Reference	Section	Quality	Success	Experiencing / Constructionist	Interface(s)
(Moreno, 2002a)	2.6.5	Strong	Successful	Constructionist	HMD vs Desktop
(Winn, 2001)	2.6.6.2	Weak	Successful	Experiencing	HMD
(Jackson, 2000)	2.6.6.4	Strong	Inconclusive	Experiencing	HMD
(Bowman, 1999)	0	Weak	Inconclusive	Experiencing	HMD
(Dede, 1999)	2.6.7.2	Strong	Successful	Experiencing	HMD vs Desktop
(Roussos, 1999)	2.6.8	Weak	Inconclusive	Constructionist	CAVE
(Salzman, 1999)	2.6.7.3	Weak	Inconclusive	Experiencing	HMD
(Salzman 1998)	2.6.7.1	Strong	Successful	Experiencing	HMD
(Osberg, 1997a)	2.6.6.3	Strong	Successful	Both	HMD
(Winn, 1997)	0	Strong	Successful	Both	HMD
(Byrne, 1996)	2.6.6.5	Strong	Successful	Experiencing	HMD vs Desktop
(Rose, 1996)	2.6.6.6	Weak	Inconclusive	Experiencing	HMD

Only formal experimental designs have been listed, those which use a classic experimental design or a quasi-experimental design, when laboratory conditions are not practical (Campbell, 1963). I do not wish to imply that non-experimental studies are valueless. They include usability studies, focus groups, formative evaluations, ethnomethodological studies and other forms of structured inquiry. These methods can resolve obvious problems quickly, refine the application, refine testing methods, generate testable hypotheses, gather anecdotal information and examine problems where formal methods are not usable. A good example is a study by Roussos (2006, 2008) which uses Activity Theory to analyze student activity during an



ImmersiveVR experiment. Non-experimental studies are not a direct concern of this review, although some will be referenced.

None of the experimental studies listed in Table 1 contained any significant pre-experiment analysis of the physical controllers used and how they might affect user interaction and the experiment. Many of them suffered significant problems with user navigation, sometimes so severe that they cause the failure of the experiment (Jackson 2000). More attention to interface design is needed. For example, Bowman (1999, 2002) describes a task and design strategy for VR interaction design which is quite helpful for interaction design and analysis.

### **2.6.5 Moreno's Research**

Moreno (2002c) and Mayer examined the learning effects of sensory immersion using VR and whether certain design principles from multimedia apply to VR-based learning environments. The results of two formal studies reported in Moreno (2002c) are summarized below.

Learning activities and materials for both experiments were based on the learning game, "Design-A-Plant." In the game, the student is given series of alien worlds with known environmental conditions, and the student has to design plants which can survive in those environments. S/he is assisted by a pedagogic agent who gives personalized advice, feedback and encouragement.

The first experiment has a two-factor design, with three levels for each factor. The first factor is immersion, where the student uses either Desktop VR while remaining seated or wore an HMD and able to walk around. The second factor is the delivery method of the pedagogical agent's narrative—either text, or audio or both. The working hypothesis of the experiment appears to have been that (1) greater immersion produces a greater sense of presence (2) immersion affects learning and (3) delivery method of the narrative affects learning. Results showed that students did have a greater sense of presence with greater immersion and learned more when the narrative was delivered in an auditory form. No learning effect for degree of immersion was found, nor was any interaction effect found.

The second study had the same protocols as the first, except that the walking-and-HMD condition was eliminated. The other major difference is that the third *a priori* hypothesis is different: that students learn more deeply if the narrative is delivered as both text and audio. The

results of the second experiment agree with the first in that the students reported that greater presence with greater immersion and that the degree of immersion had no effect on learning. They also found that auditory narrative was the best method of delivering the material. Students with both narrative and text learned no better than students with narrative alone and, students in the text-only condition did considerably worse than student who received only narrative. No interaction effects were reported.

### **2.6.6 Research at the University of Washington**

The mission of the HIT Lab at the University of Washington is to use VR as a tool for the advancement of education. Dr. William Winn and his students have led most of the empirical studies (Winn 1997, 2001, 2002; Jackson, 2000; Osberg 1997a) which are based in the Department of Education at the same university. Studies based in other departments were conducted by Bryne (1993, 1996), a student of Tom Furness and Merideth Bricken, and Rose (1996) a student of Furness and Winn. Also, Dr. Winn has written extensively on educational theories relevant to the use of Virtual Reality for education. (Winn, 1993, 2002, 2003) Given the difficulty of empirical educational testing in general, and with new technologies in particular, this group did well. Of the empirical studies listed,

1. Two were strong and successful (Winn, 1997; Osberg, 1997a).
2. Two were weak but successful anyway (Winn, 2001; Byrne, 1996).
3. One had a strong design but was inconclusive (Jackson, 2000).
4. One was weak and inconclusive (Rose, 1996).

This group's research efforts are not well reported or referenced in the mainstream Immersive VR literature in journals such as *Presence, Cyberpsychology and Behavior* and at conferences such as *Virtual Reality, SIGGRAPH, and Medicine Meets Virtual Reality*. This probably because Dr. Winn's publications appear in the educational literature, which receives only limited attention from the mainstream VR researchers who are mostly computer scientists. Papers reporting experiments by Dr. Winn and his group take a primarily Constructivist approach, but they also reference the concepts and literature from cognitive science (Jackson 2000, Winn 1997, Winn

2001). In an early paper, Winn (1993) argues that Constructivism and cognitive science are compatible. Ten years later (Winn 2003b) described his unified approach. Experiments performed by this group are summarized here by the papers in which they were reported.

**2.6.6.1 The Effect of Student Construction Of Virtual Environments on the Performance of High and Low Ability Students (Winn, 1997):** Elementary students worked in small groups, to produce a small Virtual Environment intended to help the user learn about certain topic materials specified by the teacher. Each student helped to build one educational VE then experienced one produced by a different group. All students received a pretest and a posttest for the subject matter for both virtual environments s/he had contact with. Results were analyzed with a two-way ANOVA, where the first factor was whether the student had constructed the environment or experienced it. The second factor was the student's "ability" as measured by the Raven Progressive Squares test (CPS, 2004). The main hypothesis was that higher ability will lead to better learning performance, and that constructing the VE will produce better learning than experiencing it.

No main effects were found, but there was a strong interaction effect: students with high Raven scores did well regardless of constructing or experiencing the VE, but students with low raven scores did much better in the constructionist condition ( $p < 0.01$ ). The experimenters concluded the students with low ability were aided more by the constructing experience. An alternative explanation is that the students with low Raven scores were simply an under-served population in the school system, whose intelligence is not evidenced well in written tests and who learn better by doing rather than experiencing. The experiment was successful because it revealed the interaction effect.

**2.6.6.2 Learning Science in an Immersive Virtual Environment (Winn, 2001):** Students were immersed in a virtual environment, which visualized the action of the tides, current flows and salinity levels in a simulation of Puget Sound in Washington State, USA. They were able to investigate the dynamics of that system by "flying" through the simulation, adjusting the time scale and introducing certain changes to the environment to observe the result. Students received a pretest of the topic materials, participated in learning exercises, and then completed a Post Test. The hypothesis was that students would learn from the experience, and pretest-Post Test

comparisons implied this, however there was no Control Group, making the study weak. Nevertheless, they did record a positive result-students did learn from the simulation.

**2.6.6.3 Constructivism in Practice: The Case for Meaning-Making in the Virtual World (Osberg, 1997a)** Students produced a small Virtual Environment (VE) which illustrates a natural cycle (water, carbon, nitrogen or energy). Each student helped to build one educational VE then experienced one produced by a different group. All students received a pretest and a Post Test for the topic materials for both virtual environments s/he had contact with. Pretest-Post Test learning differences were compared between: (1) materials learned by constructing a VE, (2) materials learned by experiencing a VE, (3) traditional instruction, and (4) no instruction. The constructionist learning group learned significantly more than the no-instruction Control Group, but there were no other significant differences found between the groups. Her study failed to prove its main hypothesis, but did demonstrate successful learning during the constructionist activities.

**2.6.6.4 Collaboration and Learning Within Tele-Immersive Virtual Environments (Jackson, 2000)** Students learned about global climate change using Global Change World, an immersive simulation of weather and climate conditions in the Puget Sound area. Students change (virtual) factors such as CO<sub>2</sub> level, rainfall, and vegetation and observe the effects of (simulated) global warming. There were three treatment groups: (1) students working alone, (2) students working in collaborative pairs, “seeing” each other in the virtual environment, and (3) students receiving significant guidance from the instructor. The central hypothesis was that students would learn better with either type of collaboration. Because of significant testing problems, Jackson judged the data to be too unstable to produce any conclusive results.

**2.6.6.5 Water on Tap: The Use of Virtual Reality as an Educational Tool (Byrne, 1996)** Students used Virtual Chemistry World (VCW) to build molecules from atoms. There were two primary factors in the experimental design: immersion versus interactivity. The high-immersion, high-interactivity condition was the VR version of VCW. The low-immersion, low-interactivity condition was a two-dimensional version of VCW. The low interaction, low immersion condition was a video. There was no high-immersion, low-interactivity condition. The main hypothesis

was that both immersion and interaction would improve learning. No significant learning difference was shown between students who used the immersive VCW versus those who used the two-dimensional version. This is probably because the VE in the immersive condition conveyed no more information than the one in the two-dimensional condition and did not have any better interaction options. However, students in both interactive conditions learned better than those in the non-interactive (video) condition.

**2.6.6.6 Design And Construction Of A Virtual Environment For Japanese Language Instruction (Rose, 1996)** This study compared students' success at learning how to construct Japanese prepositions using (1) standard text-only learning exercises, (2) learning exercises which include moving physical props to illustrate the meaning of each proposition, and (3) learning exercises similar to those in the second condition, conducted in an immersive virtual environment. The main hypothesis was that learning outcomes for students in the second and third groups would be similar and that both would be superior to those for treatment one. Results were inconclusive, with no significant differences in learning between any of the groups. This was attributed to an insufficient number of test subjects. This experiment attempted to compare learning across different media and different teaching methods, which is very difficult (Mayer, 2001; Moreno, 2002b).

## **2.6.7 The Science Space Experiments**

“Science Space” is a set of immersive educational projects produced by Chris Dede at George Mason University R. Bowen Loftin at the University of Houston, and Dede's doctoral student, Marilyn C. Salzman (Dede, 1996). They conducted at least two formative evaluations of ScienceSpace applications, one survey and three formal experiments. Of those experiments,

1. One was both strong and successful (Salzman, 1998).
2. One had a weak design, but was successful anyway (Dede, 1999).
3. One was weak and inconclusive (Salzman, 1999).

**2.6.7.1 Using VR's Frames of Reference in Mastering Abstract Information (Salzman, 1998)** This study used Maxwell World, which places the student in a VE featuring a visible model of a hypothetical magnetic field. The student can manipulate the shape of the model by moving a (virtual) magnetic charge in or near the field. The method of viewing can be (1) exocentric, where the user sees the entire field and the charge appears as a movable object, (2) egocentric, where the user's view is co-located with the charge, as though s/he were the charge itself, (3) both, where the student can switch from an egocentric to an exocentric view at will. The hypothesis was that the exocentric and egocentric views would each provide unique advantages for learning different aspects of magnetic fields, and that having both modes available would be best of all.

Results from the egocentric-only and the exocentric-only groups indicated strengths in the expected (different) areas of the knowledge Post Test, but the results were not conclusive. Students able to switch between both viewing modes produced the best learning results. This experiment was strong and successful, because (1) it used Immersive VR for its particular strengths, (2) it asked an important and useful question, (3) the experimental design was sound, (4) previous formative evaluations had improved the design and stability of Maxwell World, and (5) the subject matter was compatible with the low-resolution graphics available to the experimenters.

**2.6.7.2 Multisensory Immersion as a Modeling Environment for Learning Complex Scientific Concepts (Dede, 1999):** Students in one group used EM Field, a respected learning application which uses two dimensional representations of electromagnetic fields. Students in the other group used Maxwell World, which was restricted to provide the student with only an exocentric view of a three-dimensional model of an electromagnetic field. In both applications, the student learned about magnetic fields by moving a virtual magnetic charge in or near the field. The hypothesis was that students in the VR condition would give better answers to certain questions which require an understanding of the spatial aspects of the material, which is what the experimenters found, at ( $p < 0.05$ ). If this experiment had been conducted in isolation, I would classify it as “weak,” because the number of test subjects (fourteen) was small for an educational experiment. However, the context of Salzman's (1998) study and the large number of formative studies conducted by this group (at least three are reported) make the results convincing.

**2.6.7.3 A Model for Understanding How Virtual Reality Aids Complex Conceptual Learning (Salzman, 1999):** The experiment used Newton World, an Immersive VR application for teaching kinematics and dynamics. The student throws a ball against a wall, where the student can change the properties of the environment such as friction and the elasticity of the ball. Potential energy, kinetic energy, and other information are visualized through use of color, object size and so on. There were three treatment groups with varying degrees of sensory immersion: (1) Visual only. (2) Visual and auditory. The user can hear the ball bouncing. (3) Visual, Auditory and Tactile. The user can feel the ball. The hypothesis was that the greater the degree of sensory immersion, the better students' learning outcomes would be. No significant differences were found.

## **2.6.8 The NICE Projects**

Research in collaborative learning with children in Immersive VR was conducted at the Electronic Visualization Laboratory at the University of Chicago (Johnson, 1998a, 1998b, 2002, 2003; Roussos, 1997a, 1997b, 1999; Moher, 1999). The core of the group is Dr. Moher and his

two students, Johnson and Roussos. Their studies used HMDs, but this group used the CAVE which they networked to a big-wall workstation and the Web. At the time that the studies were conducted, the technology used was the most advanced, and their experiments were the most ambitious in combining many different factors in their learning experiments. They produced two pilot studies and one weak experimental study (Roussos, 1999) which were all inconclusive, and which showed only anecdotal evidence of learning.

### **2.6.9 The Virtual Gorilla Exhibit**

A set of Immersive VRED experiments was centered on the Virtual Gorilla exhibit at the Atlanta Zoo. The first effort was a formative evaluation (Allison, 1997) followed by one weak and inconclusive experiment (Bowman, 1999). Later, Hay (2000) conducted a constructionist learning programme, an ethnographic study, based on the virtual gorilla application.



## 2.7 VIRTUAL HERITAGE

Virtual heritage (VH) is the use of electronic media to recreate, or interpret, culture and cultural artifacts as they are today or as they might have been in the past (Moltenbrey, 2001; Roehl, 1997). By definition, VH applications employ some kind of three-dimensional representation and the means used to display it range from still photos to Immersive VR. We are interested in the VH applications which are also VR applications. This section will detail the history of VH, and advantages and problems specific to educational VH applications, with particular emphasis on pedagogic agents and educational Immersive VR. General issues around adaptive pedagogic agents are explained in section 2.7.5, p85, and the use of Immersive VR for educational experiments is explained in section 2.5, p41. Techniques for implementing VH applications are described here.

### 2.7.1 History of VH

Humans have always described their perceived cultural past with whatever communication media that are available. These have included single dimension narrative texts, two-dimensional paintings and drawings, three-dimensional models and four-dimensional reenactments (height, width, depth, time). Since antiquity, many cultures have used statuary of the dead, ritual enactments of legends and history, and physical scale-models to represent people, places and events. Since the 18th century, museums and private collections have used dioramas, scale models depicting (for example) people from the past or distant cultures engaged in daily activities.



**Figure 16.** The Cyclorama at Gettysburg, USA

The late 17th century saw the development of the cyclorama, a “large composite picture placed on the interior walls of a cylindrical room so as to appear in natural perspective to a spectator standing in the center of the room” (Houghton-Mifflin, 2000). Cycloramas were especially popular in the 19th century, and some are still in use today (Maloney, 1997). Also in the late 19th and early 20th centuries, physical VR-like attractions used props and actors to create an otherworldly experience for visitors. In one such installation, visitors boarded a mock rocket-ship and “flew” to the moon. They then walked through a series of artificial caverns staffed with costumed actors, all contrived to represent a fanciful lunar civilization (Maloney, 1997).

Today, “living museums” recreate historic sites complete with actors who reenact daily life and important events. For example, Fort Snelling in Minnesota, USA, is an actual Civil-War fort, now staffed by actors who interact with tourists. This tradition continues in most forms of electronic media, with film documentaries often presenting historical dramas and multimedia

applications presenting animations and images depicting historical facts. Since the 1980's, mainframe computers, capable of advanced graphics, have been used to build detailed virtual models of existing and reconstructed artifacts (Jacobson, 2004c; Capasso 2004). Today, many Virtual Heritage applications use a desktop VR interface, while very few use Immersive VR.

### **2.7.2 Advantages**

By definition, Virtual Heritage applications always feature a three-dimensional model of some cultural artifact or architectural space. These models, and the process of making them, have several advantages for both researchers and educators.

For the researcher, high-quality 3D renderings of existing artifacts can make them accessible to a wider audience while preserving the often fragile originals. (e.g. A Neolithic cave painting.) Three-dimensional renderings are also an efficient tool for collaborative work, because archaeologists around the world can share them easily. If the artifact itself no longer exists, the act of reconstructing it forces the archaeologist to confront gaps in the evidence and contradictions or weaknesses in existing theories (Frischer, 2003; Levy, 2004; Champion, 2001). The value of 3D modeling is so well recognized, that architects have been constructing 3D models of planned buildings since ancient times, and CAD software is now a required tool for most architectural projects.

For educators, a spatial model can be an efficient means of communicating a large amount of visual information. One detailed 3D model can contain as much visual information as a large number of still images, and it leverages the user's natural spatial perception abilities. This is especially important with architectural spaces that are “well-integrated” in the sense that information is encoded in the way the space looks to an observer. An Egyptian Temple is an extreme example of this, because the hieroglyphics, the larger painted images, and the conduct of ceremonies are all tightly integrated, with the physical space itself being the main semantic organizing principle. Such an artifact is best viewed with the space intact, from the vantage points from which it was meant to be seen. In addition, users find 3D renderings compelling, and a good rendering of a beautiful monument is also beautiful. This helps users accept the technology and engage in the experience. If a 3D model appears to beautiful, it is likely to

possess an added degree of perceptual coherence, which in turn can make it a more effective vehicle for information.

Most VH applications present the user with an unchanging landscape to navigate or a static object to examine. As important and useful as this is, VR technology supports many more options than simply modeling.

1. Autonomous agents can represent ancient peoples conducting their business or interacting with the user (Economou, 2001; Ulicny, 2002).
2. The VR interface can engage the other senses, using sound, touch, proprioception (sense of balance), and even smell. By engaging the other senses, they can convey more information, provide a more complete simulation, and create a stronger sense of realism (of the object) or presence (of the user in the virtual space). Examples include a virtual statue of a bull which the user can “touch,” (Nord, 2003) and a virtual mosque complete with virtual actors filling the space with liturgical song (Karabiber, 2002). The “acoustical heritage” of cultures is important and usually overlooked in VH applications.
3. Networked multiuser environments (ActiveWorlds 2004) allow distant students and educators to “meet” in a shared virtual environment, which can be constructed for Virtual Heritage (Raalte, 2003; Santos, 2002).
4. Interaction and activity dominate engagement and are central to learning (p33). Goal-seeking activities are especially effective, and can be cast in the form of a game (Champion, 2004; DeLeon, 2000).

As VR technology becomes more widely available, it will be employed in Virtual Heritage applications in novel ways. Nevertheless, all VH applications depend on good interaction design and sufficient artistic quality.

### 2.7.3 Problems

An archaeological reconstruction is necessarily pieced together from existing evidence which is often incomplete and which requires many judgments during construction. Depending on the level of conjecture tolerated by the reconstruction project, the builders may produce a reconstruction based on one of several competing theories of what the artifact really looked like. However, the final appearance of a static model is emphatic in the way it presents the model as the way the artifact must have looked. Uninformed viewers are likely to accept the model as authoritative (Champion, 2004a; Frischer, 2003). A static visual solution, like coding features with colors or with opacity would seriously degrade the appearance and the effectiveness of the model. Temporal solutions, like toggling certain features on and off, are probably best, but they complicate interaction design and are more difficult to implement.

Another problem is that archaeological evidence of any site reflects its entire history, not some snapshot in time. For example, ancient monuments with a long history may have features from more than one time period. Deciding what to put into the virtual reconstruction requires considerable judgment and sensitivity from the authors. The Venice Charter (VeniceCharter, 2004) on physical restorations and reconstructions recommends that all time periods represented in an artifact should be respected. Guidelines from the Charter and agreements like it can be helpful to VH designers.

Determining historically accurate simulations of ancient peoples and their activities is especially difficult (Weis, 2004). Most of the evidence of how they looked and what they did is indirect, inferred mostly from ancient artwork, writings, and funerary arrangements. Nevertheless, this work is important, because the ultimate goal of archeology is to infer what ancient cultures were like by examining their artifacts.

Unfortunately, Virtual Heritage is widely abused to produce misleading reconstructions of archaeological treasures, usually for entertainment purposes (Moltenbrey, 2001). While there is nothing wrong with “borrowing” material from the real world for works of fiction, many fictional recreations of the past mislead the audience for no purpose. For example, the 2001 film, “The Mummy Returns,” shows a scene in ancient Egypt where two women are sparring with Korean weapons (Sai) that won't be invented for millennia. One way to reduce the problem may

be for genuine archeology to become more accessible to the public. VR may be a good medium for doing this, just as television has been through documentary programming (AIA, 2004).

Finally, low resolution virtual models have been inexpensive and relatively easy to construct ever since the early 1990's, when VRML became popular. Low-cost game related technologies are now driving software and hardware costs down even more. However, high-quality imagery and interactivity still require significant time and expertise to produce, primarily because of the demands of the artwork.

#### **2.7.4 Building a VH Environment**

This section describes some of the methods used for building three-dimensional models, especially architectural models, since they are ubiquitous in VH applications.

The first decision that must be made is whether the VH objects should be automatically generated or constructed "by hand." A branch of scientific visualization employs visual recognition algorithms to build 3D models of buildings and objects using photographs or direct sensor scans of the object's surface (Moltenbrey, 2001; Han, 2000; Kanade, 1997). For example, Duran (2004) used GIS data to auto-generate a simplified model of the historical section of Istanbul, which his team is "filling in" with more detailed hand-built models. Other applications take 3D scans of museum artifacts and make them available on the web (Zheng, 2000). Still others feature highly detailed models of existing monuments (Ledermann, 2003). Human faces can be reconstructed using volumetric data (Attardi, 1999; Spice, 2004). The models are generated automatically and embody a very high level of detail.

This approach is superior for many applications, especially those requiring virtual simulations of physical objects. However, the models produced tend to have a high internal complexity, using unnecessarily complex geometry to produce the visual model. This makes the models difficult to change, as must often be done when the object is to be placed in some context, when the virtual object is used as a starting point for a model of the artifact restored to some earlier appearance, or when the model is intended for use in some larger model, composited from scanned components. Building a larger composite model from scanned components requires modifying (usually trimming) the machine-generated scans of its parts, which requires some

effort and judgment. Finally, the overly-complex models use a larger portion of the computer's rendering capacity than models which are constructed "by hand."

Figure 17 illustrates the advantages of hand-made models for relatively simple objects. It contains two versions of a decorative block of masonry. The model made with 34000 triangles (on the left) was produced by a highly-accurate 3D scan. The model on the right contains 21 triangles and is mostly in the image maps applied to a hand-made 3D model. The image maps were probably made from photographs of the original block. In most modern graphics cards for PCs, performance is determined by the total number of triangles in the virtual scene. Texture maps also require memory, but as long as the total amount of dedicated texture memory on the graphics card is not exceeded, the effect on performance is usually much less than the savings gained from using fewer polygons.

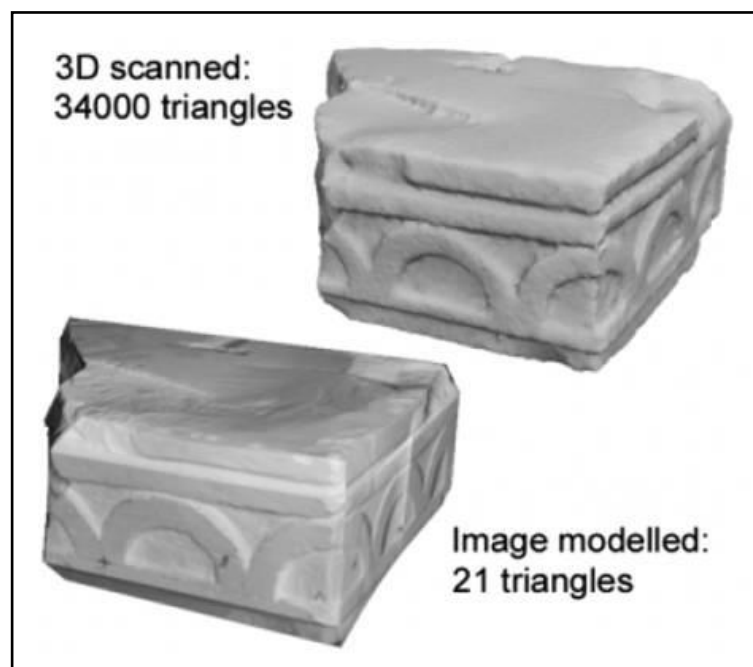

**Figure 17.** Example of shape vs. texture to produce detail (Papiaoannou 2003).

Once the designer has decided whether to generate the material automatically or manually (or some combination of the two), a long, complex process is required to produce the virtual objects or environment. Using archaeological evidence, VE designers can create models and simulations of lost or damaged architecture, artifacts and peoples. As an example, we will look at the manual reconstruction of an architectural space.

The first step is to recreate a geometric model, usually based on drawings and photographs of ancient ruins, depictions and descriptions of the space (if any) in ancient artwork and reconstructions (usually drawings or paintings) produced by earlier scholars. Once the model is in place, digital “textures” are applied to it. A texture is usually a modified photograph showing the surface of an object or a material. Textures range in complexity from a simple material (e.g. stone) to complex artwork (e.g. a fresco or mural). The artist then applies the textures to the geometric forms, in software, one at a time by “mapping” each texture onto a portion of the model. For example, an image of a human face may be mapped onto mannequin-like head shape to create a 3D virtual statue. Finally, the artist specifies light sources, such as a (virtual) sun or fires or candles.

The reconstruction process is time consuming and meticulous, and the artist's skill makes a significant difference in the quality of the final result. The artist and the archaeologist/historian work together closely, rebuilding the artifact or space by stages. Often the archaeologist will have to make changes to the reconstruction plan as the process itself leads to new insights (Frischer, 2003; Levey, 2004). The degree of effort is greatly influenced by how much of the architecture must be reconstructed from indirect evidence. For example, the Temple of Isis in the Pompeii project (Jacobson, 2004c) had to have all of its walls in place and properly decorated. However, the artworks in the upper portions of the temple are completely missing, so it had to be replaced in with wall-art from other monuments. To leave the walls blank would have made the reconstruction's overall appearance highly inaccurate.

Creating “virtual people” (agents) is a far more complex process, one that only few VH applications have attempted (Economou, 2001; Ulicny, 2002; Jacobson, 2005c; Champion, 2004a; Raalte, 2003; Santos, 2002; Karabiber, 2002). High-quality models of virtual humans must be sculpted using advanced animation tools, with joints fully specified. Then, their individual motions (e.g. flex an elbow, bend at knee) and more complex motions (e.g. walk, run, sit) must either be individually crafted by the artist or driven by advanced software. For simpler animations, usually based on VRML, the behavior of the human figures can be programmed directly, but high quality movement cannot be achieved without very great expense.

The most popular tools for advanced modeling and animation are applications like Maya and 3D Studio Maxx. Mid-level tools include UnrealEd (EpicGames, 2004) and Lightwave. There are also many tools for VRML modeling and animation which allow authors to create



Virtual Heritage applications and to integrate them with web-based applications inexpensively. Newer VRML editors support rapid 3D design with sketching tools (Igarashi, 1999; Jung, 2002). VRML does not support high levels of visual detail and provides only minimal support for animation. However, VRML is free and open source, has a very large user community (Web3D, 2004), is simple to program and integrates well with web-based applications.

Finally, spatialized audio can be a compelling addition to a virtual space (Karabiber, 2002) and there is an entire industry which provides software and hardware for it. Even simple sounds which activate and deactivate when the user comes near to some trigger location can be crafted to make the virtual environment much more believable.

### 2.7.5 Lifelike Pedagogical Agents

For educational multimedia and VR applications, a pedagogical agent is commonly defined as an application which pro-actively supports learning. The agent operates within or as part of a larger application and functions as an actor who supports the application's instructional design. The agent may interact explicitly with the student or may act quietly in the background as with many adaptive hypermedia applications (section 2.4, p32). An overt agent may communicate with the user via pre-recorded text or audio segments, generated text or speech and/or presented imagery (Chittaro, 2003, 2004). Agents may also be embodied with a visual representation, usually an icon, a face, or a complete body. Additionally, visible agents may use facial expressions and body language to convey information.

Lifelike embodied pedagogical agents can help educational software provide active support for the learner (Kim M, 2003; Moreno, 2000a). They may be particularly useful in Virtual Heritage applications, because agents can be fully integrated into the virtual space and into the subject matter itself. Furthermore, the agents can be programmed to interact with the student and to adjust to the user's level of knowledge and to the persona that the user assumes within the application. Generally, this approach helps the student feel embedded and embodied in the virtual environment (section 2.5.11, p60). It also supports a more believable and functional social interaction between the software and the student, which in turn constructively (or do you meant Constructivist? If not, used "effectively, since "Constructivist" and "constructively" are very similar) supports learning.

There has been little research featuring lifelike agents in Virtual Heritage applications and apparently only one with a pedagogical agent (Economou, 2001) although agents are likely to have the same benefits as with other educational media applications. This section will briefly summarize the history, background, advantages and challenges of conducting educational research with pedagogical agents.

In the 1970's, researchers experimented with intelligent tutoring systems (ITS), which are educational software packages that use AI techniques to guide the student through a learning curriculum (Boulay, 2001). At minimum, these applications would guide the student through a specific subject area using a set of interaction rules driving program behavior. Later, researchers

recognized the limitations of the automated tutoring systems of the time, so they developed more varied roles for programmed instructional intelligence. Today, the ITS databases contain large amounts of subject matter and the interaction rules have become very complex as well. This is especially true since recent advances in natural language processing (NLP) have made human-computer interaction increasingly naturalistic. The more advanced systems continually model the student and respond according to the student's needs in light of the current learning goals. The general trend is toward helping the student to act independently and to have more control over his or her learning experience while at the same time supporting social and cooperative learning (Cho, 2003; Dalgarno, 2001a, 2002b; Boulay, 2001; Hongpaisanwiwat, 2002).

Many desktop-VR applications employ agents. Some pedagogical agents are used for educational experiments in MUDs and MOOs, (Bruckman, 2002b; Dede, 2004) while others are used in stand-alone applications (Chittaro 2003, 2004; Megazina, 2002; Jiman, 2002). However, no Virtual Heritage application has yet implemented a lifelike pedagogical agent. Though many Virtual Heritage applications have simulated ancient peoples with programmed humanoid agents (Gauthier, 2003; Jacobson, 2005c; ACID, 2004; Karabiber, 2002; Ulicny, 2002), few of these agents are intelligent and none are programmed to guide the user through a learning process. The only Virtual Heritage application I know of which uses any kind of pedagogical agent is SENET which employs a desktop VR style window surrounded by a frame. The agent is in the frame (Economou, 2001). Finally, I am not aware of any educational experiments with Immersive VR which have employed a pedagogical agent.

The technology for building lifelike pedagogical agents in Immersive VR is now available and more research in this area is needed.

A lifelike agent can convey a great deal of information through its facial expressions, body language and motion, all of which can leverage on the agent's narrative and the context provided by the virtual environment. Most importantly, a lifelike agent can employ the rich semantics of gesture and expression which support verbal communication. For example, the sentence, "He put *that* over *there*." is only intelligible in a visual context where the speaker points to an object (*that*) and some location (*there*). Having an agent convey information employs dedicated capacity in the human sensorium, which supports rapid recognition of emotional states, social cues and language.

Studies show that users regard these social interactions as real and (mentally) work hard to benefit from them (Picard, 2000; Hongpaisanwiwat, 2002). The appearance and behavior of a pedagogical agent has an important effect on whether the student likes or dislikes the learning experience and how s/he values the learning application. Recent research on affective computing (Picard, 2000) has shown that people treat computers as social actors and judge the computer's performance as such. All other factors being equal, an agent which is crafted to interact agreeably with the user should gain user acceptance and cooperation in learning tasks (Fong, 2003).

Constructivist learning theory holds that the student learns best in an interactive environment where s/he has significant influence on the learning experience. The best learning interaction, according to Constructivists, is social interaction where the student receives help from instructors and fellow students and generally participates in the social construction of knowledge (Vygotsky, 1978). Depending on the degree intelligence programmed into it, a lifelike pedagogical agent can provide learning support similar in important ways to that which the student would receive from human collaborators.

Recent survey articles (Kim M, 2003; Clarebout, 2002; Hongpaisanwiwat, 2002) and a few individual studies (Kim Y, 2003; Craig, 2002; Williams, 2004; Qi, 2002) show that the small amount of research on animated pedagogical agents has had little success. There are a number of possible explanations for this:

1. Pedagogical agents are not helpful. Given the successes that have been found with other types of agents, this is unlikely. Probably, they only need to be used correctly.
2. Introducing a pedagogical agent to a learning application changes the nature of the learning experience so much that comparisons between the agent and no-agent conditions are not meaningful. In effect, it becomes a cross-media comparison. While it is certainly possible that this is true for certain experiments, it seems unlikely that this is a problem with most experiments in this area.
3. The test measures are flawed. This is unlikely, given their long history and the number of experiments which use them successfully in other contexts.
4. Most implementations of pedagogical agents are poor, or they are not used well in the instructional design. Given the novelty and complexity of both the technology and its

educational use and the fact that the agent can affect the student in many ways, there are more opportunities for confusion and mishap. Also, the technology for animating visual agents can become very complex and difficult to implement successfully.

5. Pedagogical agents do facilitate learning, but not in ways captured by the outcomes measures, because the tool (the agent) may not be appropriate for the pedagogic goals of the test. I believe that this is the most likely explanation. The goals of Constructivist learning focus on higher levels of learning (i.e. transfer, learning how to learn and learning how to collaborate). These types of learning are not measured in many standardized knowledge tests which tend to emphasize factual and conceptual knowledge. While the experiment itself may not have been conceived as a Constructivist exercise, pedagogical agents appear to be best suited to that approach.

More research is needed to determine the best way to employ lifelike pedagogical agents, especially for Virtual Heritage applications. Of particular interest is discovering how to employ agents in ways that are uniquely advantageous, probably through student-and-agent role playing. Another important research direction is the development of more advanced displays which would allow students and educators to see more of the reconstructed environment(s) and interact with it in novel ways. The effective educational use of immersive displays is a primary concern for this review, and requires a careful examination of the existing research.

## 2.7.6 Current Activity in Virtual Heritage

Virtual Heritage is an active area of research, especially in the last seven years (Michell 2000, Champion, 2004a, 2004b, 2004c; Addison, 2000; Moshell, 2002; Roehl, 1997; Stone, 2002; Levy, 2004). This is due to the ubiquity of VRML, the rapidly declining cost of computer hardware and the growth of the World Wide Web. Now, a general trend in VR applications towards the use of computer game technology is making real-time animation and high detail affordable (Lewis, 2002; Dalgarno, 2002a; Young, 2000; Pivec, 2003b; Bruckman, 2002a; DeLeon, 2000; Tougaw, 2003; Stang, 2003; Jacobson, 2002a, 2004), and VH researchers are taking advantage of it.

Table 2 lists activity in the field along with the appropriate references.

**Table 2.** Virtual Heritage Projects

Dedicated conferences	VAST, 2005
Conferences which devote significant time to VH	VSMM, 2004; Eurographics, 2004; iGrid, 2000
Dedicated research labs, companies and organizations	Frischer, 2000, 2003; DWI, 2004; MIRALab, 2004; IAA, 2004; CVRLab, 2004; LearningSites, 2004; VHN, 2004; OnlineArchaeology, 2004; VirtualHeritage, 2004; VWAI, 2004
Individual projects	3Dweb, 2004; ACID, 2004; Arabesk, 2004; BBC, 2004a; BBC, 2004b; Beacham, 2004; Burgess, 1999; Dudley, 2004; Duran, 2004; Economou, 2001; Gauthier, 2003; Grajetzki, 2003; Holloway, 2000; Hughes C, 2001; Karabiber, 2002; Kufu, 2004; Kwon, 2003; Ledermann, 2003; Lehner, 2003; Levy, 2004; Hughes 2001; Nord, 2003; Oliverio, 2003; OsmosisInc, 2000; 2004; Park, 2003; Tam, 2004; Tennant, 2003; TimeRef, 2004; TrajanForum, 1999; TroiaVR, 2003; TutTomb, 2001; Udine3D, 2004; Ulicny, 2002; Valzano, 2004; ViHAP3D, 2004; VirtualArcheology, 2004; Zheng, 2000; Jacobson, 2004a

VH applications which employ computer game technology.	Stone, 2002; Economou 2001; Schulman, 1999; Champion, 2003, 2004b; OsmosisInc, 2000
Projects centered on reconstructions of architectural spaces. These virtual environments can be navigated, but are otherwise empty and not interactive. They are almost always part of some larger application or instructional design. Quality ranges from very simple to moderately complex, and all are useful.	Hughes C, 2001; Holloway, 2000; Frischer, 2000, 2003; Freudenberg, 2001; Beacham, 2004; Kufu, 2004; Learning Sites, 2004; Ledermann, 2003; Lehner, 2003; Levy, 2004; Oliverio, 2003; OsmosisInc, 2004; Ruiz, 2002; TimeRef, 2004; TrajanForum, 1999; TroiaVR, 2003; Valzano, 2004; Zara, 2003; Grajetzki, 2003; BBC, 2004a; Jacobson, 2004a
Virtual reconstructions of certain artifacts by optical scan.	Tam, 2004; Zheng, 2000
VE applications which use architectural reconstructions as their base environment, but are also responsive to the user in some way.	Udine3D, 2004; Arabesk, 2004; TutTomb, 2001; Jacobson, 1998
Architectural reconstructions which have autonomous agents populating the virtual space. The agents simulate the activities of ancient peoples performing daily living activities or religious rituals.	MIRALab, 2004; Ulicny, 2002; Gauthier, 2003; ACID, 2004; Karabiber, 2002; Papagiannakis, 2003, 2004b; Jacobson, 2004c
VH applications which have some degree of networking, allowing more than one user to enter the virtual environment.	Oliverio, 2003; Pape, 2000; Park, 2003; Jacobson, 2004a
Networked VR applications.	Raalte, 2003; Santos, 2002
Networked VR applications which resemble online communities.	SecondLife, 2004; There, 2004; MUVEES, 2004
Applications which use their multi-user capability to allow instructor/operators to control avatars to help create the experience for the user.	Hughes, 2001; Economou, 2001
VH applications where the most important information is convey through sound.	Karabiber, 2002
VH applications where the most important information is convey through touch.	Nord, 2003
VH applications which provide visual immersion for the user. Quality, capability and method vary widely.	iGrid, 2000; Pape, 2000; Park, 2003, Jacobson, 2004c, 2004d

<p>VH applications using augmented reality techniques. The user moves through an archaeological space and receives additional information in the form of imagery imposed onto or into his field of view. This creates the illusion that the computer generated objects and actors exist in the real world.</p>	<p>Papagiannakis, 2004a, 2004b; Ruiz, 2002; Sinclair, 2001; Addison, 2002</p>
--	---

While some projects employ immersive displays, the great majority of VH applications and activities employ Desktop VR. Based on statements of future and intended work appearing in the publications listed above, there is much interest in making the VH applications more dynamic and responsive to the user, especially with the introduction of animated agents. Accordingly the next two sections will look at research in adaptive hypermedia and lifelike pedagogical agents.



### 3.0 EXPERIMENT

In this chapter, we will describe the experiment at the heart of our study. After a brief introduction, we will discuss the contribution we hope to make the literature. Next, we will describe the learning game, *Gates of Horus*, which all students played and immersive and non-immersive interfaces which are the basis for our main experimental comparison. We formally state our hypotheses and describe in detail exactly who we were testing and what we can do. Next, we describe how we gather the data, and finally we list potential threats to validity of our expected results. We will detail and analyze the actual results in following chapters, but we can say we are pleased with the outcome.

### 3.1 INTRODUCTION

We hope to demonstrate that an immersive visual display is superior to a standard computer monitor for learning certain kinds of information which contain important spatial and visual elements. Specifically, we will investigate how well middle-school students learn Egyptian religious architecture using an interactive computer game. We will compare results achieved by students using a standard desktop computer monitor versus those using an immersive display

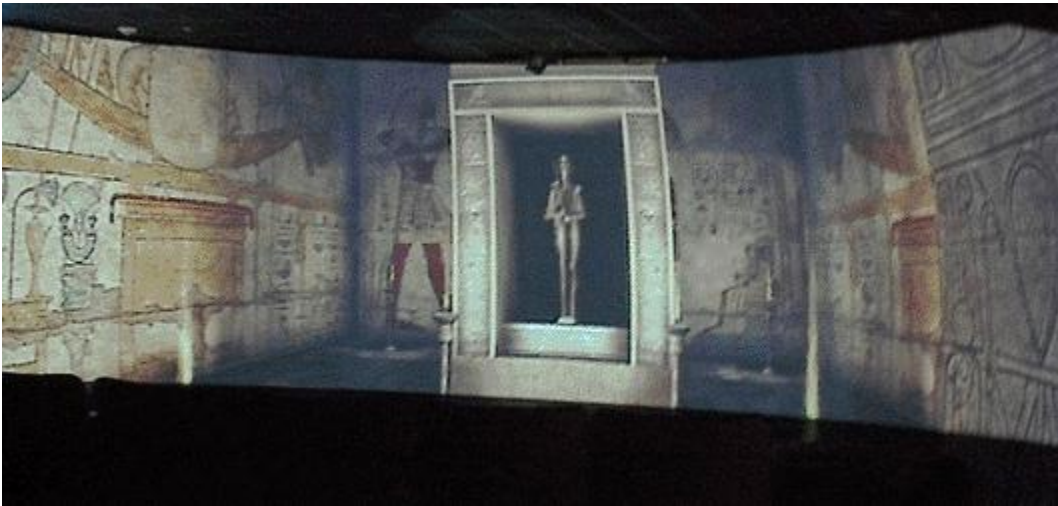

**Figure 18.** The Sanctuary of the Virtual Egyptian Temple displaying in the Earth Theater.

Students interacted with the material, by playing a learning game of our own design, called *Gates of Horus*, a single-student mystery-solving game. It features a simplified model of a classic late period Egyptian temple, which is designed to embody all the key features of such temples with a minimum of clutter. We chose this topic, because Egypt appears in most middle-school curricula, and the temple was the center of Egyptian public life. For each area of the temple, a pedagogical agent, the high priest, explains features of the temple when prompted by the student. To complete the game, the student must answer the priest's questions to open doors to progressively more secret and important areas of the temple. The student "wins" when s/he answers the final questions so that the god, Horus, will open a divine gateway and let the blessings of heaven flow to the land.

We conducted all testing at the Earth Theater of the Carnegie Museum of Pittsburgh, which features a partial dome display providing visual immersion for up to sixty people. From area schools, civic organizations, and individual families, we recruited eighty-five middle school students (grades 6-8) to come to the Earth Theater and play *Gates of Horus*. As each student came in, we randomly assigned each student to one of three groups. Each student in the **Theater Group** played *Gates of Horus* using the immersive dome display. Each student in the **Desktop Group** played the game on a standard desktop computer in an area adjoining the main theater. Members of the **Control Group** also played the game on a standard desktop but took the test for basic knowledge of the temple *before* playing the learning game. The Control Group's scores on the Post Test take the place of a knowledge pretest for the other two groups. This is necessary because any question-and-answer pretest given to the Theater and Desktop Groups would reveal too much information about the temple itself, and distort or ruin our test results.

We expected students playing the game with the visually immersive display to learn more information, retain it longer, and like it better. We also expected that students' scores on a visual reasoning test, Raven's progressive matrices (RPM), would be correlated with their test outcomes, in some way. Either students with low RPM scores will have more to gain from the immersive view or those with the high scores will (Bricken 1991; Winn 1997).

Here, we summarize the experimental protocols (section 0. p121), in the order the student experiences them:

- 1. Pretest:** Take a pretest for general information such as their attitude towards VR and Egypt.
- 2. RPM:** Complete a visual intelligence test, Raven's Progressive Matrices (RPM) (Shibly 1949; Gregory 1999). If in the Control Group, take a written Post Test, a fairly typical multiple-choice and short answer quiz. Then, proceed with the following tests.
- 3. Game Logs:** Play the learning game, *Gates of Horus*, to completion. The software logs all activity for later analysis.
- 4. Drawn Map:** Draw a map of the temple.
- 5. Magnet Map:** Place small magnets representing features of the temple on a correct map of the temple.

6. **Video:** Give a guided tour of the temple, navigating the model of the temple on the computer, explaining its purpose and features. The tour is videotaped and later scored by evaluators.
7. **Post Test:** If not in the Control Group, take the written Post Test, the same one member of the Control Group take before playing.
8. **Follow-Up:** One to two months later, the student completes an online quiz which measures knowledge of the temple.

We gathered results for the Pretest and the RPM test for comparative analysis with our primary measures of relative student performance. The other tests and the game itself provide measures which we used to directly compare average performance of students in the three groups. In this section we will describe our experimental design in more detail and how we instrument the protocols.

## 3.2 RATIONALE

The goal of our study was to determine whether a visually immersive display can have a provable advantage over a non-immersive display for topics in cultural heritage.

We chose the Egyptian Temple as the sample topic for our learning study, because the temple was absolutely central to their life and culture, *and* because is appropriate for the virtual reality medium. The temple itself, the hieroglyphics, the painted images, and the conduct of ceremonies are all tightly integrated. The physical space itself is the main semantic organizing principle. The temple is best viewed with the space intact from the vantage points from which it was meant to be seen. Visual Immersion takes this one step further, providing an **egocentric view**, which allows the observer to view the temple from the inside, as it was meant to be viewed in real life. To our knowledge, ours is the first formal experimental study in the use of Immersive VR for virtual heritage.

We chose the game metaphor for the advantages described in section 2.4.6, p38. With the temple, we saw a design opportunity in the information structure of the temple and supporting materials. We were able to structure the learning goals and activities in a way that is inextricable from the topic matter itself. See section 3.3, p98, for details. To our knowledge, only Winn (2001) structured an Immersive VR learning experiment as a game. Our study would be the second.

The most difficult and important goal of our study was to demonstrate how an immersive display could have more utility than a cheaper desktop monitor in a realistic situation. Several previous studies failed to do this (Moreno, 2002b; Byrne, 1996; Rose, 1996; Salzman, 1999) and only one succeeded (Salzman, 1998). Guided by Salzman's experiment, we structured our experiment in terms of the effectiveness of an egocentric view versus exocentric view, and their appropriateness for this particular topic matter. We also thought it important to test for the difference between short and long-term retention, and the interaction between students' level of visual skill and the display type.

We are pleased to report our study was successful in its major goals, which we will discuss in our conclusion section [7.0 p236](#). First, we will describe the learning game, our experimental design, and our basic results.

### 3.3 GATES OF HORUS

*Gates of Horus* is an educational game based on a Virtual Egyptian Temple (Jacobson, 2005e, 2004a), which provides both the content and the structure for our learning experiments. The temple has no real-world analog, although it is constructed mostly from elements of the Temples of Horus at Edfu (Arnold, 1999) and at Medinet Habu (Chicago, 1930). Its purpose is to embody the key features of the typical New Kingdom period Egyptian temple in a way that an untrained audience can handle. The temple consists of four major areas, the exterior (Pylon), the Courtyard, the Hypostyle Hall, and the inner Sanctuary, arranged in that order and separated by gateways.

Compared to a real temple, the virtual Egyptian Temple model is simple, having only enough detail to represent the key features required (Figure 19). For example, there is only one of each of the four types of areas, while an actual temple might have had several Courtyards and Hypostyle Halls. Similarly, the hieroglyphics are larger than they would be in an actual temple to make them more legible. There is a copy of the high priest in each of the major areas, functioning as a pedagogical agent. In this way, it is similar to the Virtual Notre Dame Cathedral (DeLeon 1999). Nevertheless, the scale and proportions of the spaces are correct, hieroglyphics make the appropriate statements, murals and statuary are in their proper locations, and so on.



Figure 19. Temple of Horus and the high priest

In the game, the student navigates the temple in a “first-person” view, where the view screen is made to look like a window onto the virtual world. The student is able to use the cursor to click on individual features of the Temple, which prompts the priest in that particular area to explain that feature’s meaning. To progress from one area of the Temple to the next, the student must answer all of the priest’s questions for that area. The questions are based entirely on what the priest has to say about that area’s active features. When the student correctly answers all of these questions, the Gateway to the next area the Temple opens which the student explores and learns about in the same way. The student wins the game when s/he answers all of the questions from the priest in the inner Sanctuary. Metaphorically, this makes the divine image of the God speak, and bring the blessings of heaven to the land of Egypt.

*Gates of Horus* uses CaveUT’s built-in logging functions to record everything that happens in the game. We make use of this in our experiments (section 6.2, p200).

### **3.3.1 Interface**

*Gates of Horus* is based on the two freeware packages, CaveUT and VRGL (Jacobson, 2005) and a commercial game, UT2004 (EpicGames, 2004). The student navigates and interacts using a mouse. In our experiments, students used a special type of cordless mouse, the Gyromouse (Figure 20, below) as a reasonably effective device for navigation and selection (Duncan, 2006; Herpers, 2005; Olwal, 2002; Patel, 2001; Hafner, 2000; Winograd, 2000). All of the test subjects played *Gates of Horus* using the Gyromouse, regardless of whether they were using a desktop computer or the immersive display.





**Figure 20.** The Gyromouse

To the operating system, the Gyromouse appears as a standard two-button-with-wheel mouse, but in practice it is somewhat difficult to use. By holding a trigger on the underside of the mouse, one could activate the ability to turn, which is then done by moving the mouse in the direction the student want to turn or look. The student can also move forwards and backwards by pressing the left and right mouse buttons. Finally, to exit navigation mode and to go into cursor mode the student presses the mouse wheel.

In cursor mode, the student can select an object by moving the cursor “over” it, treating the composite screen like a very large image map on a flat web page. However, the targeting is three-dimensional, allowing the student to select the same object from many directions. For example, Figure 21, below, shows a hawk statue in front of the temple with the targeting cursor over it. The cursor also indicates when it is over an active object by turning green (not shown). Down on the little mouse wheel changes the interface back to navigation mode.



**Figure 21.** Hawk statue and object selection cursor.

In the Desktop and Control conditions, each computer was equipped with a monitor, a keyboard (which went unused during game-play), the Gyromouse, and two headphones connected to the single sound port on the computer via a Y-splitter adaptor. During play, the student would hear the voice of the priest on one pair of headphones. During the training phase, a tester would wear the other headphones to hear the priest, also. In the Theater condition we used wireless headphones.

In the Theater condition, *Gates of Horus* uses CaveUT to display on the main screen of the Earth Theater, a multi-projector partial dome, shown here in Figure 22, Figure 23, Figure 24. The Gyromouse-based control of the cursor and general interaction with the game are exactly the same as with the desktop condition. However, using immersive display has a large practical effect in the way the student perceives the virtual space, navigates through it, and selects objects. For example, students with an immersive view often learn to (virtually) move less and physically look more, taking advantage of the wide view.



**Figure 22.** “Moving” through the Virtual Egyptian Temple in the Earth Theater.

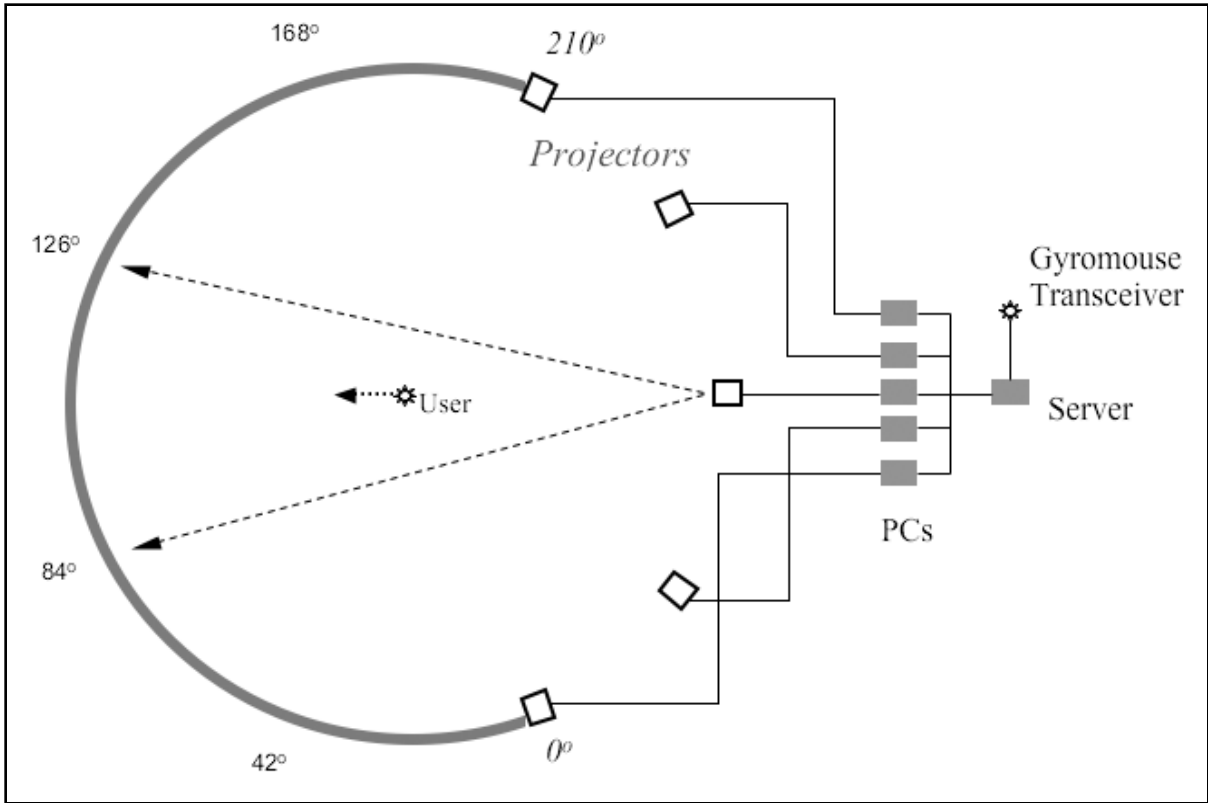

**Figure 23.** Overhead Diagram of the Earth Theater Main Screen

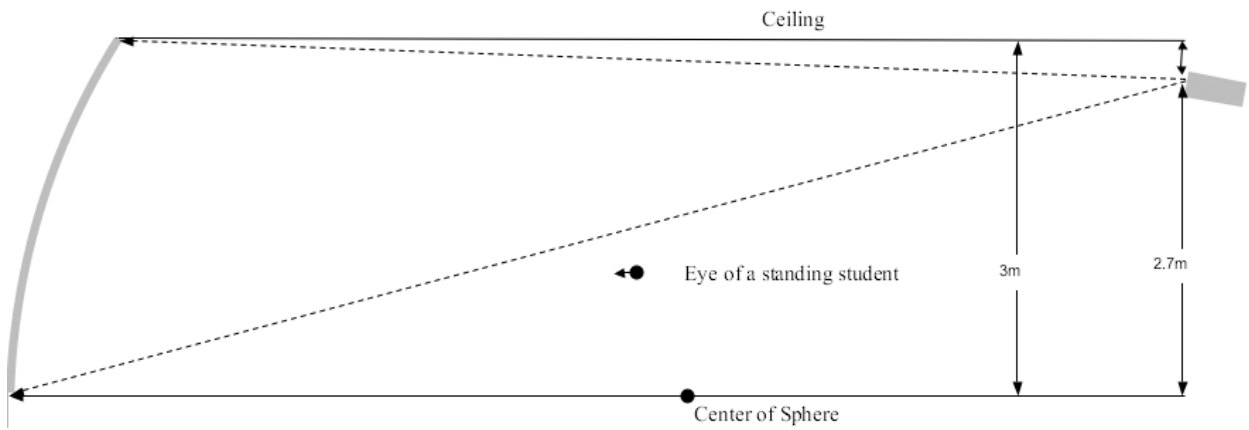

**Figure 24.** Side View Diagram of the Earth Theater

For the purpose of illustration, the person in Figure 22 is standing too close to the screen. In our experiment the student was located where Figure 23 and Figure 24 indicate, slightly forward of the center of the sphere defined by the curve of the main screen. We allowed the student to sit or stand, according to their wishes.

Interestingly, students who have played first person shooter games tend to waste the advantage of the immersive display by over-focusing on the center of the screen, navigating as they usually so in their desktop-centric games. Students, who have not played games of this type, tend to have a harder time learning to navigate, but develop better search strategies. Our (anecdotal) observation is that both types of students appear to do equally well.

### **3.3.2 Training Phase**

The student begins the game facing the side of the Temple, in the “Training Area.” The student will interact with the experimenter and with the software to learn how to play the game.

1. The training session begins with the student (virtually) facing the part of the temple shown in Figure 25, below. The experimenter demonstrates the proper use of the Gyromouse, and lets the student navigate around the exterior of the Temple, until s/he appears to be comfortable with it.
2. The experimenter then demonstrates object selection, again using the Gyromouse. The experimenter supervises the student as s/he selects random features of the temple, until the student appears to be proficient.
3. The experimenter asks the student to navigate back to where s/he began, to see the view in Figure 25, below.



**Figure 25.** Training Area

4. The experimenter directs to student to click on the priest, which triggers a voice recording, "Before you begin the game, we will show you how to play using this small example. You are looking at the Egyptian priest and side of the temple, which is behind him. On the wall, you can see that two human-like images are highlighted. Notice how they are facing each other and the things around them. Please click on each highlighted feature to find out what it is."
5. When the student clicks on the figure on the left, s/he hears a recording, "This is Pharaoh offering something good to the Ram-Headed god, Khnum." When s/he clicks the figure on the right, s/he hears "This is the Ram-Headed god, Khnum, receiving a gift from Pharaoh."
6. After having clicked on both figures and heard the recordings, the student hears, "Notice how the cursor changes color when it is over either one of the figures. Pay attention to the color of the cursor, because there are interesting things in the temple that you will want to click on, but they are not spotlighted. Next, you will have to answer a question. To answer 'yes' click the right mouse once. To answer 'no', click the right mouse button twice, quickly. This is sometimes called a 'double-click'. Please try it now."
7. From this point, on, each time the student single-clicks the priest, the recorded voice says, "Please try again. Click the right mouse button twice, as fast as you can."

8. When the student double-clicks, the priest said, "Good! Now make a 'yes' answer by clicking the mouse, once." Every time the student double-clicks, the priest says, "Please try again to make a 'yes' by clicking the right mouse button only once."
9. When the student produces a single-click, using the proper button, the priest says, "Good! Now, click on the priest, and answer his question with a 'yes' or a 'no'. When clicked upon, the priest asks: "In the mural in front of you, is Khnum reaching out for Pharaoh's present?"
10. Each time the student/student indicated, "Yes," the priest would reply, "Your answer is incorrect, please try again. Is Khnum reaching out for the present from Pharaoh??"
11. When the student answered "no," the priest said: "Correct. You are now ready to play the game. Please go to the front of the temple."
12. The experimenter directs the student to move to the front of the temple and moves the view to approximate the scene in Figure 19.
13. The experimenter gives the student four "hint" cards (Appendix D, p355) to help the student find the most difficult clues in each area. We had discovered the need for these during pilot testing.
14. The experimenter stays with the student, ready to answer questions, while the student works through the Pylon stage of the game. We collect and analyze data, while the student is working with the pylon, but we are careful about drawing any conclusions from it, because this is still a part of the training phase.
15. When the student has finished with the pylon, and the main gate of the temple opens, the tester leaves the student to complete the game.

### 3.3.3 Game Logic

The following is a description of the logic which supports the student's dialogue with the game. Because these are generic instructions on how to play the game, we use the present tense.

**3.3.3.1 Definitions** We use the following terms in all further discussion of the Temple and the experiment.

- 1. Area:** There are four *areas* associated with the temple, the Pylon, Courtyard, Hypostyle Hall and Sanctuary. The interaction logic for each area is the same, except where noted.
- 2. Priest:** Each Area also has a *priest* standing near the closed gate to the next area.
- 3. Goal:** Each Area has a *goal*, which is a concept or idea. The goal has two or more questions associated with it.
- 4. Clue:** A *clue* is one of the short voice recordings which explain something. For example, when the student clicks on the hawks on the ceiling, the recording it triggers is called the Ceiling clue. Each goal has two or more questions associated with it.
- 5. Feature:** Each clue is associated with a temple *feature*, which can be anything. Some features are spotlighted. When the cursor is over any active Feature, the cursor changes to the “active” color.
- 6. Activate:** When the student clicks on a temple Feature, s/he *activates* the clue associated with it. Until that clue is Complete, it is activated.
- 7. Introduction:** Each Area has a clue called *Introduction*, and its Feature is a particular patch of ground. For the Pylon, it is the Area in front of the temple, large enough to find easily and with some “empty” space between it and the temple itself. For the Courtyard it is the Area just inside the door from the outside. For the Hypostyle Hall, it is the Area near the door to the Courtyard, and for the Shrine it is the Area near the door to the Hypostyle Hall. Of the last three, each one is positioned so that the student will (virtually) enter it the first time s/he enters the Area. The intro Area is indicated with a ring-of-smoke effect just over ground. In all other ways, each Introduction is functionally the same as all the other clues.
- 8.** Each clue has several *Questions* associated with it. The questions are always in yes/no form, and always asked by the priest in the room.



9. Each clue also has a *View* associated with it, which is the ideal (virtual) location and orientation for the student to see the corresponding feature of the temple.
10. When the student has correctly answered enough of the questions associated with a view, we say that the clue is *Complete*. Similarly, a Goal is completed when all of its questions are answered correctly.
11. Until all of the clues have been Completed, there is always one and only one clue that is called the *Current Clue*. It is always (1) Activated (2) not Complete and (3) the clue most recently clicked. There could be two or more clues that the student has heard, but which are not complete. The Priest keeps track of which clues are currently Active and the student's most recent answer to each question already posed to the student.

**3.3.3.2 Actions** Here, we characterize the basic rules of the game.

1. The student may trigger an Introduction audio recording, **only once**, by (virtually) walking onto the area associated with it. Entering the area again will not trigger the introduction recording. However, the student may trigger the introductory recording at any time by clicking on the floor just inside the door to the area. That part is indicated by the smoke ring effect.
2. Each time the student clicks on the priest agent, s/he will hear questions associated with features in the area or goal questions about the area as a whole. The student answers with a Yes or No, using the buttons on the mouse. If the student immediately clicks on the priest, again, the priest will repeat the question.
3. Once a student has answered a question correctly, the priest will never ask it again.
4. If a student has answered a question incorrectly, the priest will ask some other question associated with the same clue. Only if no other questions remain will the priest ask the incorrectly answered question immediately again.
5. If the student's answer is his or her *second* wrong answer for that clue *since the time that clue's recording played*, the student's view will automatically move to that clue's view and the student will hear the clue's recording play again.

6. The student may click on an active feature at any time, eliciting the clue's recording. If that clue is **not** Complete, it will become the *Current Clue*, regardless of whether one or more clues are currently active.
7. When the Current Clue is completed, a previous clue that the student has heard, but has not completed, will become the new Current Clue. If no clues are active, but there are still clues the student has not yet heard, the priest will instruct the student to go hunt for more clues.
8. When all clues in an area are complete, the priest will ask questions related to the goal. When the goal is complete, the priest will congratulate the user and the gate to the next area will open.
9. When the student successfully answers all questions for the sanctuary, the "god" will speak, congratulating the student on winning the game.

#### **3.3.4 Statements and Questions**

This section gives the full text for each clue in the Temple, the questions associated with each clue, and the goal questions associated with each area. The name of each clue indicates the feature to which it is attached. Each clue is preceded by its name and a description of how to activate it. Each question is followed by its correct answer in parentheses. Because this is generic information about the game, we use present tense.

**3.3.4.1 Pylon** Here, we describe each clue associated with the pylon (front) of the Temple, and all the questions associated with each clue. In each description, the first sentence describes the action the user must take to *Activate* the *Clue*. The second sentence gives the text of the Clue as the student hears it. Each question is followed by its correct answer.



**Figure 26.** The Pylon

**1. Intro:** To hear this clue, the student enters a white circle on the (virtual) ground, which marks a touch-trigger volume in the front of the temple. "The very large front of the temple is called the 'Pylon'. It is gigantic, impressive, and colorfully decorated, but the colors have faded away over time. The massive east and west halves represent the mountains on either side of the Nile. The Pylon is a symbol of what Egypt could be." To hear the introduction, again, the student can either go back to the starting position (in the circle) or click the circle.

**Q1.** Is the whole temple as massive as the Pylon? (no)

**Q2.** Was there originally more color in the decorations on the Pylon? (yes)

**Q3.** Just from what you see of the Pylon, does the temple seem well ordered and designed? (yes)

2. **King:** Click on the very large scene spotlighted on the left part of the temple. "Pharaoh is depicted on a grand scale, shown defeating the enemies of Egypt. The god grants Pharaoh the power and authority, represented by a sword. The Egyptians believed that this was the way things were supposed to be."
  - Q1. In the battle scene, is Pharaoh winning? (yes)
  - Q2. In the battle scene, is the god also beating Egypt's enemies? (no)
  - Q3. Do the gods give Pharaoh the authority to defeat the enemies of Egypt? (yes)
3. **Hawk:** Click on either hawk statue flanking the Main entrance. "I am Horus, the god of Kingship. The hawk is my symbol and this is my temple. The image of Pharaoh beneath the hawk's breast shows that I protect him, for Pharaoh and the gods are united for the good of the world. I represent all gods, and Pharaoh is the link between the people and the gods."
  - Q1. Is there disunity between the gods and Pharaoh? (no)
  - Q2. Does the hawk show that this is the temple of Horus? (yes)
  - Q3. Is it important that the hawk statue protects a little king statue? (yes)
4. **Disk:** Click on the winged disk over the main gate. "The winged disk is a symbol of unity and protection, helping to guide you through the temple. It represents the divine life-force which flows from heaven and into all things. The disk is a symbol of the world according to the Egyptians, representing creation, life and especially protection. "
  - Q1. Does the winged disk represent unity? (yes)
  - Q2. Does the winged disk guide you through the temple? (yes)
  - Q3. Does the winged disk represent war? (no)
5. **Pylon Goal Questions:** The Priest asks these, when the student has answered all of the other questions about the Pylon.
  - Q1. Did the Egyptians think the world was orderly? (yes)
  - Q2. Does the scene where Pharaoh is beating the enemies of Egypt show what the Egyptians wanted? (yes)

If the student's answers to these questions are satisfactory, the gates to the Hypostyle Hall will open.

**3.3.4.2 Courtyard** Here, we describe each clue associated with the Courtyard of the Temple, in the same way we did for the Pylon.

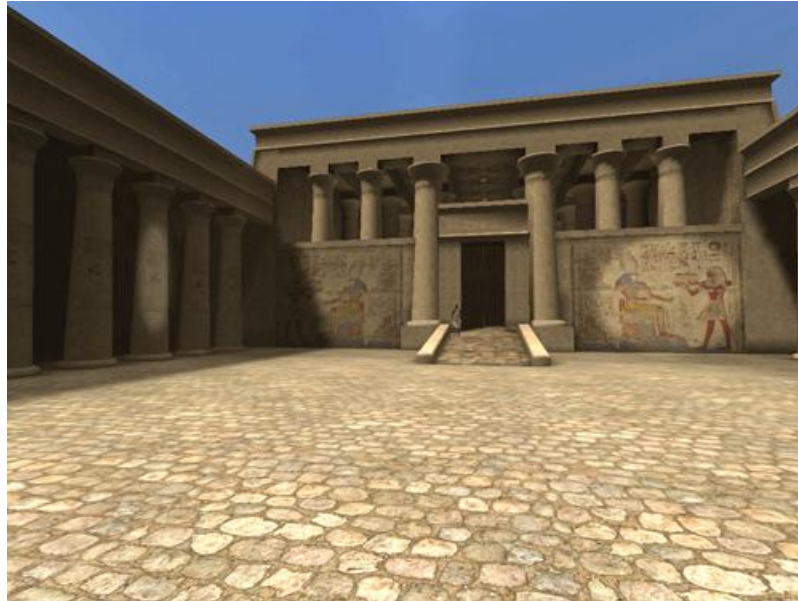

**Figure 27.** The Courtyard

- 1. Intro:** Enter the Courtyard. "The Courtyard is an open and undivided space, made for large religious celebrations and rituals. Everyone comes to these events dressed in the same simple garments. They do this to show how all people are equal and humble before the gods."
  - Q1.** Does Pharaoh come to the Courtyard, sometimes? (yes)
  - Q2.** Can ordinary people go to the Courtyard? (yes)
  
- 2. Floor:** Click on the floor. The floor's trigger-volume was centered on the courtyard, filling about two-thirds of the space. It stops short of the columns and the ramp into the Hypostyle Hall. To hear the introduction, again, go back under the courtyard gate to leave the trigger volume, or click on the area under the door. "The Courtyard was a wide open space, without subdivisions. It held large religious celebrations and rituals. Everyone dressed in simple garments to show that they are humble before the gods."
  - Q1.** Is the Courtyard divided into different areas for different people? (no)
  - Q2.** Do rich people wear fancy cloths during the celebrations here? (no)

3. **Sky:** Click the sky above the Courtyard. "The open sky over the Courtyard reminds us of the connection between heaven and earth. All Egypt is united under the sun, which embodies the creator god, Amon."
  - Q1. Does the sun embody the god, Amon? (Yes)
  - Q2. Was there a purpose to having no roof over the Courtyard? (yes)
  
4. **Festival Scene:** Click on either wall, behind the columns on the long sides of the space. The trigger volumes should approximately run the length of each wall, except for a blank spot behind the spotlighted column. "The celebrations here are joyous events showing the peoples' gratitude to the gods. It is a sacred duty, a serious business, but also an enjoyable one. Everyone brings the best things they have to give, as further offerings of gratitude."
  - Q1. Do people come to the Courtyard to complain to the gods? (no)
  - Q2. Do the people give their worst things to the temple? (no)
  
5. **Offering Scene:** Click on the spotlighted offering scene to the right of the gateway to the Hypostyle Hall. "On behalf of all Egyptians, the King gives thanks by offering 'every good thing' to the god, who is their creator. In return, he blesses the King, the land of Egypt and its entire people with life and prosperity forever."
  - Q1. Does Pharaoh represent the people's interest before the gods? (yes)
  - Q2. Do the gods give the King something in return for his offerings? (yes)
  
6. **Columns:** Click on the spotlighted column. "The king and god embrace, representing humanity and divinity coming together in a public way. The King represents all Egyptians, while Horus represents both the gods and the natural world."
  - Q1. Do the king and Horus spend all their time in the Courtyard? (no)
  - Q2. During the celebrations, were the god and Pharaoh symbolically there? (yes)
  
7. **Courtyard Goal Questions:** The Priest will ask these, when the student has answered all of the questions, above.
  - Q1. Did the people give thanks to the gods as a community? (yes)
  - Q2. Did the people bring gifts with them to the festival? (yes)

If the student's answers to these questions are satisfactory, the gates to the Hypostyle Hall will open.

**3.3.4.3 Hypostyle Hall** Here, we describe each clue associated with the Hypostyle Hall of the Temple, in the same way we did for the Pylon.



**Figure 28.** Hypostyle Hall

1. **Intro:** Enter the hall to trigger the recording. To hear the recording again, go back under gate from the Courtyard to leave the trigger volume, then enter it again, or click on the area under the gate “Unlike the Courtyard, the Hypostyle Hall was a quiet and private place. Only the literate people, the upper class, ever came here. They conducted small private ceremonies to honor their ancestors. This is another way for the people to connect with heaven.”
  - Q1. Do people revere their ancestors here? (yes)
  - Q2. Can anyone come to the Hypostyle Hall? (no)
  - Q3. Do worshippers in the hall connect with heaven through their ancestors? (yes)
  - Q4. Is the Hypostyle Hall a public space, like the Courtyard? (no)
2. **Lamps:** Click any one of the lamps. “The Egyptians remember and revere their ancestors by making offerings and prayers to them. These offerings are placed before statues and images of their ancestors, which are kept in homes and workplaces. Those who make great gifts to

the temple may have family offering places inside the Hypostyle Hall, a place of great honor.”

**Q1.** If you make a big donation to the temple, can you put a statue of your ancestors in the hall? (yes)

**Q2.** Could anyone have a statue or offering table in the Hypostyle Hall? (no)

**Q3.** Can a poor Egyptian still have an ancestor statue or offering table at home or at work? (yes)

**3. Columns:** Click the highlighted column. “The Hypostyle Hall is filled with plant-form columns which represent the primeval marsh. This marsh surrounded the first mound of land, which rose from the waters at the beginning of time. It is built on a grand scale to let you know that you are in a sacred space.”

**Q1.** Do the plant-form columns represent broccoli? (no)

**Q2.** Do the columns have a special meaning? (yes)

**Q3.** Do the columns represent the primeval marsh at the beginning of time? (yes)

**4. Ceiling Hawks:** Click on the center strip of the ceiling, the part with the hawks printed on it. “The hawks on the ceiling are spirit guides leading into the temple, showing the connection between heaven and earth.”

**Q1.** Do the spirit guides on the ceiling show the connection between heaven and Earth? (yes)

**Q2.** Do the birds on the ceiling lead you out of the temple? (no)

**5. Hypostyle Hall Goal Questions:** The Priest will ask these when he decides that the student has answered enough of the questions, above.

**Q1.** Is the Hypostyle Hall an intimate space? (yes)

**Q2.** Does the hall support a private connection to the divine? (yes)

If the student’s answers to these questions are satisfactory, the gates to the Hypostyle Hall will open.



**3.3.4.4 Sanctuary** Here, we describe each clue associated with the Hypostyle Hall of the Temple, in the same way we did for the Pylon.



**Figure 29:** The Sanctuary

- 1. Intro:** Enter the Sanctuary to trigger the recording. To hear the recording again, the student can click in the floor underneath the doorway. “The Sanctuary is the most central, the most important place in the temple. Its decorations are of the most intricate and excellent workmanship, all made of the best materials. The most important ceremonies happen here.” No questions are associated with this statement.
- 2. Back Wall:** Click on the spotlighted Pharaoh. “Only the King or the High Priest (acting in his stead) could conduct worship services here. Ordinary folk never saw the Sanctuary.”
  - Q1.** Could an ordinary person worship here? (no)
  - Q2.** Did Pharaoh represent the community here? (yes)
  - Q3.** Is the Sanctuary the least important place in the temple? (no)

**3. Floor:** Click on the spotlighted spot on the floor. “The ground under the Sanctuary is the primordial mound, the very first place in both space and time. People in every town in Egypt think that the world began under their local temple.”

**Q1.** Did the local Egyptians believe that the world began on the ground where their temple is built? (yes)

**Q2.** When the world was created, was the ground under the Sanctuary created last? (no)

**Q3.** Did the local Egyptians think that time began where their temple is built? (yes)

**4. Shrine:** Click on the top of the shrine. “The Shrine was the gateway between heaven and earth, from which the blessings of heaven would flow, but only if proper ceremonies were conducted correctly. It is the god who opens this magical gate.”

**Q1.** Is it important for the Pharaoh or the High Priest to do the ceremonies correctly? (yes)

**Q2.** Do the blessings of heaven come out from the shrine? (yes)

**Q3.** If asked correctly, would the gods help the people? (yes)

**5. Divine Image:** Click on the figurine in the shrine. “Standing in the shrine, the divine image of Horus represents all gods. At times, it is inhabited by the spirit of the god, who influences events for the benefit of the community. For example, if the gods were pleased, they might bring a good harvest to the land.”

**Q1.** Is the statue of the god just a statue to the Egyptians? (no)

**6. Sanctuary Goal Questions:** The Priest will ask these when he decides that the student has answered enough of the questions, above.

**Q1.** Does Pharaoh communicate with the gods here? (yes)

**Q2.** Is there anything more important than what happened in the Sanctuary? (no)

**Q3.** In this temple, does Horus represent all gods? (yes)

When the student has answered these questions satisfactorily, the following recording plays: “Congratulations young one! You have unlocked the secrets of my temple. When you are King, you will come here to make the offerings, so that the gods will bless the people and land of Egypt, forever. This is your power, your right and your duty.”

Figure 30 shows the trigger volumes in the Temple. to trigger a recording, the student either touches the area (steps into it), or clicks on it with the cursor.

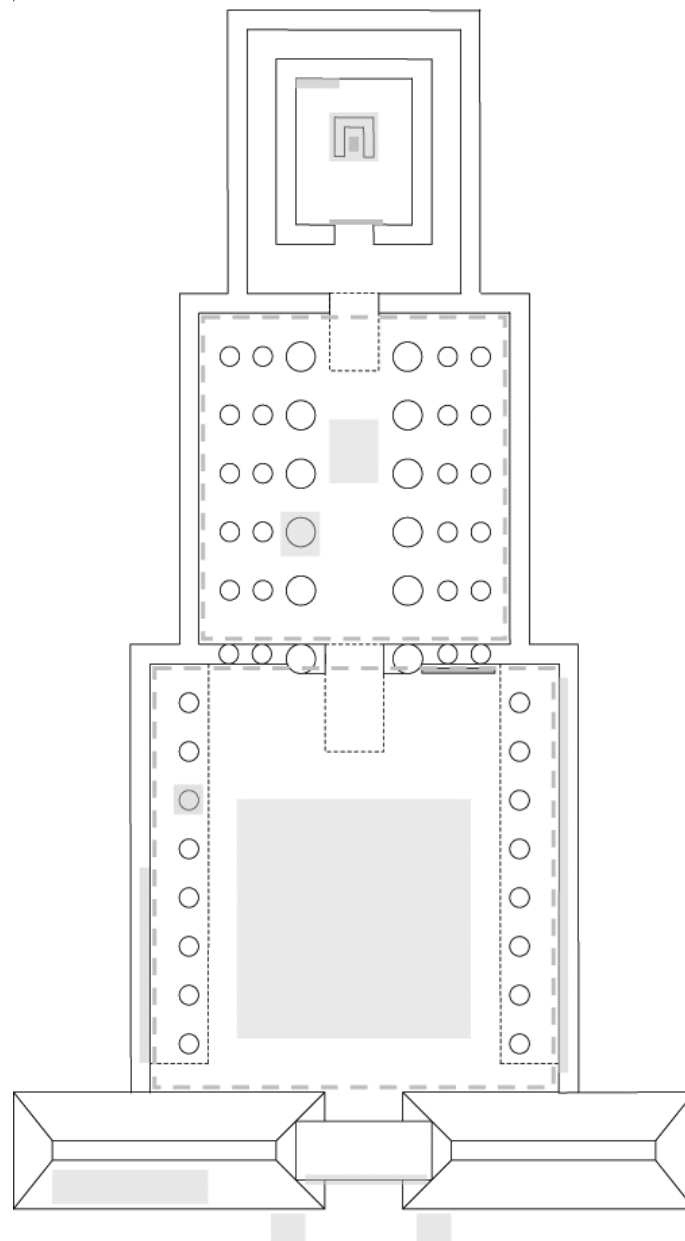

**Figure 30.** Gates of Horus Trigger Volumes in the Temple

### 3.4 HYPOTHESES

Two hypotheses H2 and H3, embody the primary goals of the study. H1 plays a supporting role while H4, H5 and H6 refine the possible results found in H2 and H3. Many other comparisons are possible using additional measures (e.g., age, gender, computer literacy) which we gathered for their anecdotal value. However, such comparisons would not fall within the *a priori* goals of the study, making the occasionally significant result suspect.

- **(H1)** Students who play *Gates of Horus* (section 3.3, p98) to completion learn more of the facts and concepts of the Virtual Egyptian Temple than those who have not. This would be proved if Post Test scores for students in the Control Group were significantly worse than scores for all students in the other two groups taken together. Failure to find a significant difference would indicate a failure of either the learning experience itself or the testing procedures.
- **(H2)** Students in the Theater Group learn more facts and concepts than the others. This would be proved if students in the Theater Group generally scored higher on the Post Test or the Video Test than those in the Desktop Group. It would also be proved if students in the Theater Group scored higher than all students in the other two groups taken together. While this conveys the statistical advantage of comparing larger groups, it gives the aggregate non-Theater Group an unfair advantage in the Video Test. Students in the Control Group had more exposure to the material because they took the Posttest first. If there is no significant difference, the positive effects of using the Theater would have to be stronger.
- **(H3)** One or two months after playing *Gates of Horus*, students in the Theater Group will remember more conceptual and spatial knowledge than those in the Desktop Group. This will be reported in the Follow-Up test.
- **(H4)** Students in the Theater Group will learn more of the (spatial) structure and features of the temple than those in the other two groups, taken together. The literature on spatial navigation training in VR indicates this is a very likely result.

- **(H5)** One or two months after playing *Gates of Horus* (section 3.3, p98), students in the Theater Group report more motivation to learn about Egypt and a more positive view of their experience. This is reported in the Follow-Up test. The Educational VR literature indicates that this is a very likely result.
- **(H6)** We expect students' scores on the Raven's Progressive Matrices (RPM) to interact with the experimental results for the Post Test, video test, or Follow-Up test. The immersive view conveys more advantage either to students who score high on RPM or those who score low.

Our most important goal is to prove **H2** or **H3** to show that visual immersion helps children learn more about Egypt, a common topic in middle-school curricula. However, we must prove **H1** first, because the game has to be shown to be effective for learning before we can use it for student-interface comparisons. Good computer learning games are difficult to produce, many VR applications fail (section 2.6.4, p66), and *Gates of Horus* is both. We investigated **H4** because superior spatial learning is widely reported in the VR training literature (Darken, 2001). We investigated **H5**, because enjoyment of VR interfaces is widely reported in VR literature.

We included **H6**, because Raven's Progressive Matrices (RPM) (Shiply, 1949; Gregory, 1999) measures students' basic spatial and spatial-analogical reasoning ability without the use of language. One might expect those who score highly on Progressive Matrices to do better in the Post Test results because of their higher spatial ability. The reverse may occur, however, with the students of lower spatial ability benefiting more from having the temple visualized for them by the software (Merideth Bricken, 1991). There is some indication in a study by Winn (1997) that low-achieving students had more to gain, on average, from Winn's VR learning application.

### 3.5 TEST POPULATION AND PILOT STUDY

For this study, we recruited middle school students in grades six through eight, ages 11 through 14, from Pittsburgh area schools, civic organizations, and patron-members of the Carnegie Museums of Pittsburgh. (Appendix D, p354) We believe that *Gates of Horus* (section 3.3, p98) is appropriate for this age group, and relevant to most primary school curricula. The students are old enough to handle the material and the test instruments but young enough to be enthusiastic about planned-learning activities. The interactive game-like quality of the experimental learning exercise is often familiar to them from the video games they may already play. Also, middle-school students may remember activity-oriented learning experiences from elementary school. Finally, Egypt is popular with the children of the museum-going public. At the Carnegie Museum of Natural History, attendance in the 5<sup>th</sup> floor Egyptian exhibition is second only to that of the dinosaur exhibits.

Each student interested in the study and his or her parents or guardian were granted free admission to the Carnegie Museum of Natural History for the day of the test regardless of whether the student agreed to participate in the study. Upon completion of testing in the Earth Theater, students received an informational booklet which gave more information about our virtual Temple and Egyptian temples generally. Upon completion of the Follow-Up Test (section 6.6, p221) students received by mail a DVD containing a copy of the tour of the temple they produced during the Video Test. They also received a \$5 gift certificate to the Carnegie Museum Store.

Kerry Handron, the director of the Carnegie Museum's Earth Theater, and Jeffrey Jacobson, the principal investigator of this study, served as "testers" supervising the testing and management of the student, with occasional help from Ms. Handron's assistants. All testing was individual to each student, but we employed Earth Theater facilities to handle up to six students at any one time.

The first seventeen students we recruited became pilot testers; we used their comments and learning outcomes to refine the testing procedures. We also used lessons learned from the pilot study to refine our experimental design, primarily to mitigate threats to validity (section 3.8, p133). We saved the data gathered from the pilot study for its anecdotal value, but we did not use it in any formal analysis.

We had 17 pilot testers, 21 in the Control Group, 20 in the Desktop Group, and 27 in the Theater Group, for a total of 85 subjects. (The *pilot test* is a dry run of the entire test protocol intended to eliminate bugs in the procedure, the software, or even the design. Data gathered in the pilot tests are not used in any of the analysis.) To improve the validity of our study, we successfully recruited students from a range of economic strata and geographic areas, including students from disadvantaged groups.

### 3.6 TESTING SEQUENCE

This section describes the full sequence of student and tester actions during an individual student's testing session.

1. Upon arrival, the student had to have a consent form signed by a parent or guardian (Appendix D, p346).
2. The tester explained to the student what the study entailed and obtained the student's written assent. *The student was free to withdraw from the study at any time for any reason or no reason.* Few did.
3. The tester asked each student who agreed to be in the study to invent a code name for him or herself. This code was used to identify the student's test results and related records to protect his or her privacy. The tester wrote the code on the student's parental permission form and stored the forms in a locked filing cabinet in Kerry Handron's office. The student or the tester tagged every test the student took with his or her code name; it was also put on the game logs.
4. The tester randomly assigned the student to an experimental group (Control, Desktop, or Theater) and wrote the date, the group, and the student's code name on the front page of a blank testing packet (Appendix B, p307). The packet contained instructions for the tester and some of the actual tests the student took. Throughout the experiment, the packet had to either stay with the student or be carefully associated with him/her in some way. The tester took the student to a desk with a standard desktop computer, monitor, keyboard and mouse. Desks were located in quiet side rooms adjoining the Earth Theater.

5. Student completed the Pretest (section 6.1, p198) on the computer.
6. Student completed the Raven's Progressive Matrices test (section 5.6, p188).
7. If the student was in the Control Group, the tester launched the Post Test (section 4.0 p136) which the student completed. The student then continued with the next step, like the other students.
8. If the student was in the Theater Group, the tester took him/her to the proper viewing/control location in the Earth Theater. In effect, the student used the Earth Theater's server computer as s/he would use a desktop, except for the difference in the display. The student stayed at the desktop computer if s/he was in the Control Group or Desktop Group.
9. The tester worked with the student to complete the training phase of the *Gates of Horus* game (section 3.3, p98).
10. The student completed the first part of the game, centered on the Pylon. During this phase of the game, the tester coached the student on navigation, selection and game play as needed. Before the student (virtually) entered the Courtyard, the tester gave him/her *Hint Cards* (Appendix D, p355) to help find the most difficult clues. We added the Hint Cards, because pilot testing revealed that the game was too difficult for students to complete within the desired time limit.
11. The student completed the *Gates of Horus* learning game (section 3.3, p98), usually in 45 to 60 minutes.
12. Student completed the Presence and Comfort test (section 6.3, p204) which is quite brief.
13. The tester took the student to a desk in the testing room, usually the one where the student started.
14. Student completed the Drawn Map Test 6.4, p208)
15. Student completed the Magnet Map Test (section 6.5, p215).
16. The tester led the student to a separate room where s/he completed the Video Test (section 5.0 p154).



- 17.** If the student was in the Theater or Desktop Group, the tester conducted the student to a desktop computer where the student completed the Post Test (section 4.0 p136).
- 18.** The tester asked the student to log in to a special website, one month later, to complete the Follow-Up Test (section 6.6, p221).
- 19.** The tester conducted a short Exit Interview, asking the student for his or her impressions and opinions of the testing process. During the interview, the tester gave the student a booklet with more information on Egyptian temples and culture with references to online resources for Egyptian history. The tester also informed the student of the Egypt Hall exhibit on the Fifth Floor of the Carnegie Museum.
- 20.** Four weeks after the VR experiment, we wrote to the student's parents to remind them of the Follow-Up Test (section 6.6, p221), the student's personal code, and the payment the student will receive for completing the test (Appendix D, p352).
- 21.** The student took the Follow-Up Test (section 6.6, p221) via the internet, using any computer with a web browser. The student was expected to use a computer at home or school or at the public library.
- 22.** To each student who completed the Follow-Up test, we sent a recording of his or her video on a CD-ROM, a \$5 gift certificate for the museum store (Appendix D, p352), and our thanks section (Appendix D, p353)

Inevitably, the testing itself was part of the student's experience, and order effects were probably significant. Each knowledge test gave the student a chance to elaborate and organize what s/he knew, as well as providing additional information on the material. Rather than attempting to control for ordering effects, we employed them as part of the learning curricula, testing all students in all groups in the same order.

## 3.7 DATA GATHERING

This section describes the observation methods and test instruments we will employ to evaluate students' learning.

### 3.7.1 Online Evaluation Forms

All student data and all evaluation forms are made available to the graders online, with only two exceptions. We sent the videos on television-format DVDs and Dr. Holden's evaluation forms were written. This allowed the graders to conduct their evaluations regardless of physical location, and eliminated the need to manually enter their grades to the database. Figure 31 shows a small example, the first part of the Post Test (section 4.0 p136).

The Post Test was accessible through a specific URL on this survey monkey site, in the "area" designated for our study. We can log in with a password to edit the questionnaires, download data, and perform other functions. While the survey is marked "open," anyone on the Internet can access it, enter data, and send in answers. In practice, the URL is so cryptic that there is no way anyone could find it unless we provide it. We stored the link in the shortcut on the desktop of each one of the testing machines, so the tester only needed to double-click the shortcut to call up the Post Test.

Many of the questions in the Post Test were automatically scored, being multiple-choice questions of some type. However other questions were short-answer, which requires human interpretation. We wanted each required to be able to assign-certain number of points to each student's response to each question. Given certain limitations in survey monkey at the time, we chose to make an individual grading form for every student who took the Post Test. Figure 32, p127, shows a sample page.

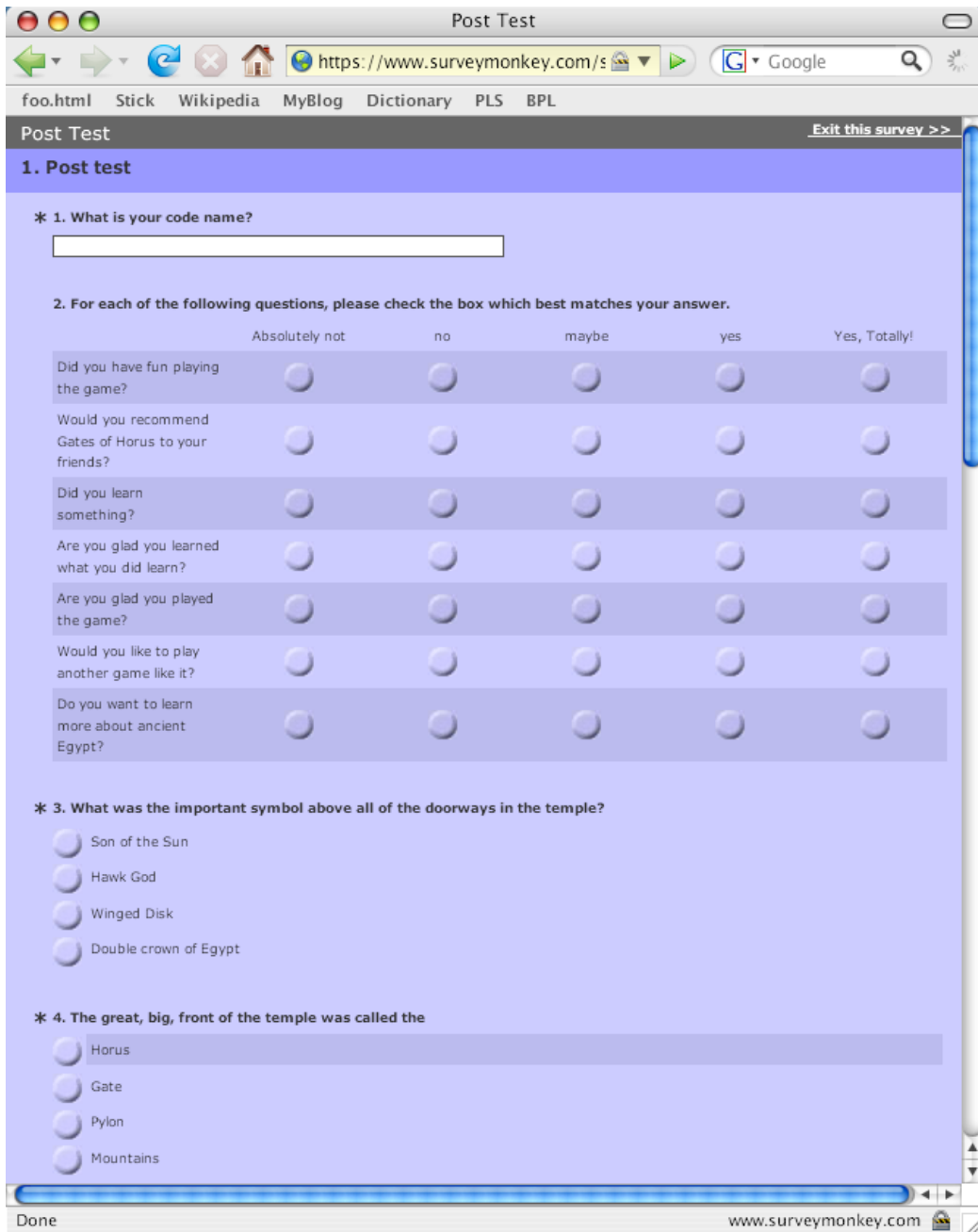

Figure 31. Sample page from the online Post Test

KimKim (PostTest)

http://www.surveymonkey.com/s.z

foo.html Stick Wikipedia MyBlog Dictionary PLS BPL

KimKim (PostTest) [Exit this survey >>](#)

### 1. KimKim (PostTest)

**1. Grader Name**

This grading form is individualized to the above named student. It asks you to evaluate their students' performance on those questions from the post test which we require human judgment.

In grader-questions 2-6, below, the original student-question appears in italics followed by the students answer. Below that is a list of ideas or characteristics that the student answer may have or contain. Use the button bar to the right to give the student no credit, half credit or full credit for that aspect of their answer. Question seven and eight have a similar format, them but the grading choices are somewhat different. The last question provide a space for your general comments.

Do not worry about the credit or points assigned to each question. The relative weights given to the answers will depend on the goals of the data analysis, and we will look at the data in several different ways. We will figure all that out, later.

**\* 2. *What was the important symbol above all of the doorways in the temple?*** \_\_\_\_\_.

**Winged Disk**

	none	half	full
The winged disk.	<input type="radio"/>	<input type="radio"/>	<input type="radio"/>

**\* 3. *What does the Pylon tell us about how the Egyptians wanted the world to be like?***

**perfect....**

	none	half	full
Orderly	<input type="radio"/>	<input type="radio"/>	<input type="radio"/>
Ruled by Egypt	<input type="radio"/>	<input type="radio"/>	<input type="radio"/>
Pharaoh rules Egypt	<input type="radio"/>	<input type="radio"/>	<input type="radio"/>
Pharaoh has the support of the gods	<input type="radio"/>	<input type="radio"/>	<input type="radio"/>
Other1	<input type="radio"/>	<input type="radio"/>	<input type="radio"/>
Other2	<input type="radio"/>	<input type="radio"/>	<input type="radio"/>

**\* 4. *What did people do in the Courtyard?***

**have parties and festivals**

	none	half	full
Had great public festivals for everyone	<input type="radio"/>	<input type="radio"/>	<input type="radio"/>
Dressed simply to show their humility before the gods	<input type="radio"/>	<input type="radio"/>	<input type="radio"/>

Done

Figure 32. Sample page from the online Grading Form for the Post Test

As you can probably see in the instructions on the sample form (Figure 32, above), the original question is shown in italics after an asterisk, while the student answers are shown in plain text. The number of each question is the number as it appears on the original test. For question two in Figure 32, above, the grader has three choices for assigning data, none, half-credit, or full-credit.

This is equivalent to a three-level Likert scale. While five level Likert scales are common and easy to work with in data analysis, we felt that five levels would convey no more true information. In the case of question number two, what would one quarter credit or three quarters credit really mean? As it is, a half credit answer means that the student indicated something very similar to the winged disk or alluded to it.

### 3.7.2 Multiple Evaluators

We will employ four outside experts to evaluate test results:

1. Two middle and high school teachers, Kathy Bruckner and Adrienne Baker.
2. Jane Vadnal, an expert art historian, but not an Egyptologist.
3. Benjamin Getkin, tour guide for the Virtual Egyptian Temple at the Museum. *Gates of Horus* was built on the educational materials surrounding the virtual Egyptian Temple.

All four of them evaluated the open-ended student responses in the Post Test and Follow-Up test, and then evaluated (student-made) Drawn Maps, Magnet Maps and Videos. Additionally, Dr. Lynn Holden performed a special valuation of the Videos. Dr. Holden is the Egyptologist who provided the content and advising for *Gates of Horus* (section 3.3, p98).

We had multiple evaluators, so we could merge their results to produce a more stable evaluation. While having two graders is minimal, we really wanted three, so we engaged four. As it happened, we were fortunate to receive full feedback from all four on almost all the tests. The one exception was the video test, where we had three graders, which is acceptable.

Most of the tests and all of the evaluations are conducted online, primarily using a web-based survey hosting service, Survey Monkey (2007). The service has an online survey builder, simple data management, and hosting for as many surveys we needed. It worked reasonably

well, and saved us a great deal of time programming our own online forms and database. However, it was never intended for research of this type, which led to some quirky limitations. Chiefly, we found ourselves having to create a large number of special purpose surveys, many of them referring to a single student for a single test. This will become clearer as we present the tests in this section.

Both the Pretest and Post Test resembled a kind of quiz that one would take in a classroom, and were implemented standard online surveys. As with the typical survey, each test was accessible through the internet via a URL. When the student indicated that s/he was done with the test, Survey Monkey would store the information. At any time, we could download all of the student answers to a single spreadsheet, from anywhere on the Internet. Student confidentiality was protected by the password access to survey monkey and our use of code names. Both the Pretest and Post Test were accessible through shortcuts on the desktop for each of the testing computers, except for the Earth Theater's server. When it was time for student to take one of these tests, the tester would simply double-click on the shortcut to launch the online quiz.

The Follow-Up test is an online quiz, like the Pretest and Post Test. The student took it at home or the library or wherever else s/he had access to a computer. For practical reasons the student took the RPM test, the Presence and Comfort test, and the Drawn Maps, on paper. We copied all of the RPM test scores on to a spreadsheet, but found it more convenient to use a Survey Monkey form to enter all of the presence and comfort test data. We photographed students' Magnet Maps and filmed their Video presentations.

### 3.7.3 Access to the Forms

The graders accessed these individualized Post Test grading forms via an online index we wrote in very simple HTML code. Because there were four graders, we found it convenient to randomly divide the Post Tests into four different groups, each group with an access index, like the one in Figure 33, below. Then we could assign the groups to the graders at different times, keeping them working on different evaluations as much as possible. This was a further hedge against problems which might have resulted in some graders not being able to complete all of the Post Test evaluations. If we had, for example, two different partial sets of evaluations by which to cover all of the Post Tests, that would still have been of some value. As it was, all the graders graded the Post Tests.

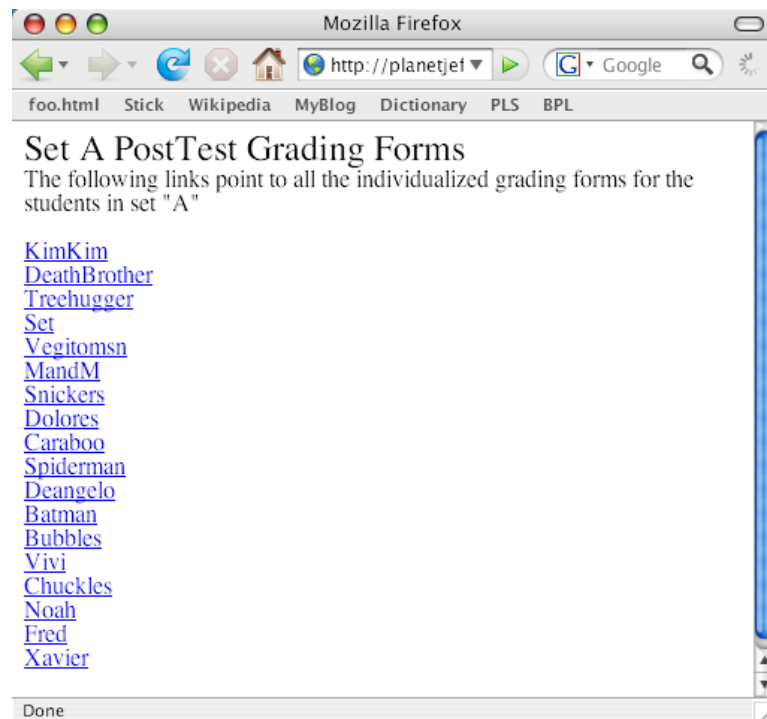

**Figure 33.** Sample Index of Online Grading Forms

As with the Post Tests, we had to make individual evaluation forms for all of the Follow-Up tests, both mapping tests, and the video tests. To keep track of them all, and give the graders active lists to work from, we created the master index in Figure 34.

The screenshot shows a web browser window with the URL <http://publicvr.net/grading/>. The page title is "Grading Matrix for Gates of Horus Study". Below the title is a paragraph: "This is the schedule for grading students' post tests, follow up tests, the videos, hand drawn maps, and magnet maps. Each cell of the table has a link to everything you'll need to complete the task, except for the videos. You will receive the actual videos on a DVD in the mail." The table below is a grid with columns for graders and rows for due dates. Each cell contains a grid of links to individualized tests.

Due Date	Adrienne			Ben			Jane			Kathy		
Done	<a href="#">PostA</a>	<a href="#">PostB</a>		<a href="#">PostD</a>	<a href="#">PostA</a>		<a href="#">PostC</a>	<a href="#">PostD</a>		<a href="#">PostB</a>	<a href="#">PostC</a>	
Done	<a href="#">PostC</a>	<a href="#">PostD</a>	<a href="#">FollowA</a>	<a href="#">PostB</a>	<a href="#">PostC</a>	<a href="#">FollowD</a>	<a href="#">PostA</a>	<a href="#">PostB</a>	<a href="#">FollowC</a>	<a href="#">PostD</a>	<a href="#">PostA</a>	<a href="#">FollowB</a>
Done	<a href="#">FollowB</a>	<a href="#">FollowC</a>	<a href="#">FollowD</a>	<a href="#">FollowA</a>	<a href="#">FollowB</a>	<a href="#">FollowC</a>	<a href="#">FollowD</a>	<a href="#">FollowA</a>	<a href="#">FollowB</a>	<a href="#">FollowC</a>	<a href="#">FollowD</a>	<a href="#">FollowA</a>
May 3rd	<a href="#">DrawnA</a>	<a href="#">DrawnB</a>		<a href="#">DrawnD</a>	<a href="#">DrawnA</a>		<a href="#">DrawnC</a>	<a href="#">DrawnD</a>		<a href="#">DrawnB</a>	<a href="#">DrawnC</a>	
	<a href="#">DrawnC</a>	<a href="#">DrawnD</a>		<a href="#">DrawnB</a>	<a href="#">DrawnC</a>		<a href="#">DrawnA</a>	<a href="#">DrawnB</a>		<a href="#">DrawnD</a>	<a href="#">DrawnA</a>	
May 3rd	<a href="#">MagnetA</a>	<a href="#">MagnetB</a>		<a href="#">MagnetD</a>	<a href="#">MagnetA</a>		<a href="#">MagnetC</a>	<a href="#">MagnetD</a>		<a href="#">MagnetB</a>	<a href="#">MagnetC</a>	
	<a href="#">MagnetC</a>	<a href="#">MagnetD</a>		<a href="#">MagnetB</a>	<a href="#">MagnetC</a>		<a href="#">MagnetA</a>	<a href="#">MagnetB</a>		<a href="#">MagnetD</a>	<a href="#">MagnetA</a>	
summer	<a href="#">VideoA</a>	<a href="#">VideoB</a>		<a href="#">VideoD</a>	<a href="#">VideoA</a>		<a href="#">VideoC</a>	<a href="#">VideoD</a>		<a href="#">VideoB</a>	<a href="#">VideoC</a>	
summer	<a href="#">VideoC</a>	<a href="#">VideoD</a>		<a href="#">VideoB</a>	<a href="#">VideoC</a>		<a href="#">VideoA</a>	<a href="#">VideoB</a>		<a href="#">VideoD</a>	<a href="#">VideoA</a>	

**Figure 34.** The Grading Matrix

As it appears, each cell of the table is an active link to an index of individualized tests, the Grading Matrix. The due dates on the left changed with current circumstances. The ones you see in this example are simply the due dates from the final role update.

Each grader worked through his or her personal list of individualized forms. Note that the forms were individualized by student, but not to the graders as well. For example, Survey Monkey recorded input from all four graders for student “KimKim” in a single spreadsheet. Data analysis required merging the spreadsheets.

### 3.7.4 Data Management

We stored and manipulated all data in Microsoft Excel, which we also used for much of the data analysis. We used SPSS for some of the more advanced statistical analysis. We stored absolutely all files for everything related to this dissertation in SVN, a configuration management and file versioning tool. This allowed us to make incremental changes, save those



versions, and attach specific comments to each incremental change. All files, including the raw, unprocessed data files, are available upon request, as well as the change log files and intermediate versions.

All files pertaining to this dissertation are maintained in a directory tree under SVN management. We refer to files by their full path from the directory root through the actual file name. For example, “/Analysis/Videos/HypothesisTest.xls” refers to the (statistical) hypothesis test performed on data gathered from the “Video” testing (section [5.0 p154](#)). In all files everywhere, each student’s data is referred to by that student’s code name. Some of them are whimsical, but all protect the students’ privacy.

## **3.8 THREATS TO VALIDITY**

This section describes confounding or interfering factors that may pose a risk to a statistically significant outcome or the relevance of the result. We believe that we have mitigated the most likely threats, which are described here, taking care to make the game playable, the user interface usable, the test protocol comfortable, and all three as bug-free as possible. We structured the game itself to naturally resolve (usually) within time limits. We hoped that a field trip to the Museum and playing an Egypt-themed computer game were exciting enough, so the added excitement of using virtual reality would not make much difference in the final results. The design of the Earth Theater mitigated motion sickness. Finally, we mitigated fatigue by allowing students to take a short break at any time and moving them from one activity to another frequently. During pilot testing we eliminated or minimized all of these negative factors.

### **3.8.1 Immersive VR is Engaging Because It Is New.**

At present, Immersive VR applications are rare and usually praised by users as thrilling, fun and exciting. This alone may result in a high level of user engagement, which theoretically could provide a transitory advantage for students in the Theater Group. However, computer games, Egypt, and field trips to the museum are all very popular with this age group. We expected that all of the test subjects would be so excited that the added thrill of visual immersion would not make a measurable difference.

### **3.8.2 Motion Sickness**

Unlike Head Mounted Displays, CAVEs and similar devices provide optic flow in the student's peripheral vision, which may cause motion sickness in some of the subjects (Harris, 1998, 1999; Kennedy, 1992, 1995; Kolanski, 1995; Lin, 2002; Prothero, 1999; Kuno, 1999; Owen, 1998; Howarth, 1998). The most effective way to reduce this problem was to discourage students from moving and turning in the virtual environment any more than necessary.

The panoramic view available in the Earth Theater and the user's ability to control the selection/activation cursor independently reduced the student's need to navigate to see and select objects. Also, the navigation speed in Earth Theater was much slower than in the typical video games to reduce confusion and motion sickness and to convey a sense of the temple's grand scale. Most importantly, audiences see immersive movies in the Earth Theater on a regular basis with very few complaints of motion sickness. While the projection screen in the Earth Theater provides a 210° horizontal field of view, it only provides 30° vertical, which helps the audience feel more physically grounded. During testing, students reported little or no symptoms of motion sickness.

### **3.8.3 Application & Interaction Design**

Success of any VR application depends on the quality of its interaction design. Navigation has to be easy and comfortable, selection straightforward and performance crisp. Many Immersive VR experiments have had major problems as a result of poor interaction design or inadequate technology (Jackson, 2000). Fortunately, the technology has advanced considerably from the time most of those studies were conducted. Also, interaction design for VR applications has continued to improve, yielding some clear design principles (Bowman, 2002). We improved the interface for Gates of Horus during pilot testing to what we hoped was an acceptable level of quality.

### **3.8.4 Limited Quantity of Content**

The content of the learning game (*Gates of Horus*, section 3.3, p98) must be finite for practical reasons. However, if there is too little to learn, it could result in a ceiling effect for learning outcomes, where all students in all treatment groups learn everything. The Pilot Study (section 3.5, p121) showed this unlikely to be a problem.

### **3.8.5 Fixed Learning Time**

For practical reasons, students must have a fixed period of time to explore the temple and learn the associated materials. This runs the risk of forcing a student to stop when s/he is engaged in and learning or to be forced to continue when they wish to stop. That is why, we structured the game, *Gates of Horus* (section 3.3, p98) to complete in a limited period of time. Most students completed the game in approximately 40-80 minutes, which was acceptable for the study,

### **3.8.6 Fatigue**

Testing and treatment took approximately two hours for each subject, which could be tiring. Fortunately, students revealed a remarkable degree of energy and interest from the kids, with none of them asking for a break. We surmise that the variety of activities kept it interesting.

#### 4.0 POST TEST RESULTS (ACCEPTANCE AND EFFECTIVENESS)

Results from the Post Test strongly support **H0** (section 3.4, p119), showing that students found the game, Gates of Horus (section 3.4, p98) enjoyable and useful. Results also supported **H1**, showing that students in the Theater Group and the Desktop Group scored far better on the Post Test than those in the Control Group. This shows the stability and effectiveness of the learning game and of the VR interface. The result also gives us a basis for further comparisons of immersive and non-immersive interfaces using the game.

In this chapter, we will first present data for the affective questions (**H0**) on the Post Test and the results. Then, we will list the questions asked on the Post Test and show which questions produced results on which our graders could agree well enough for further analysis. Finally, we compare the learning results among the experimental groups (**H1**) to demonstrate that students who play the game really learned something.

However, comparing the Desktop and the Theater Groups produced no significant differences we can trust (for **H2**). We believe this is because our Post Test is not sensitive to deeper learning, instead resembling a standard quiz for factual knowledge. Students are very experienced with tests of this type and make good use of the scaffolding questions they provide. That said, it might be possible to detect the learning result this way, if our population size were larger. While it was important that we have a test of this kind to maintain consistency with common practice, the Video Test proved more fruitful (section 5.0 p154).

## 4.1 ACCEPTANCE

The first part of the Post Test questionnaire asks the student to rate their satisfaction with the learning game. Student acceptance is very important to any learning activity, being a crucial determinant of engagement. One of the main justifications for educational gaming is the hope that students will accept it with at least some of the enthusiasm they show for games of similar complexity (section 2.4.6, p38). Fortunately, the students in our study reported that they found Gates of Horus (section 3.3, p98) enjoyable and useful. Table 3 and Figure 35 summarize the raw results. This satisfies experimental hypothesis **H0** (section 3.4, p119).

**Table 3:** Affective Questions and Raw Results

	Yes, Totally!	Yes	Maybe	No	Absolutely Not!
Did you have fun playing the game?	12	26	3	0	1
Would you recommend Gates of Horus to your friends?	8	18	14	2	0
Did you learn something?	19	23	1	0	0
Are you glad you learned what you did learn?	14	25	4	1	0
Are you glad you played the game?	19	17	3	2	1
Would you like to play another game like it?	18	19	5	0	1
Do you want to learn more about ancient Egypt?	13	18	10	1	0

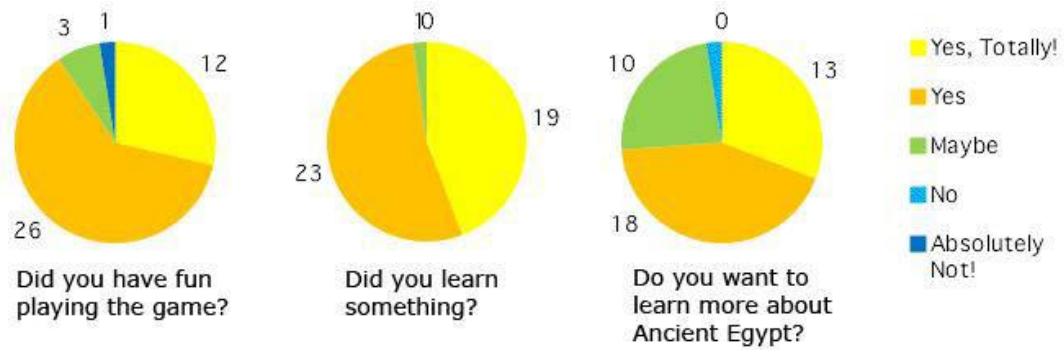

**Figure 35.** Key Affective Results

As impressive as these reports are, the most important indicator of student acceptance is that nearly all students played the game from beginning to end, 45 minutes to one hour, without even asking for a break.

However, comparing affective results from the Desktop and Theater Groups showed no significant difference. In this case, we were able to use the T-TEST, two-tailed, uneven samples to produce the P-values in Table 4, below. This was possible, because the students provided their answers on a five-level Likert scale and the results were sufficiently close to a normal distribution for a parametric test (Jaccard, 1996). We believe the lack of a clear difference between the two groups' affective scores is a result of our efforts to reduce the effect of the raw novelty of VR (3.8.1, p133). With the excitement of a day at the Museum, playing a learning game, and the popularity of Egypt, we had hoped to stimulate students in both groups to experience as similar an excitement level as possible. It is possible that we have succeeded, but our experiments are not structured to assess that.

**Table 4.** Affective Questions

Question	Short Name	D v T	
Did you have fun playing the game?	fun	0.1028	+
Would you recommend <i>Gates of Horus</i> to your friends?	commend	0.3456	+
Did you learn something?	learn	0.2325	+
Are you glad you learned what you did learn?	gladlearn	0.1171	+
Are you glad you played the game?	gladplay	0.2625	+
Would you like to play another game like it?	another	0.4055	+
Do you want to learn more about ancient Egypt?	learnmore	0.1966	+
Affect Average	aave	0.0904	+

## 4.2 QUESTIONS IN THE POST TEST

The Post Test measures at the *factual* level of learning (Bloom 1957). Factual questions (usually multiple-choice formats) quiz the student on the most basic physical features of the temple itself. Examples include “How many gates does the temple have?” and “Where were the big hawk statues?” Conceptual questions often repeat the questions asked by the priests by the gateways, but in a different form. For example, two or three yes/no questions may be condensed into a single multiple-choice question or a question may be reworded. Conceptual questions are those which were not asked by the priest, but which follow the same criteria. Some are corollary to the priests' questions, but others are not. Some questions require written answers, with just one or two sentences needed and not more than a paragraph allowed.

Table 5, below, lists all questions in the Post Test. Multiple-choice questions, such as Q11 and Q15 have the answer options listed to their right. Open-ended questions are indicated as such in the second column. Question 2 presents the student with a matrix where s/he gives one of five responses to each of the sub-questions. See (Appendix A, p287) for a reproduction of the test.



**Table 5.** Questions from the Post Test

Q1. What is your code name?	(open ended)			
Q2. For each of the following questions, please check the box which best matches your answer. (Absolutely not, no, maybe, yes, yes Totally!)	Did you have fun playing the game?	Would you recommend Gates of Horus to your friends?	Did you learn something?	Are you glad you learned what you did learn?
	Are you glad you played the game?	Would you like to play another game like it?	Do you want to learn more about ancient Egypt?	
Q3. What was the important symbol above all of the doorways in the temple? (choose one)	Son of the Sun	Hawk God	Winged Disk	Double Crown of Egypt
Q4. The great, big, front of the temple was called the (choose one)	Horus	Gate	Pylon	Mountains
Q5. Like many of the real temple ruins in Egypt, most of our temple does not have much color. Why? (choose one)	It's supposed to be that way	Over the centuries, the colors were worn away.	Somebody in the 20th century spray-painted all the ruins with the sandy/gold color you see.	
Q6. What was the important symbol above all of the doorways in the temple? _____.	(open ended)			
Q7. Who or what gives Pharaoh the authority to defeat the enemies of Egypt, according to the ancient Egyptians? (choose one)	The people of Egypt	The rich nobility	The Egyptian army	The Gods
Q8. When Pharaoh went before the gods with his offerings, who was he representing? Whose interests was he looking out for? (choose one)	The Egyptian people	himself	the nobility	
Q9. Very important festivals took place in the Courtyard of the temple. Who went to these festivals? (choose one)	the workers and the lower classes	everybody	the nobility	pharaoh and the priests

Q10. How could an Egyptian get a statue representing their ancestors placed permanently in the Hypostyle Hall of the Temple? (choose one)	making a large donation to the temple	by sneaking it in	by being a noble or member of the upper classes	by wearing a very large silly hat
Q11. Suppose you ask any ancient Egyptian "where did the world begin?" They will answer (choose one)	the very place where our temple is built, right in our town	where the great temple at Karnak is now built	I don't know	
Q12. Did the roof of the Hypostyle Hall have square holes in the ceiling? (choose one)	yes	no		
Q13. What happened in the Hypostyle Hall? (select all that apply)	eating and Drinking	quiet meditation	People honored the god Horus.	People honored their ancestors
Q14. What did Pharaoh do in the Sanctuary? (check all that apply)	Worshiped his ancestors.	Fed the god.	Rested.	Represented the people of Egypt.
Q15. The Shrine in the Sanctuary was (Select all that apply:)	A magical gateway to heaven.	The place where the sacred image (statue) of the god stood.	The point from which the blessings of would flow outward to the land of Egypt.	
Q16. What does the Pylon tell us about how the Egyptians wanted the world to be like?	(open ended)			
Q17. What did people do in the Courtyard?	(open ended)			
Q18. What happened in the Hypostyle Hall?	(open ended)			
Q19. What did Pharaoh do in the Sanctuary? How did the Sanctuary compare with the rest of the temple?	(open ended)			
Q20. Tell us one thing you learned from playing with the temple.	(open ended)			

### 4.3 GRADING THE OPEN-ENDED QUESTIONS

While multiple-choice questions can be scored automatically, the short answer questions require human judgment. To report his or her judgment on a student's short-answer questions, the grader filled out the online Post Test Grading Form for that student. Table 6, p143, lists the questions on that form. Note that most questions have a series of facts following, for each of which the grader assigns a rating. The available ratings for a question are listed after the question itself in the same cell.

Many of the questions have "Other1" and "Other2" listed as options. Each one is a wildcard for the grader to use to give a point score for some fact that is relevant to the question but did not appear as a choice. The grader does not indicate what that fact is. While this information from the grading of the wildcard is interesting, the way the Post Test Grading Form asks for it has proven to be problematic in data analysis. See Appendix D, p345, for a reproduction of the Post-Test Grading Form.

**Table 6:** Grader's form for scoring open-ended questions

Grader Name _____					
<b>Q2.</b> What was the important symbol above all of the doorways in the temple? _____ . (none, half, full)					
<b>Q3.</b> What does the Pylon tell us about how the Egyptians wanted the world to be like? (none, half, full)	Orderly	Ruled by Egypt	Pharaoh rules Egypt		
	Pharaoh has the support of the gods	Other1	Other2		
<b>Q4.</b> What did people do in the Courtyard? (none, half, full)	Had great public festivals for everyone	Dressed simply to show their humility before the gods	Brought their best things as offerings	Gave thanks to the gods as a community	
	Saw the god and pharaoh (symbolically) embrace in a public way	Saw the connection between heaven and earth symbolized by the open sky of the Courtyard	Saw how Pharaoh made offerings to the gods on behalf of the people.	Other1	Other2
<b>Q5.</b> What happened in the Hypostyle Hall? (none, half, full)	People made a private connection with the divine.	People honored their ancestors.	People saw the connection to the beginning times through the planet-form columns.	Other1	Other2
<b>Q6.</b> What did Pharaoh do in the Sanctuary? How did the Sanctuary compare with the rest of the temple? (none, half, full)	Communicates with the gods.	Makes offerings to the gods.	Entreats the god to let the blessings of heaven flow to the land of Egypt.	Represents the community.	
	Stands on the ground with the world began	Other1	Other2		
<b>Q7.</b> Tell us one thing you learned from playing with the temple. (low, average, high, N/A)	importance	relevance	generality		
<b>Q8.</b> Please rate these aspects of The student's performance (strongly disagree, disagree, neutral, agree, strongly agree)	strongly disagree	disagree	neutral	agree	strongly agree
<b>Q9.</b> Please add any additional comments you have regarding student's answers to these questions. Are there any additional concepts that the student entered? Is there a pattern to the student's answers which are not captured by the grading scheme above?					

#### 4.4 INTERRATER RELIABILITY ANALYSIS

Four different graders (Baker, Bruckner, Getkin, and Vadnal) evaluated students' answers to the short-answer questions in the Post Test. This gives us four ratings for each fact the student was supposed to master, and our goal is to average all four into a single rating for further analysis. For each grade, this average gives us a more stable measure, less influenced by who the graders are. However, we cannot simply accept a simple average because we could create a reasonable looking average from wildly disparate (and therefore meaningless) grader scores. To determine whether there *is* sufficient agreement for an average to be valid, we use the same method of Interrater Reliability Analysis (IRR) we employ for the Video Test. See section 5.3, p163.

Part of this process is to recode the grader responses into numbers, because it is more convenient. In the Post Test, we made the following substitutions:

- Simple, factual questions: none → 0, half →0.5, full →1.0
- "Tell us one thing you learned from playing with the Temple.": N/A →0, low →0.33, average →0.66, high →1
- The four questions under: "Please rate these aspects of the student's performance": N/A →0, strongly disagree →0, disagree →0.25, neutral →0.05, agree →0.75, strongly agree →1.

Table 7, shows results of the IRR analysis on grades for the short-answer questions in the Post Test. The first column shows the individual questions. The second column shows all of the facts associated with each question. The third column shows the short name or codename for each

concept. For each student and for each fact, each grader assigns a score depending on how well the grader thought the student showed knowledge of the fact in his or her answer to the open-ended question. The fourth column shows the IRR calculation's P-values for graders' agreement on each fact. If  $P > 0.05$  for any fact, there is significant disagreement among the graders, so we will exclude data for that fact from further analysis. Finally, the fifth column shows the total number of points awarded by all graders to all answers for each fact.

**Table 7.** Short-Answer Questions Interrater Reliability for the Post Test

<b>Question</b>	<b>Facts the grader looked for in the student's answer .</b>	<b>Short Name</b>	<b>Fleiss Kappa P-value</b>	<b>Point Totals</b>
What was the important symbol above all of the doorways in the temple?	The Winged Disk.	pdisk	0	170.5
What does the Pylon tell us about how the Egyptians wanted the world to be like?	Orderly	porder	0	72.5
	Ruled by Egypt	pruled	0.0001	42.5
	Pharaoh rules Egypt	ppharaoh	0.0315	16.5
	Pharaoh has the support of the gods	psupport	0.2502	16
	Other1	pothier1	0.1173	54
	Other2	pothier2	0.8781	10
What did people do in the Courtyard?	Had great public festivals for everyone	cfest	0	144.5
	Dressed simply to show their humility before the gods	chumility	0	27
	Brought their best things as offerings	cbest	0	55.5
	Gave thanks to the gods as a community	cthanks	0.1144	51
	Saw the god and Pharaoh (symbolically) embrace in a public way	cembrace	0.7038	4
	Saw the connection between heaven and earth symbolized by the open sky of the Courtyard	csky	0.1288	2.5
	Saw how Pharaoh made offerings to the gods on behalf of the people.	cofferings	0.7585	6.5
	Other1	cother1	0.9985	28.5
	Other2	cother2		0

Question	Facts the grader looked for in the student's answer .	Short Name	Fleiss Kappa P-value	Point Totals
What happened in the Hypostyle Hall?	People made a private connection with the divine.	hdivine	0	78.5
	People honored their ancestors.	hancestors	0	165.5
	people saw the connection to the beginning times through the planet-form columns.	hcolumns	0.904	3.5
	Other1	hothier1	0	71
	Other2	hothier2	0.922	7.5
What did Pharaoh do in the Sanctuary? How did the Sanctuary compare with the rest of the temple?	Communicates with the gods.	sgods	0	130
	Makes offerings to the gods.	sofferings	0	89
	Entreats the god to let the blessings of heaven flow to the land of Egypt.	s blessings	0.0001	55
	Represents the community.	srepresent	0.0007	46.5
	Stands on the ground where the world began	sground	0.0095	10.5
	Other1	s other1	0	97.5
	Other2	s other2	0.548	15
Tell us one thing you learned from playing with the temple.	importance	limport	0	135.76
	relevance	lrelevant	0	129.7
	generality	lgeneral	0	132.84
Please rate these aspects of The student's performance	Student is integrating knowledge from school or elsewhere into his or her answers.	integrate	0.5732	73.75
	Student is making interesting connections between facts showing a higher level learning.	connection	0.001	103
	Student is doing a good job of reciting the facts of the temple.	roterecall	0	128.5
	Student has made references to the way that temple, or parts of it, actually look.	references	0.091	64.5



Table 7, above, shows that data for a fairly large number of ratings had to be eliminated from consideration. However, they account for only 13.07% of total points awarded. We also eliminated the three “other” columns from further analysis, because that data is problematic (section 4.3, p142).

## 4.5 HYPOTHESIS TESTS

Table 8, below, shows the results of comparing student performance among the three treatment groups. We refer to each rated fact by its short name in the first column. In column “C vs D,” each number refers to the error P-value of the Mann-Whitney comparison between grades for students in the Control Group versus grades for students in the Desktop Group, for the corresponding fact.

Each P-value represents the probability that the observed difference between the compared groups of grades resulted from random chance. The third column shows the polarity or direction of the comparison. For example, the “+” in row “pdisk” under column “C vs D” indicates that the *average* grade for students in the Desktop Group for this fact is *higher* than the average grade for students in the Control Group for this fact. Notice how the polarity for all comparisons where the P-value is less than 0.1 always positive. P-values less than 0.1 are shown in boldface type.

Column “C vs T” compares the Control Group with a Theater Group, and column “D vs T” compares results from the Desktop Group versus the Theater Group. The last column shows the total number of points awarded by all graders to all students for each rating. Facts are clustered, with an overall comparison for the whole cluster appearing at the bottom of the cluster. This is *not* a simple average of the utilities in the cluster. Instead, each cluster P-value is based on an average of the *original data* for all ratings in the row. “grandave” below all 4 clusters is based on an average of all ratings that appear in the table above it.

**Table 8.** Comparison of Learning from the Post Test Short Answer Questions

Shortname	C vs D		C vs T		D vs T		Total Points
pdisk	<b>0.0056</b>	+	<b>0.0022</b>	+	0.7100	+	170.5
porder	0.4098	+	<b>0.0158</b>	+	0.5226	+	72.5
pruled	0.0392	+	<b>0.0100</b>	+	0.5752	+	42.5
ppharaoh	0.2739	+	0.3047	+	0.7369	-	16.5
pave	<b>0.0025</b>	+	<b>0.0002</b>	+	0.2995	+	
cfest	0.7175	+	0.1162	+	0.6162	+	144.5
chumility	0.2308	+	<b>0.0596</b>	+	0.8189	+	27.0
cbest	<b>0.0064</b>	+	<b>0.0125</b>	+	<b>0.0528</b>	+	55.5
cave	<b>0.0326</b>	+	<b>0.0005</b>	+	0.3967	+	
hdivine	0.5417	-	0.3589	+	0.7136	+	78.5
hancestors	0.0137	+	<b>0.0001</b>	+	<b>0.0421</b>	+	165.5
have	<b>0.0090</b>	+	<b>0.0002</b>	+	0.4428	+	
sgods	0.5226	+	<b>0.0930</b>	+	0.4258	+	130.0
sofferings	0.9941	-	0.1247	+	0.6407	+	89.0
s blessings	0.1478	+	0.1118	+	0.9628	+	55.0
srepresent	0.7429	+	<b>0.0490</b>	+	0.5979	+	46.5
sground	0.4872	+	0.2468	+	<b>0.0485</b>	+	10.5
save	0.1946	+	<b>0.0068</b>	+	0.5029	+	
grandave	0.0064	+	<b>0.0000</b>	+	0.6712	+	
limport	<b>0.0000</b>	+	<b>0.0000</b>	+	0.4582	+	135.8
lrelevant	<b>0.0000</b>	+	<b>0.0000</b>	+	0.9116	+	129.7
lgeneral	<b>0.0000</b>	+	<b>0.0000</b>	+	0.1759	-	132.8
lave	<b>0.0000</b>	+	<b>0.0000</b>	+	0.8388	+	
connection	<b>0.0011</b>	+	<b>0.0002</b>	+	0.9581	+	103.0
rotrecall	<b>0.0003</b>	+	<b>0.0000</b>	+	0.6865	+	128.5

You will notice that the large number of P-values under “C vs. D” and “C vs. T” show the Control Group performing considerably worse than the other groups. This is what we would expect because members of the Control Group simply took the pretest before any exposure to the educational materials. They had to depend upon previous knowledge and test-taking techniques. We compare results for Desktop and Theater Groups separately, to make sure that the VR interface for the Theater Group is not a problem. Finally, it is important that when we asked the graders to produce more general judgments of student performance, shown in the rows below “grandave” in Table 8, the P-values became very low.

When we compare the results in the two columns, it looks like the Theater Group gained a wider lead over the Control Group than did the Desktop Group. However, the direct comparison between the Theater and Desktop Groups in column “D vs. T” does not show a convincing difference in performance. Only three facts have values below 0.1, and none of the aggregate scores do.

Similar to Table 8, results for the multiple-choice questions in

Table 9, show (1) the Theater Group had a clear advantage over the Control Group, (2) the Desktop Group had a weaker but still-visible advantage over the Control Group, and (3) the results were inconclusive for the Desktop versus Theater Group comparison. In all three columns, the comparison score for the averaged data in row “grandave” show a solidly significant difference. This appears paradoxical in the “D vs. T” column—a clear example of why an average or total, by itself, cannot be trusted. The other two averages are believable, because enough of the component data shows significant or nearly significant difference. This satisfies experimental hypothesis **H1** (section 3.4, p119).

Given how high all of the other P-values are it is not clear that testing a larger group of students would make much difference. We believe that asking students factual questions about the Temple is not the appropriate method to measure the learning effects of visual immersion with this material (Dede, 2007).

**Table 9.** Hypothesis Results from the Post Test  
(Multiple-Choice Questions)

Question	C vs D		C vs. T		D vs. T	
overdoor	<b>0.0036</b>	+	<b>0.0010</b>	+	1.0000	
bigfront	<b>0.0536</b>	+	<b>0.0337</b>	+	1.0000	
color	0.1818	+	<b>0.0741</b>	+	1.0000	
authority	1.0000		1.0000		1.0000	
represent	0.2733	+	<b>0.0146</b>	+	0.3087	+
festivals	<b>0.0001</b>	+	<b>0.0001</b>	+	1.0000	
statues	<b>0.0038</b>	+	<b>0.0001</b>	+	0.7095	+
genesis	0.5145	+	<b>0.0188</b>	+	0.2604	+
square	0.3416	+	<b>0.0325</b>	+	0.4444	+
eating	1.0000		0.6423	+	1.0000	
meditating	0.1110	-	0.7551	+	<b>0.0169</b>	+
honorhorus	0.3203	-	1.0000		0.2047	+
ancestors	0.6614	+	0.3830	+	1.0000	
worship	1.0000		0.5503	-	0.3666	-
feedhorus	0.5145	-	0.5370	-	1.0000	
rested	<b>0.0436</b>	+	0.0567	+	1.0000	
thepeople	0.2003	+	<b>0.0032</b>	+	0.2604	+
heaven	0.5145	+	<b>0.0010</b>	+	0.0271	+
image	1.0000		1.0000		1.0000	
blessings	0.5006	-	1.0000		0.3357	+
grandave	<b>0.0000</b>	+	<b>0.0020</b>	+	<b>0.0290</b>	+

## 4.6 COMPARE WITH RPM RESULTS

Comparisons that involve students' scores on Raven's Progressive Matrices (section 5.6, p188) essentially showed nothing. In

Table 10, below, only two (Mann-Whitney error) P-values were below 0.1, which is probably a random result. In hindsight, we surmise that because Raven's Progressive Matrices is a measure of each student's visual reasoning ability, it would have only a secondary effect on factual recall. If RPM scores are correlated with better performance, and there is no guarantee of that, our sample size is much too small to detect it.

**Table 10.** Post Test **H1** Comparison Crossed with RPM Results.

LowRPM( D vs. T )	HighRPM( D vs. T )	LowRPM vs. HighRPM in D&T
0.9029	0.9303	1.0000
0.1895	0.2127	0.7841
0.5920	1.0000	0.5072
0.7925	0.7214	1.0000
0.4911	0.4328	0.5194
0.1092	0.5193	0.1081
0.7926	1.0000	0.5217
0.9338	0.9100	<b>0.0139</b>
0.1649	0.4679	0.7413
0.5810	0.8079	0.9233
<b>0.0213</b>	0.3067	<b>0.0843</b>
0.0533	0.8161	0.4643
0.1995	0.3590	0.8088
0.1308	0.6513	0.8475
0.9076	0.2698	0.3718
0.1339	0.3034	0.7741
0.8212	0.4737	0.2174
0.1395	0.2695	0.9661
0.1167	0.7524	0.9886
0.7122	0.1469	0.7220
0.6128	0.4896	0.6576
0.2303	0.7527	0.1184
0.6878	0.5408	0.4504
0.3231	0.9843	0.8540
0.3523	0.7831	0.4999

## 5.0 VIDEO TEST RESULTS (IMMERSION HELPS)

Each student produced a documentary video. First, three human graders evaluated the video for factual knowledge, and their judgments were combined to produce a final score. Our most important result was a significant difference between the *Video Test* results from the Theater Group and results for the other two groups combined. Figure 51 shows the stages of our testing sequence relevant to the Video Test and its main results. We included the Video Test scores from the Control Group, after they had played the game, because we did not think that the order of the Post Test and the game would make a substantial difference in their overall learning.

Next, our Egyptologist, Dr. Lynn Holden, evaluated each student's video for the student's mastery of factual knowledge about the temple. Here, the difference in learning with visual immersion versus non-immersion was statistically much stronger. Not only were the main results for the conceptual and factual measures in accord, but they also tended to parallel each other in the individual measures. For every concept where the Theater Group statistically did better than the others, there was at least one fact related to that concept where the Theater Group *also* did better. We are confident that this data satisfies **H2**.

Finally, we found some evidence that students with low visual reasoning skills, as measured by Raven's Progressive Matrices test section 5.6, p188, had more to gain from using visual immersion than those with better visual skills. This supports **H6**, and is worth comparing to Winn's (1997) findings.



## 5.1 DESCRIPTION

For each video test, the tester took the student to a room containing a desktop computer, a projector, and a video camera, as shown in Figure 36, below.

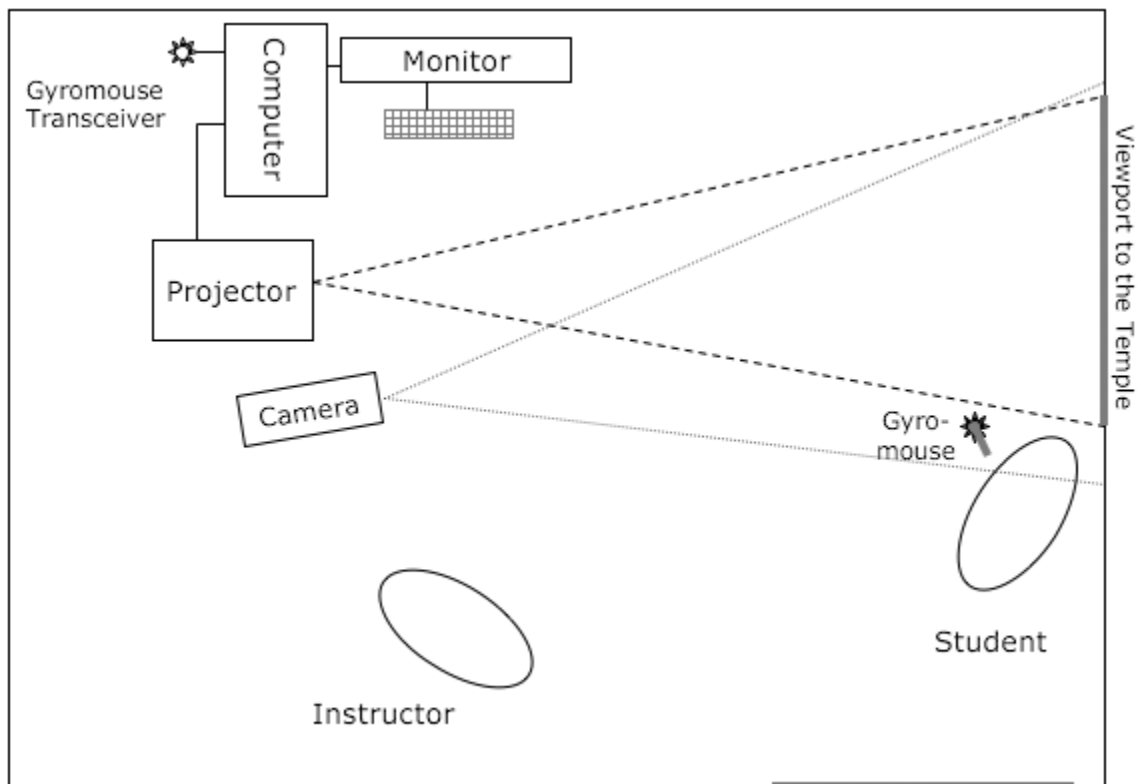

**Figure 36.** Video Test Setup

The computer was running a non-interactive version of *Gates of Horus* (section 3.3.1, p99). The software presented a doors-removed silent copy of the Virtual Egyptian Temple from the game, with no selection cursor available. However, the student could still use the Gyromouse to navigate the temple just as in the game. The temple was visible in the computer's monitor, while the projector duplicated that view in a projection on the opposite wall.

The tester restarted everything and positioned the user view to show the front of the temple, similar to where the student started in the Pylon section of the game (Figure 26, p110). Next, the tester instructed the student to produce a guided tour of the Temple, saying in effect “Tell us everything you know about the Temple, and show us as you tell us.” The student was informed that his or her guided tour would be recorded, with one copy to stay in confidence with the testers. We also informed each student that s/he would receive a personal copy (a DVD) of the recording, if s/he completed the Follow-Up tests. When the student was ready, the tester would begin recording both the student and the computer screen with a digital video camera while the students made the presentation. See Figure 37.



**Figure 37.** Student (shown in silhouette) giving a tour of the temple.

A tour took approximately 15 minutes to produce, which we had discovered during pilot testing. The student used the Gyromouse to navigate and could choose a variety of methods to indicate features of the Temple. The student could point with his or her free hand, or with the hand holding the Gyromouse, or with a laser pointer. Also, the student could face the screen, or face the camera most of the time, sometimes using the monitor on desktop to help with navigation. While some presentation styles may have been more demanding than others, the distribution of presentation strategies was essentially random with respect to our experimental conditions. We believe that letting each student use whatever presentation style s/he was most comfortable with was the best way to elicit that student's knowledge with minimum interference from the testing process. In their "tours" the students revealed:

- **factual** knowledge of the temple
- knowledge of **concepts** related to the temple and Egyptian culture
- **ways of thinking** about of the temple
- other **related ideas** and knowledge they may have learned from other sources
- **attitudes** and preferences toward the temple

An advantage of this test was the lack of interference from written test questions. Obviously, this favored students who were extroverted, verbal, or both. For this reason, the video test makes a good companion to the more traditional written tests, which favor students who write well and which do not require social contact by the student during the testing process..

Furthermore, the game itself is also purely visual and verbal, and students performed the video test after the game with no intervening written test. This approach has the potential to provide insight into the abilities and preferences of students who have trouble with written media. Unlike some proponents of using VR for education, we do **not** believe that VR is inherently superior to word-based media for learning, but that it is merely a different tool.

## 5.2 GRADING

To evaluate a student's video, the grader viewed it at least once and answered questions on the Video Grading Form via Survey Monkey. The form asked whether and how well the student grasped a large number of specific ideas, concepts, and facts. The grading form was separated by area to reduce the grader's workload. The grader was free to go forward and backward through the video while making grading decisions.

The screenshot shows a web browser window with the title 'Renee Video'. The address bar shows 'https://www.surveymonkey.co...'. The browser tabs include 'foo.html', 'Stick', 'Wikipedia', 'MyBlog', 'Dictionary', 'PLS', 'BPL', 'Links Related t...', 'Intercoder Reli...', 'PA 765: Data L...', and 'Renee Video'. The main content area is titled 'Renee Video' and has a sub-header '3. Courtyard'. Below this is a question: '8. REMEMBERING FACTS: Evaluate the extent to which the student repeats or paraphrase what the priest told him/her as well as facts which should be apparent from the appearance of certain features of the temple? Indicate for each fact.' The question is followed by a table with three columns: 'none', 'half', and 'full'. The table contains four rows of facts, each with a radio button in the corresponding column. The first row has a checked radio button under 'none'. The second row has a checked radio button under 'full'. The third row has a checked radio button under 'half'. The fourth row has radio buttons under 'none', 'half', and 'full'. At the bottom of the browser window, there is a search bar with 'kappa' entered, and buttons for 'Next', 'Previous', 'Highlight all', and 'Match case'. The status bar shows 'Done' and 'www.surveymonkey.com'.

	none	half	full
The courtyard holds several hundred.	<input checked="" type="radio"/>	<input type="radio"/>	<input type="radio"/>
Everybody could come there from, Farmer to Pharaoh	<input type="radio"/>	<input type="radio"/>	<input checked="" type="radio"/>
Open and undivided.	<input type="radio"/>	<input checked="" type="radio"/>	<input type="radio"/>
made for large religious celebrations.	<input type="radio"/>	<input type="radio"/>	<input type="radio"/>

Figure 38. Sample Page From the Video Grading Form

Table 11, below, lists all questions which the grader answered after or during seeing a student video. Questions 3, 4, 9, 8, 13, 14, 18, and 19 each contains a list of statements; the grader checks a box indicating how much credit the grader wants to give the student for knowing a particular fact. For a reproduction of the grading form, see (Appendix A, p272).

**Table 11.** Video Grading Form Questions

<b>Q1.</b> Grader Name (open ended)
<b>Q2.</b> Is the sound quality too poor to grade this video? (checkbox)
<b>PYLON</b>
<b>Q3. REMEMBERING FACTS:</b> Evaluate the extent to which the student repeats or paraphrases what the priest told him/her as well as facts which should be apparent from the appearance of certain features of the temple. Indicate for each fact. (none, half, full)
The temple is well ordered
the Pylon is a symbol of what Egypt could be
the Pylon is the most massive part of the temple.
the Pylon was colorful.
the colors of the Pylon had been worn away over time.
the Pylon represents the mountains on either side of the Nile.
Pharaoh is shown defeating the enemies of Egypt
the god grants Pharaoh his authority
a sword represents the authority that the god gives to Pharaoh
This temple is dedicated to the god Horus
the hawk statues represent Horus
Horus protects Pharaoh
the statue of Pharaoh beneath the hawk's breast shows that the god protects him.
Horus represents all gods
Pharaoh is the link between the people and the gods
Pharaoh and the gods are united for the good of the world
Horus is the god of Kingship
the hawk is the symbol of Horus
The winged disk is a symbol of unity and protection
the winged disk represents the divine life-force
the winged disk is a symbol of the world
the winged disk represents creation
the winged disk represents life
and a scepter represents protection
<b>Q4. GOAL CONCEPT(s):</b> The student is expected to infer these ideas from the facts. (none, half, full)
The Egyptians thought that the world was orderly.
The Egyptians thought the world was centered on Egypt and its gods.
<b>Q5. EXTRA:</b> Did the students make any TRUE statements about the Pylon which do NOT appear in the previous two questions? Please list. (open ended)

<b>Q6. MISTAKES:</b> How many incorrect or glaringly false statements did the student make? (one, two, three)
<b>Q7. COMMENTS:</b> please add anything you want to say about the student's performance in this area of the temple. (open ended)
<b>COURTYARD</b>
<b>Q8. REMEMBERING FACTS:</b> Evaluate the extent to which the student repeats or paraphrase what the priest told him/her as well as facts which should be apparent from the appearance of certain features of the temple? Indicate for each fact. (none, half, full)
The Courtyard holds several hundred.
Everybody could come there, from farmer to Pharaoh
Open and undivided.
made for large religious celebrations.
The celebrations were joyous.
The joy of the celebrations showed people's gratitude to the gods.
everyone offered their best things at the celebrations
Everyone came wearing simple garments to show their humility before the gods.
The open sky indicates the connection between heaven and earth.
The sun represents the creator god, Amon.
All Egypt was (supposed to be) united under the sun.
The offering scene mural shows Pharaoh giving "every good thing" to the god
The offering scene mural shows the god blessing the King and Egypt with life and prosperity.
On the pillar, the Pharaoh and Horus embrace.
On the pillar, Horus represents the gods and the natural world
On the pillar, Horus and Pharaoh embracing represents the gods and humanity coming together
<b>Q9. GOAL CONCEPT(s):</b> The student is expected to infer these ideas from the facts. (none, half, high)
The people gave thanks to the gods as a community.
<b>Q10. EXTRA:</b> Did the students make any TRUE statements about the Pylon which do NOT appear in the previous two questions? Please list. (open ended)
<b>Q11. MISTAKES:</b> How many incorrect or glaringly false statements did the student make? (one, two, three, four, five+)
<b>Q12. COMMENTS:</b> please add anything you want to say about the students' performance in this area of the temple. (open ended)
<b>HYPOSTYLE HALL</b>
<b>Q13. REMEMBERING FACTS:</b> Evaluate the extent to which the student repeats or paraphrase what the priest told him/her as well as facts which should be apparent from the appearance of certain features of the temple? Indicate for each fact. (none, half, full)
the hall is a quiet and private place
the hall is built on a grand scale to let you know it is sacred
only the literate class could come here
they honored their ancestors here
by honoring their ancestors they connected with heaven
They made offerings to their ancestors
the offerings were placed before statues of their ancestors

anyone could have an ancestor statue at work or at home
if you made a big donation to the temple you could have an ancestor statue tonight the hall.
the columns represent the primeval marsh.
the marsh surrounded the first mound of land
the first land rose from the waters at the beginning of time
The hawks on the ceiling are spirit guides
the hawks guide you deeper into the temple
the hawks show the connection between heaven and earth
<b>Q14. GOAL CONCEPT(s):</b> The student is expected to infer these ideas from the facts. (none, half, high)
The Hypostyle Hall is an intimate space.
The Hypostyle Hall provides the worshiper a private connection to the divine.
<b>Q15. EXTRA:</b> Did the students make any TRUE statements about the Pylon which do NOT appear in the previous two questions? Please list. (open ended)
<b>Q16. MISTAKES:</b> How many incorrect or glaringly false statements did the student make? (one, two, three, four, five+)
<b>Q17. COMMENTS:</b> please add anything you want to say about the students' performance in this area of the temple. (open ended)
<b>SANCTUARY</b>
<b>Q18. REMEMBERING FACTS:</b> Evaluate the extent to which the student repeats or paraphrase what the priest told him/her as well as facts which should be apparent from the appearance of certain features of the temple? Indicate for each fact. (none, half, full)
the Sanctuary is the most important part of the temple
the Sanctuary has the best decorations
everything there is made of the best materials
the most important ceremonies happened there
the ground under the Sanctuary was the very first part of the world.
Time began here.
Every Egyptian town from the world again under their particular temple.
The divine image of Horus stands in the shrine.
Horus represents all gods.
At times, the spirit of the God inhabits the divine image.
If the god was pleased, he would make good things happen for the community, such as a good harvest.
The shrine was the gateway to heaven.
The blessings of heaven flow from the shrine, through the temple, and on to Egypt.
Pharaoh makes the blessings of heaven flow, by conducting the proper ceremonies correctly.
The high priest could act in Pharaoh's place.
<b>Q19. GOAL CONCEPT(s):</b> The student is expected to infer these ideas from the facts. (none, half, full)
Pharaoh communicates with the gods
here, Pharaoh brings down the blessings of heaven by honoring the gods
<b>Q20. EXTRA:</b> Did the students make any TRUE statements about the Pylon which do NOT appear in the previous two questions? Please list. (open ended)
<b>Q21. MISTAKES:</b> How many incorrect or glaringly false statements did the student make? (one, two, three, four,

five+)
<b>Q22.</b> COMMENTS: please add anything you want to say about the students' performance in this area of the temple. (open ended)
<b>FINAL QUESTION</b>
<b>Q23.</b> Is there anything else you want to say about the students' performance in their video? Did they seem to understand what they were talking about? Did they make interesting connections between facts? Did they display knowledge of this league learn from other sources besides the learning-game? (open-ended).



### 5.3 INTERRATER RELIABILITY ANALYSIS

Three graders evaluated the student-made videos using the Video Grading Form (Appendix A, p272). A great deal of research in the social sciences depends upon having multiple raters (graders in our case) evaluate the same phenomena, each one assigning it a score or number. The next step is to aggregate the grader scores into a single rating (grade) which is more stable and accurate than judgments by any one person. We had three raters, Getkin, Bruckner, and Vadnal, assign point values to specific elements of the video. On the grading form, the grader assigned a point score to indicate the degree to which the student evidenced knowledge of a particular fact. Points were awarded on the three-level Likert scale for each fact, with three choices: “none,” “half” and “full.” Resulting data for a single fact looked like Table 12, below.

However, combining graders’ assessments must be done with care. Otherwise the final score may be uninformative or (worse) misleading. Interrater Reliability Analysis is a significant problem that has attracted a great deal of research (Ubersax, 2007; Garson, 2007; Lombard, 2005). Choosing the correct procedure to aggregate the grader scores depends critically on the type of data with which one starts —not just what the numbers or rankings look like, but what they represent.

Table 12, below, shows simple data (grades) for one of the facts the graders were looking for in the student videos. The context of the statement “Pharaoh is shown defeating the enemies of Egypt.” tells the grader that the statement refers to the artwork on the Pylon, the front of the Temple.

**Table 12.** Sample Data for One Fact

Pharaoh is shown defeating the enemies of Egypt.				
<b>Code Name</b>	<b>Getkin</b>	<b>Vadnal</b>	<b>Bruckner</b>	
Ace	half	full	full	<p>On the left is sample video rating data for a particular fact. The students, themselves, chose their own codenames. The three columns on the right contain the scores given by each grader indicating how well that grader thought each student evidenced knowledge of that fact/idea in the student's video (section 5.1, p155)</p>
ALG	none	half	half	
Anna	none	none	none	
Bam82	full	full	full	
Batman	none	none	none	
Beaver32	none	none	none	
Bubbles	none	none	none	
Butterbean	none	none	half	
Caraboo	half	full	full	
Champ	full	full	full	
Chuckles	none	none	none	
Claire	full	full	half	
Commando	none	none	none	
Deangelo	none	none	none	
DeathBrother	half	half	half	
Dolores	full	full	full	
FibMaster	none	none	none	
Fred	none	none	none	
Grechen	full	full	full	
Gumball	none	none	none	
HarpsichordDude	none	none	none	
Icarus13	none	none	none	
Jen	full	full	half	
JSS	full	full	full	
Kimiko	full	full	full	
KimKim	full	full	full	
Lulu	none	none	half	
Magma1000	none	none	none	
MandM	none	none	none	
Mara	full	full	none	
Margarita	none	none	none	
Milky	full	full	half	
MoneyBags	none	none	none	
MrBeans	none	none	none	
Natalie	half	none	none	
Nellie	none	none	none	

Pharaoh is shown defeating the enemies of Egypt.				
<b>Code Name</b>	<b>Getkin</b>	<b>Vadnal</b>	<b>Bruckner</b>	
NicelyNicely	none	none	none	
Noah	none	none	none	
Pinky	none	none	none	
PinkySprinkles	none	none	none	
Pumpkin	none	none	none	
Renee	none	none	none	
Shadow	none	none	none	
Skizzy	half	full	half	
Snickers	none	none	none	
Sparkey	none	none	none	
Spicy44	none	none	none	
Spiderman	none	none	none	
StarFire	none	none	none	
Superman	full	full	half	
The	none	none	none	
TRCB	full	full	full	
TreeHugger	full	full	full	
Twister22	half	half	half	
Vegitomsn	full	full	full	
Vivi	none	none	none	
Whatever	none	none	none	
Xavier	none	none	none	
Zulu1138	half	half	half	

### 5.3.1 Our Data is Ordinal and Not Normally Distributed

Because the graders were evaluating simple facts and ideas already presented in *Gates of Horus*, we used three-level Likert scales (“none,” “half,” “full”), despite the fact that five-level scales are much more commonly used in social science research. Adding more levels (e.g., “none,” “some,” half, “a lot,” “full”) would have created false granularity to the results and burdened the graders unnecessarily. Five-level Likert scales are convenient, because one can often convert the ratings into numbers and analyze the results using parametric methods (Garson, 2007), which are more sensitive than non-parametric methods.

Converting Likert scale ratings to absolute numbers assumes a fixed distance between the levels of the ratings, a distance that is the same for all pairs of adjacent levels. This would not be a problem if, for example, one asked the raters to determine whether a glass of water is empty, half full, or completely full. For topics that are much more subjective or theoretical, such as the beauty of the day or the relevance of a political theory, one cannot assume a fixed distance or difference between levels. In practice, however, one can usually treat five or more levels of most judgments, as if the differences were fixed and use parametric methods in reasonable safety (Jaccard, 1996).

However, we use only three-level Likert scales, and it would make no sense to assign an absolute distance between “none” and “half” or “half” and “full” on our scale. The data is not continuous, but it does have defined ordering in the values, making it ordinal (Wikipedia, 2007a). We cannot use parametric methods on this data, because three levels is insufficient to reliably define a normal curve.

The other reason we do not want to use a parametric method is that our data is heavily weighted towards “none” grades, making the data’s distribution strongly non-normal. Because there are so many facts in the temple, the students could not be expected to remember them all and describe them in the video test. This gave our measurement depth, but it prevented our data from being normally distributed because of the high level of “none” values. Converting all the data points to Z-scores, which are normally distributed by definition, does not work either. It is very hard to impute a believable normal curve using only three data points, regardless of how those points are distributed.

### 5.3.2 Calculating Interrater Reliability

Before we chose our method for judging interrater reliability, we had to define exactly what **type** of agreement we were measuring. In our experiment, we were primarily interested in whether students in one experimental condition were more than students in a different condition. We were less interested in whether one grader was consistently more generous than another—we were more interested in whether the graders agreed on which students did relatively well and which did relatively poorly. However, using a test that is sensitive to grader bias protected us in cases where one or more graders' scores associated with a fact diverged sharply. There do not appear to have been many cases where this happened but the added protection was still an advantage. Therefore, we were primarily interested in whether the graders' scores varied in tandem (correlation), but we also have a lesser interest in measures of grader bias.

A measure of correlation would satisfy of our needs, because such measures compare variations in grading and we could use separate tests for grader bias, as needed. However, our data is non-continuous, so we could not use the typical measure of correlation (i.e. Pearson's-R). We then considered using Spearman's-R, a common non-parametric alternative test, "...which is simply Pearson's-R computed on the ranks and average ranks [of the data]" (Conover, 1999, p314-315). However, the non-normal distribution of our data made this test unworkable. Using either correlation measure would be overly conservative, reporting lower levels of agreement than were actually present (type-2 error).

We chose **Fleiss Kappa** (Fleiss, 1981; Shrout, 1979; Siegel, 1988, p284), which has been used productively for nonparametric interrater reliability analysis for a long time (Ubersax, 2007; King, 2004). It is sensitive to grader bias, but not overly so. Most importantly, it is designed to handle ratings with very few levels (i.e., True/False, high/medium/low, etc.) and to handle any number of raters. To compute Fleiss Kappa, we found it most convenient to use the code in the spreadsheet produced by King (2004).

The final result was a probability score (approximate standard error from Fleiss, 1979) for each question indicating whether the graders were substantially in agreement on the quality of all students' performance with regard to the fact being graded. If the standard approximate

error was  $P < 0.05$ , there is a 95% chance that all three graders are truly in agreement on all students' performance (taken together) with regard to that fact, despite a small amount of random fluctuation.

Students' membership in an experimental treatment group was **not** a factor. We were concerned only with whether the graders were in agreement for each student.

### 5.3.3 Grader Agreement

Overall, grades for students' explanation of 47 out of the 77 (64%) facts show acceptable levels of rater agreement ( $p < 0.5$ ). Although only 64% of the facts led to useable data, they accounted for 89.38% of all points awarded. This is because students earned very few points from the graders in most of the rejected cases. This is logical, because when the graders award very few points for students' sparse mention of a fact, small and perhaps random variations can produce what looks like a large lack of agreement.

To verify this, we wanted to create a total value for each fact showing how many points all of the graders assigned to all of the students for their performance with regard to each fact. To do this, we created an alternate version of the data where "none" was converted to 0, "half" became 0.5, and "full" was scored as 1. This allowed us to simply add all the ratings together to get the total to produce a reasonable measure of how frequently all student presented the fact and in a way the graders could understand. We are careful *not* to use the grades-as-numbers for any parametric test (section 5.3, p163).

Table 13, below, shows which sets of data (per fact) are acceptable for further analysis. We reject those where Fliess Kappa 's error value (P) is greater than 0.05. Also, the last column shows the total number of points assigned by all graders to all students for each given fact. We also reject data sets where no graders assigned any credit to any students. In these cases we have no data to use for any further analysis, and the Kappa statistic is undefined. We copied all the data with acceptable Kappa P-values into HypothesisText.xls for comparative analysis.

**Table 13.** Interrater Reliability Analysis of the Video Data

Category	Question	Kappa P-value	p < 0.05?	Point Total
PYLON FACTS	The temple is well ordered	0.7845		2
	the Pylon is a symbol of what Egypt could be	0.9753		1.5
	the Pylon is the most massive part of the temple.	<b>0.0017</b>	Yes	14.5
	the Pylon was colorful.	<b>0.0383</b>	Yes	10.5
	the colors of the Pylon had been worn away over time.	<b>0.0017</b>	Yes	13
	the Pylon represents the mountains on either side of the Nile.	<b>0.0190</b>	Yes	7
	pharaoh is shown defeating the enemies of Egypt	<b>0.0000</b>	Yes	56
	The God grants pharaoh his authority	<b>0.0013</b>	Yes	19
	a sword represents the authority that the god gives to pharaoh	<b>0.0018</b>	Yes	12
	This temple is dedicated to the god Horus	<b>0.0000</b>	Yes	35.5
	the hawk statues represent Horus	<b>0.0000</b>	Yes	62
	horus protects pharaoh	<b>0.0029</b>	Yes	45.5
	the statue of pharaoh beneath the hawk's breast shows that the god protects him.	<b>0.0000</b>	Yes	76
	Horus represents all gods	<b>0.0136</b>	Yes	9.5
	pharaoh is the link between the people and the gods	<b>0.0154</b>	Yes	9
	pharaoh and the gods are united for the good of the world	0.5680		2.5
	horus is the god of Kingship			0
	the hawk is the symbol of Horus	0.6825		12.5
	The winged disk is a symbol of unity and protection	<b>0.0001</b>	Yes	24.5
	the winged desk represents the divine life-force			0
to winged disk is a symbol of the world	0.9954		0.5	
			0	
the winged disk represents life	0.9867		1	
			0	
PYLON GOAL	The Egyptians thought that the world was orderly.	0.9546		3
	The Egyptians thought the world was centered on Egypt and it's gods.	0.6786		3
COURTYARD FACTS	The Courtyard holds several hundred.	0.7284		3

Category	Question	Kappa P-value	p < 0.05?	Point Total
	Everybody could come there from, Farmer to Pharaoh	<b>0.0000</b>	Yes	78.5
	Open and undivided.	<b>0.0039</b>	Yes	17.5
	made for large religious celebrations.	<b>0.0000</b>	Yes	75
	The celebrations were joyous.	<b>0.0602</b>		12.5
	The joy of the celebrations showed people's gratitude to the gods.	0.7449		7.5
	everyone offered their best things at the celebrations	<b>0.0011</b>	Yes	21.5
	Everyone came wearing simple garments to show their humility before the gods.	<b>0.0000</b>	Yes	39.5
	The open sky indicates the connection between heaven and earth.	<b>0.0000</b>	Yes	68.5
	The sun represents the creator god, Amon.	0.2179		4.5
	All Egypt was (supposed to be) united under the sun.	0.9867		1
	The offering scene mural shows pharaoh giving "every good thing" to the god	<b>0.0000</b>	Yes	65.5
	The offering scene mural Shows the god blessing the King and Egypt with life and prosperity.	<b>0.0003</b>	Yes	29.5
	On the pillar, the Pharaoh and Horus embrace.	<b>0.0379</b>	Yes	9.5
	On the pillar, Horus represents the gods and the natural world			0
	On the pillar, Horus and Pharaoh embracing represents the gods and humanity coming together	0.1554		8
COURTYARD GOAL	The people gave thanks to the gods as a community.	0.4531		45.5
HYPOSTYLE HALL FACTS	the hall is a quiet and private place	<b>0.0503</b>		12.5
	the hall is built on a grand scale to let you know it is sacred	0.9954		0.5
	only the literate class could come here	<b>0.0001</b>	Yes	37
	they honored their ancestors here	<b>0.0000</b>	Yes	85.5
	by honoring their ancestors they connected with heaven	<b>0.0023</b>	Yes	15.5
	They made offerings to their ancestors	<b>0.0014</b>	Yes	34.5
	the offerings were placed before statues of their ancestors	0.3523		14
	anyone could have an ancestor statue at work or at home	<b>0.0007</b>	Yes	16



Category	Question	Kappa P-value	p < 0.05?	Point Total
	if you made a big donation to the temple you could have an ancestor statue tonight the hall.	<b>0.0000</b>	Yes	64
	the columns represent the primeval marsh.	<b>0.0000</b>	Yes	22
	the marsh surrounded the first mound of land	0.9954		0.5
	the first land rose from the waters at the beginning of time	0.8543		4
	The hawks on the ceiling are spirit guides	0.0842		13
	the hawks guide you deeper into the temple	<b>0.0000</b>	Yes	31
	the hawks show the connection between heaven and earth	<b>0.0002</b>	Yes	26.5
HYPOSTYLE HALL GOAL	The Hypostyle Hall is an intimate space.	0.5772		12
	The Hypostyle Hall provides the worshiper a private connection to the divine.	0.3627		26.5
SANCTUARY FACTS	the Sanctuary is the most important part of the temple	<b>0.0000</b>	Yes	41.5
	the Sanctuary has the best decorations	<b>0.0011</b>	Yes	18
	everything there is made of the best materials	0.4796		2
	the most important ceremonies happened there	0.1693		15
	the ground under the Sanctuary was the very first part of the world.	<b>0.0000</b>	Yes	68.5
	Time began here.	<b>0.0129</b>	Yes	39.5
	Every Egyptian town from the world again under their particular temple.	<b>0.0000</b>	Yes	25.5
	The divine image of Horus stands in the shrine.	<b>0.0000</b>	Yes	84.5
	Horus represents all gods.	<b>0.0000</b>	Yes	26.5
	At times, the spirit of the God inhabits the divine image.	<b>0.0000</b>	Yes	26
	If the god was pleased, he would make good things happen for the community, such as a good harvest.	<b>0.0001</b>	Yes	32
	The shrine was the gateway to heaven.	<b>0.0005</b>	Yes	21.5
	The blessings of heaven flow from the shrine, Through the temple, and on to Egypt.	<b>0.0053</b>	Yes	24
	Pharaoh makes the blessings of heaven flow, by conducting the proper ceremonies correctly.	<b>0.0000</b>	Yes	45
	The high priest could act in pharaoh's place.	<b>0.0000</b>	Yes	43
SANCTUARY GOAL	pharaoh communicates with the gods	<b>0.0142</b>	Yes	42.5
SANCTUARY GOAL	here, pharaoh brings down the blessings of heaven by honoring the gods	<b>0.0048</b>	Yes	39

## 5.4 RESULTS, FACTUAL KNOWLEDGE

Data from the video tests is suitable for evaluating Hypothesis 2 (H2, section 3.2, p96) by comparing grades of the Theater Group to (1) grades of the Desktop Group and (2) grades of the Desktop and Control Groups, taken together. While the second comparison conveys the statistical advantage of comparing larger groups, it gives the aggregate non-Theater Group an unfair advantage. Students in the Control Group had more exposure to the material because they took the Post Test before playing the *Game of Horus*. To find a significant difference, the positive effects of using the theater would have to be strong enough to overcome this slight advantage.

We made these comparisons on each set of rater-produced data associated with each fact. However, we had to first find a way to aggregate the data from all three raters, so that there was a single rating for each fact for each student. Therefore, we converted all the data into numbers where, “none” = 0, “half”=0.5 and “full”= 1, as shown with the sample data in Table 14, below.

**Table 14.** Sample Data Converted To Numbers

<b>Pharaoh is shown defeating the enemies of Egypt.</b>				
<b>Code Name</b>	<b>Getkin</b>	<b>Vadnal</b>	<b>Bruckner</b>	<b>AVERAGE</b>
Ace	0.5	1	1	0.8333
ALG	0	0.5	0.5	0.3333
Anna	0	0	0	0
...	...	...	...	...
Xavier	0	0	0	0
Zulu1138	0.5	0.5	0.5	0.5

Had the data for this fact *not* passed our interrater reliability analysis (section 5.3, p163), simply averaging the student-by-fact grades would have been inappropriate. For example, two graders might disagree strongly and give opposite results when deciding what grades should be awarded for student performance around some fact. An average or a total of their scores could cancel the effect of two widely divergent scores, leaving the third rater with disproportionate

influence. In cases where the data had passed our interrater reliability analysis, all three raters were in substantial agreement, so the average is a valid measure to use for analysis. Therefore, we were able to produce a single spreadsheet based on these average values. Table 15, below, shows part of it.

**Table 15.** Sample Portion of Hypothesis Test Tables

Area ->			COURT YARD						ALL
Fact ->		...	Everybody could come there from, Farmer to Pharaoh	...	everyone offered their best things at the celebrations	...	Courtyard Average	...	Grand Average
Fact (short name) ->		...	ceverybody	...	cbest	...	caverage	...	GrandAve
Student Name									
Anna	C	...	0	...	0	...	0.2963	...	<b>0.2741</b>
Bam82	C	...	1	...	0	...	0.1852	...	<b>0.0593</b>
Batman	C	...	0	...	0	...	0.0185	...	<b>0.1185</b>
...	...	...	...	...	...	...	...	...	...
MoneyBags	D	...	0	...	0	...	0.0000	...	<b>0.0148</b>
Noah	D	...	0.5	...	0.3333	...	0.1481	...	<b>0.1370</b>
Spiderman	D	...	0	...	0	...	0.0185	...	<b>0.1370</b>
...	...	...	...	...	...	...	...	...	...
TreeHugger	T	...	1	...	0.3333	...	0.5556	...	<b>0.4630</b>
Vegitomsn	T	...	1	...	0	...	0.6111	...	<b>0.3630</b>
Zulu1138	T	...	0	...	0	...	0.3333	...	<b>0.2556</b>
<b>Mann-Witney,</b>			<b>0.6327</b>		<b>0.0303</b>		<b>0.0649</b>		<b>0.0330</b>
Polarity (aveT - aveCD)					+		+		+
Total Points			26.17		7.17		15		12.0481

In Table 15, above, the left column shows students’ short names, and all data in each row belongs to the student named. Similarly, each column represents all of the data associated with a fact stated in the column heading. Students’ data are sorted into three groups as indicated by the second column, Control (C), Desktop (D), and Theater (T). Data for facts are grouped by major area of the Temple (e.g., “Courtyard”). The columns, “ceverybody” and “cbest” contain examples of data associated with basic facts. Remember that these numbers are the average scores given by all three raters when they were asked to look for evidence of the fact named at the top of the column in each student’s video.

The data in each cell of column “Courtyard Average” is a simple arithmetic average of all the (average) scores for a particular student for facts regarding the Courtyard of the Temple.

Similarly, the Grand Average is the arithmetic average of all facts in all areas – it is *not* an average of the averages. This means that some areas will contribute more weight to the final result than others, either because more of the area’s component grades survived interrater reliability analysis, or because the point totals were higher for student performance for the area’s facts.

In the Grand Average and in the Sanctuary Average we excluded data for the two “Goal Questions” associated with the Sanctuary. These Two Goal Questions were intended to be a different measure from simple factual questions, measuring a deeper level of learning. To answer the goal questions, the students (we believe) had to infer facts from the information all of the other “Clues” and questions provided for that area of the temple. However, for the Sanctuary area, only the Goal Questions survived Interrater Reliability Analysis (section 5.3, p163). Combining those scores with the Sanctuary average would make it incomparable to averages in the other areas. Given how unstable IRR analysis showed the Goal Questions measure was, we do not wish to combine the Sanctuary goal data with the grand average. It is better that the grand average remain a purer measure of low-level factual learning than a suspect measure of broader learning.

Next, we chose a measure to compare data among the different treatment groups. In this, we encountered similar issues we confronted when choosing a measure for interrater reliability. Because our original data is fundamentally ordinal, we could not safely use a parametric test, even on these averages, which appear to have a reasonable number of levels. The averages are expressed as numbers which are continuous, but the underlying data is not continuous. Also, the data is not distributed normally, which further disqualified parametric tests.

Therefore, we used the Mann-Whitney test, a nonparametric alternative to the T-Test that works with ranks of the data values rather than the data values themselves. To compare data among three groups, we used the Kruskal-Wallis test, a nonparametric replacement for the ANOVA test. The Kruskal-Wallis test is identical to the Mann-Whitney test when applied to data from only two groups, just as a two-group comparison with ANOVA is equivalent to the T-Test. In practice we find both ANOVA and Kruskal-Wallis to be of limited use. All they could tell us is that among three or more groups there is some sort of difference, not where the difference actually lies.

**Table 16.** Factual Recall, Theater Group versus All Others

<b>Fact</b>	<b>Short Name</b>	<b>Point Totals</b>	<b>P-value</b>
<b>PYLON</b>	<b>paverage</b>	<b>28.14</b>	<b>0.0962</b>
a sword represents the authority that the god gives to pharaoh	psword	12	<b>0.0172</b>
pharaoh is the link between the people and the gods	plink	9	<b>0.0499</b>
Horus represents all gods	prepresents	9.5	0.1887
the hawks statues represent Horus	phawks	62	0.1891
This temple is dedicated to the god Horus	pdedicated	35.5	0.2063
The winged disk is a symbol of unity and protection	psymbol	24.5	0.2224
the Pylon represents the mountains on either side of the Nile.	pmountain	7	0.2813
The god grants pharaoh his authority	pgrants	19	0.3128
pharaoh is shown defeating the enemies of Egypt	pdefeating	56	0.3315
the Pylon is the most massive part of the temple.	pmassive	14.5	0.3400
the Pylon was colorful.	pcolorful	10.5	0.3580
horus protects pharaoh	pprotects	45.5	0.8838
the statue of pharaoh beneath the hawk's breast shows that the god protects him.	pstatue	76	0.9553
the colors of the Pylon had been worn away over time.	pcolorworn	13	0.9640
<b>COURTYARD</b>	<b>caverage</b>	<b>45.00</b>	<b>0.0649</b>
Everyone came wearing simple garments to show their humility before the gods.	csimple	39.5	<b>0.0017</b>
everyone offered their best things at the celebrations	cbest	21.5	<b>0.0303</b>
On the pillar, the Pharaoh and Horus embrace.	cembrace	9.5	<b>0.0962</b>
The offering scene mural Shows the god blessing the King and Egypt with life and prosperity.	cblessing	29.5	0.2042
made for large religious celebrations.	ccelebrate	75	0.3209
The offering scene mural shows pharaoh giving "every good thing" to the god	cgiving	65.5	0.3348
Open and undivided.	copen	17.5	0.6103
Everybody could come there from, Farmer to Pharaoh	ceverybody	78.5	0.6327
The open sky indicates the connection between heaven and earth.	cconnect	68.5	0.9858
<b>HYPOSTYLE HALL</b>	<b>haverage</b>	<b>36.89</b>	<b>0.0865</b>
if you made a big donation to the temple you could have an ancestor statue tonight the hall.	hdonation	64	<b>0.0035</b>
They made offerings to their ancestors	hancestors	34.5	<b>0.0995</b>
only the literate class could come here	hliterate	37	0.1986

they honored their ancestors here	hhonored	85.5	0.2969
the columns represent the primeval marsh.	hmarsh	22	0.3062
anyone could have an ancestor statue at work or at home	cworkhome	16	0.4037
by honoring their ancestors they connected with heaven	hheaven	15.5	0.5328
the hawks guide you deeper into the temple	chawks	31	0.5959
the hawks show the connection between heaven and earth	cshow	26.5	0.6407
<b>SANCTUARY</b>	<b>saverage</b>	<b>38.13</b>	<b>0.0359</b>
At times, the spirit of the God inhabits the divine image.	sinhabit	26	<b>0.0001</b>
The divine image of Horus stands in the shrine.	sdivine	84.5	<b>0.0300</b>
If the god was pleased, he would make good things. happen for the community, such as a good harvest.	sgood	32	<b>0.0512</b>
the Sanctuary has the best decorations	sdeocor	18	<b>0.0541</b>
Every Egyptian town from the world again under their particular temple.	sbegan	25.5	<b>0.0594</b>
Time began here.	stime	39.5	<b>0.0785</b>
Horus represents all gods.	sallgods	26.5	<b>0.0922</b>
the ground under the Sanctuary was the very first part of the world.	sfirst	68.5	0.2052
The shrine was the gateway to heaven.	sgateway	21.5	0.3244
the Sanctuary is the most important part of the temple	simportant	41.5	0.5130
Pharaoh makes the blessings of heaven flow, by conducting the proper ceremonies correctly.	sproper	45	0.7169
The high priest could act in pharaoh's place.	spriest	43	0.8173
The blessings of heaven flow from the shrine, Through the temple, and on to Egypt.	sflow	13 24	1.0000
<b>GRAND TOTAL</b>	<b>grandtotal</b>	<b>36.15</b>	<b>0.0458</b>
<b>SANCTUARY GOAL QUESTIONS</b>			
pharaoh communicates with the gods	sgconverse	42.5	0.3986
here, pharaoh brings down the blessings of heaven by honoring the gods	sgbring	39	0.1266

Table 16, above, summarizes the results from our evaluation of the video test data produced by Bruckner, Getkin and Vadnal grading the student videos for the presence of certain facts. In the table, each fact has a row of data under the area of the temple to which it applies. The first column shows the full text describing the fact. The second column carries the fact's short name.

The third column, "Point Totals," represents the sum of all points awarded by all graders for the fact in the first column for that row. It shows the main effect across all groups for learning that fact, which is instructive in understanding the learning game the *Gates of Horus* (add link). Also, it shows the reader how much each fact contributed to the area average. For example, fact "psword" received 12 total points, which is less than half the average points received for facts in the Pylon area, which is 28.14 points. The grand average is shown above lines referring to *Goal Questions*, because those questions are not included in the grand average.

The fourth column is the most important. It shows P-values produced by the Mann-Whitney test comparing the grades awarded to the Theater Group and those awarded to students in the other two groups. For example, if  $P = 0.05$ , it means that there is only a 5% chance that the observed difference is a random event, and therefore it is probably real. For each fact where the difference is  $P < 0.10$ , the polarity of that difference is always in favor of the Theater Group, so we do not report any of the comparison polarities here. P-values less than 0.1 are shown in boldface type. For each area, all facts are sorted according to the P-value produced by the Mann-Whitney test, in the last column.

It is important to understand that the P-value for each major area (e.g.,  $P = 0.0649$  for the Courtyard) is NOT a simple average of the P-values for the facts in that area. For each student, we computed the average number of points s/he received for all facts in each major area. The P-value for an area is computed by comparing the group averages for points for all facts in that area. That is why the P-value for a major area can be lower than most of the P-values for the facts in it. However, we cannot simply look at the area averages, because there are ways for any average to look valid while its component data is contradictory.

The P-values for the overall Grand Totals is an excellent  $P = 0.0458$ , showing that there is a very likely real difference in results between the Theater Group and the other students. Furthermore, the overall P-value for the Sanctuary ( $P = 0.0359$ ) is even better—not just because it is the lowest for the four areas, but also because the P-values for seven of its 13 facts



individually are favorable P-values, less than 0.01. The Sanctuary is the most important area in the temple, where all of the themes in the temple come together. The overall results for the sanctuary can reasonably be used as the primary result of this test.

We also did a separate comparison between the Theater Group and the Desktop Group. None of the P-values were below 0.1. Had results from the two comparisons pointed in different directions, the premise of aggregating the Control Group and Desktop Group scores (H2, section 3.4 above) might have been in doubt. As it stands, the failure of the Desktop versus Theater Group comparison was probably did not involve enough students. (N was too small.) Given the rationale for H2, we saw no reason to look more closely at this.

Nevertheless, these results are very encouraging. They show that students using the immersive display appeared to learn more than those using only a desktop monitor

## **5.5 RESULTS, CONCEPTUAL KNOWLEDGE**

We desired a deeper measure of learning, so we constructed a grading questionnaire intended for an expert on Egypt, generally, and in our Virtual Temple, specifically. At the time, the only expert available was Dr. Lynn Holden, our content expert. While he was fully aware of the study goals and structure, he did not know any student's test group membership when he was grading their videos. At the time, he lived in a different city and was not involved in any of the day-to-day operations of the experiment. We constructed a questionnaire focusing on whether the student in a video seemed to have a grasp of certain concepts. Dr. Holden watched each video and circled the appropriate answers for each question. We later transcribed his answers into a spreadsheet via a form in Survey Monkey. We have reproduced the questionnaire in Figure 39, below.

<i>Student</i>	<i>Grader</i>	<i>Date</i>
<b>Did the student say anything?</b>	<b>Does the student appear to be integrating knowledge, ideas, etc. from other sources, besides the game (other books, museum, online resources, etc.)</b>	<b>Does the student make a sensible final statement about the temple which integrates everything.</b>
Yes      No		
<b>Does the student seem to know the facts the s/he is talking about.</b>		Excellent
	Excellent	Good
	Good	Fair
Excellent	Fair	Poor
Good	Poor	Not at all
Fair	Not at all	
Poor		<b>Is the student connecting the facts with the visuals?</b>
Not at all	<b>How many wrong facts did the student voice?</b>	Excellent
	One	Good
<b>Is the student inventing facts?</b>	Two	Fair
A lot	Three	Poor
Some	Many	Not at all
None		
<b>Does the student discuss the most important concepts about the temple learned from the game?</b>	<b>When in one space, does the student refer to objects in the other spaces?</b>	<b>Is the student making connections between the different elements of the temple.</b>
	Excellent	Excellent
	Good	Good
<b>Pylon:</b>	Fair	Fair
Form,	Poor	Poor
Balance	Not at all	Not at all
Royal Power		
<b>Courtyard:</b>	<b>Is the student doing a good job integrating the visual and verbal knowledge they got from the game.</b>	<b>Did the student demonstrate understanding of concepts other than the five.</b>
Public	Excellent	Excellent
Festival	Good	Good
Equality	Fair	Fair
	Poor	Poor
<b>Hypostyle Hall:</b>	Not at all	Not at all
Privacy		
Ancestors	<b>Is the student drawing connections between the different spaces.</b>	<b>What is your overall impression of the student's performance.</b>
Offerings/ Sacrifice	Excellent	Excellent
	Good	Good
<b>Sanctuary:</b>	Fair	Fair
Secret	Poor	Poor
Divine Presence	Not at all	Not at all
Original Place		

**Figure 39.** Conceptual Grading Form.

The results showed a strong difference between ratings Dr. Holden gave to students in the Theater Group and the ratings he gave to all other students. Importantly, Dr. Holden's conceptual-level grades parallel grades given by the other three evaluators for more factual questions. The narrower comparison of results from the Theater Group and from the Desktop Group showed a very similar pattern, and many of the results were significant and paralleled the Theater-verses-all-others comparison. We will report the details of the latter comparison.

We computed these results in exactly the same way as we did for the factual data, except that there was no need for interrater reliability analysis. Table 17 reports the key values computed from the Mann-Whitney test for each concept, and the point totals. P-values less than 0.1 are shown in boldface type. All of the averages (except "cave") show P-values less than 0.1, and each one has his significant percentage of its component concepts also have low P-values.

**Table 17.** Conceptual Understanding, Theater Group versus All Others

Theme	Short Name	P-value	Total Points
Does the student seem to know the facts that s/he is talking about?	overall1	<b>0.0001</b>	30.5
Does the student discuss the most important concepts about the temple learned from the game? Pylon	Form	0.7246	9
	Balance	1.0000	2
	Royal Power	<b>0.0634</b>	26
Pylon Average	pave	<b>0.0602</b>	12.33
Does the student discuss the most important concepts about the temple learned from the game? Courtyard	Public	0.7812	19
	Festival	0.7812	19
	Equality	<b>0.0703</b>	15
Courtyard Average	cave	0.2123	17.67
Does the student discuss the most important concepts about the temple learned from the game? Hypostyle Hall	Privacy	0.3626	14
	Ancestors	<b>0.0362</b>	30
	Offerings/Sacrifice	1.0000	24
Hypostyle Hall Average	have	<b>0.0637</b>	22.67
Does the student discuss the most important concepts about the temple learned from the game? Sanctuary	Secret	1.0000	11
	Divine Presence	<b>0.0179</b>	34
	Original Place	0.1684	21
Sanctuary Average	save	<b>0.0184</b>	22
Does the student appear to be integrating knowledge, ideas, etc. from other sources, besides the game (other books, museum, online resources, etc.)	outside	0.8438	3.75
When in one space, does the student refer to objects in the other spaces?	spaceobj	1.0000	2.75
Is the student doing a good job integrating the visual and verbal knowledge they got from the game.	visverb	<b>0.0001</b>	29.75
Is the student drawing connections between the different spaces.	space to space	0.1053	5
Is the student connecting the facts with the visuals?	factviz	<b>0.0002</b>	30
Is the student making connections between the different elements of the temple.	elements	0.3460	6

Theme	Short Name	P-value	Total Points
Did the student demonstrate understanding of concepts other than the five.	concepts	0.7589	0.75
Components Average Includes the area averages (e.g. Courtyard Average) and all the Likert question values.	compave	<b>0.0040</b>	11.14
What is your overall impression of the student's performance.	Overall2	<b>0.0004</b>	31.75

The first question, “overall1,” asks the rater to give a general impression of how competent the student appears to be at the beginning of the video. The last question, “overall2” asks for the rate, *after* he has seen the entire video. The Mann-Whitney comparison shows a clear advantage for the Theater Group in both questions, with  $P(\text{overall1}) = 0.0001$  and  $P(\text{overall2}) = 0.0004$ , which are nearly equal. The data for both of those questions are also very strongly correlated, with Pearson's  $R=0.9305$ , indicating that they vary in tandem.

Furthermore, “compave” shows the result of a Mann-Whitney comparison on all the other data, averaged into a single column. The result is also very strong,  $P = 0.004$ , in favor of the Theater Group having genuinely learned more than the others. There is some correlation between the “compave” data and the data for “overall1,”  $R = 0.7616$ , and “overall2,”  $R = 0.7796$ . Essentially, we asked for a general assessment of each student's performance in three different ways, and all three answers correlate, which speaks well for the stability of the results.

Results from the other requested judgments, below the Sanctuary Average, are also interesting. The Theater Group students received higher marks for integrating visual and verbal information (“factviz,” “visverb” and “space to space”), which we would expect (see section 3.2, p96). We believe that our visually immersive display was a much better vehicle for communicating the way the Egyptians expressed information in their religious architecture. We remind the reader that the Egyptians were very skilled at visual communication, which is why we chose this subject matter. Results of the other general questions, “concepts,” “elements,” “spaceobj” and “outside,” showed little or no difference between the groups. This is almost certainly because they had very low point totals, which generally causes Mann-Whitney test to produce a higher P-value to reflect the uncertainty of making conclusions based on a small number of data points.

**Table 18.** Connections Between Factual Recall and Conceptual Understanding

P-value	Themes	Connection	Concepts	P-value
			pmassive	0.3400
			pcolorful	0.3580
			pcolorworn	0.9640
			pmountain	0.2813
0.7246	Form		pdefeating	0.3315
			pgrants	0.3128
1.0000	Balance		<b>psword</b>	<b>0.0172</b>
			pdedicated	0.2063
<b>0.0634</b>	<b>Royal Power</b>		phawks	0.1891
			pprotects	0.8838
<b>0.0601927</b>	<b>pave</b>		pstatue	0.9553
			prepresents	0.1887
			<b>plink</b>	<b>0.0499</b>
			psymbol	0.2224
			<b>paverage</b>	<b>0.0962</b>
0.7812	Public		ceverybody	0.6327
			copen	0.6103
0.7812	Festival		ccelebrate	0.3209
			<b>cbest</b>	<b>0.0303</b>
<b>0.0703</b>	<b>Equality</b>		<b>csimple</b>	<b>0.0017</b>
			cconnect	0.9858
0.2123	cave		cgiving	0.3348
			cblessing	0.2042
			<b>cembrace</b>	<b>0.0962</b>
			<b>caverage</b>	<b>0.0649</b>
			hliterate	0.1986
			hhonored	0.2969
			hheaven	0.5328
0.3626	Privacy		<b>hancestors</b>	<b>0.0995</b>
			cworkhome	0.4037
<b>0.0362</b>	<b>Ancestors</b>		<b>hdonation</b>	<b>0.0035</b>
			hmarsh	0.3062

P-value	Themes	Connection	Concepts	P-value
1.0000	Offerings/ Sacrifice		chawks	0.5959
			cshow	0.6407
<b>0.0637</b>	<b>have</b>		<b>haverage</b>	<b>0.0865</b>
			simportant	0.5130
			<b>sdeocor</b>	<b>0.0541</b>
			sfirst	0.2052
			<b>stime</b>	<b>0.0785</b>
1.0000	Secret		<b>sbegan</b>	<b>0.0594</b>
			<b>sdivine</b>	<b>0.0300</b>
0.1684	Original Place		<b>sallgods</b>	<b>0.0922</b>
			<b>sinhabit</b>	<b>0.0001</b>
<b>0.0179</b>	<b>Divine Presence</b>		<b>sgood</b>	<b>0.0512</b>
			sgateway	0.3244
<b>0.0184</b>	<b>save</b>		sflow	1.0000
			sproper	0.7169
			spriest	0.8173
			<b>saverage</b>	<b>0.0359</b>
<b>0.0001</b>	<b>overall1</b>		<b>GrandAve</b>	<b>0.0330</b>

Table 18, above, shows several important connections between the high-level learning reported by Dr. Holden and the factual grading by the other raters. The results show a strong difference between ratings given to students in the Theater Group and ratings given to all other students. Most importantly, Dr. Holden's conceptual-level grades parallel grades given by the other three evaluators for more factual questions. The narrower comparison of results for the Theater Group and those for the Desktop Group showed a very similar pattern, and many of the results were significant and paralleled the Theater-verses-all-others comparison. We will report the details of the latter comparison.

We computed these results in exactly the same way as we did for the factual data, except that there was no need for interrater reliability analysis. Table 18 reports the key values computed from the Mann-Whitney test for each concept, and the point totals. P-values less than 0.1 are shown in boldface type. All of the averages (except "cave") show P-values less than 0.1, and each average also has significant percentage of its component concepts with low P-values. The arrows connect concepts with related facts. Notice how every concept where the Theater Group did significantly better is connected to at least one related fact where the Theater Group also did better. This is why we say that the conceptual learning results parallel the factual learning results.

In the area of Pylon facts, Theater Group students were significantly better at remembering that Pharaoh's sword represents his authority (psword) and that he is the link between the people and the gods (plink). The Theater students *also* scored significantly higher in understanding the *theme* of royal power (rpower), which is strongly connected to the two facts.

Comparisons for the fact, "Pharaoh defeats the enemies of Egypt," do *not* show a significant difference between test groups; this is probably due to a "ceiling effect." Total points awarded for all students on this fact by all three graders equal 56 points which is very high. It is most likely that this fact is so obvious that all students did well with it regardless of interface.

Similarly, students in the Theater Group did better with the concept "Group," and they also had superior recall for the fact that everyone wore the same simple garments when they gathered in the Courtyard for festivals (csimple).

Students in the Theater Group were better at remembering that the Egyptians honored their ancestors in the Hypostyle Hall (hancestors), and they also showed better understanding of the larger concepts around ancestor worship in the Hypostyle Hall (ancestors).



Students in the Theater condition showed a better understanding of the theme regarding the divine presence in the Sanctuary and how it works (divine presence). This is strongly connected to the fact/idea that the divine image of Horus stands within the shrine (sdivine) and that the spirit of the god inhabits the divine image (sinhabit).

Finally, another positive result is less important, but quite interesting. Students in the immersive condition showed a significantly positive learning result for a particular theme, the idea of the divine presence of the god (Horus) in the temple Sanctuary. This appears in two factual questions in the Post Test, as well as one fact and one concept in the Video Test. We speculate that immersion creates a much more dramatic sense of presence for the student with regard to the human-sized figure of Horus stepping out from the Shrine, a sense of visual drama Egyptian temple-builders took great care to create. By feeling embodied, the student is able to experience some fraction of what a real Egyptian of that period would have, causing better recall for the most closely related ideas. Also, there is a particular question in the Post Test (about parties in the Courtyard) where the immersive condition produced a stronger than for other questions, again, most likely because make the situation feel more real, and therefore more memorable.

## 5.6 RPM INTERACTS WITH IMMERSION

All students completed the standard version of Raven's Progressive Matrices Test (Raven, 1957), which measures abstract reasoning ability through a series of non-verbal puzzles. Each puzzle is presented as a 3 x 3 grid of geometric shapes with the last one (lower right) missing. The subject must complete the grid using one of eight alternative figures, only one of which is correct.

Determining which alternative answer is correct requires the test taker to infer the logical progressions from the existing members of the grid. We used a variation of the test that takes most normal adults approximately twenty minutes to complete, and we imposed a forty-minute time limit. In effect, the test was not timed, making it more of a measure of mental *capacity* rather than mental *efficiency* (Westby, 1953).

RPM has a long history (Shiply, 1949), is very stable (Gregory, 1999) and is easy to administer. However, we must carefully define what it measures in the context of this experiment. Researchers often use Raven's Progressive Matrices (RPM) as a test for native intelligence, rather than for the effective intelligence one develops through knowledge and training. RPM is valued because most other types of intelligence test are sensitive, at least to some degree, to effective intelligence as well as to native intelligence (Gregory, 1999). But RPM is also important for another reason: it requires visual skills such as the ability to estimate relative size and shape, which may not be directly related to verbal ability. Bortner (1965) contends that the visual reasoning measured by RPM is not the same thing as general intelligence.

**Table 19.** Results from RPM Test, Question sets C & D.

9													
12													
13													
14	14	14											
15	15												
16													
17	17	17	17	17	17								
18	18	18	18	18	18	18	18	18	18	18	18	18	18
19	19	19	19	19	19	19	19	19					
20	20	20	20	20	20	20	20	20	20	20	20		
21	21	21	21	21	21								
22	22	22	22	22	23								
23	23												
24													

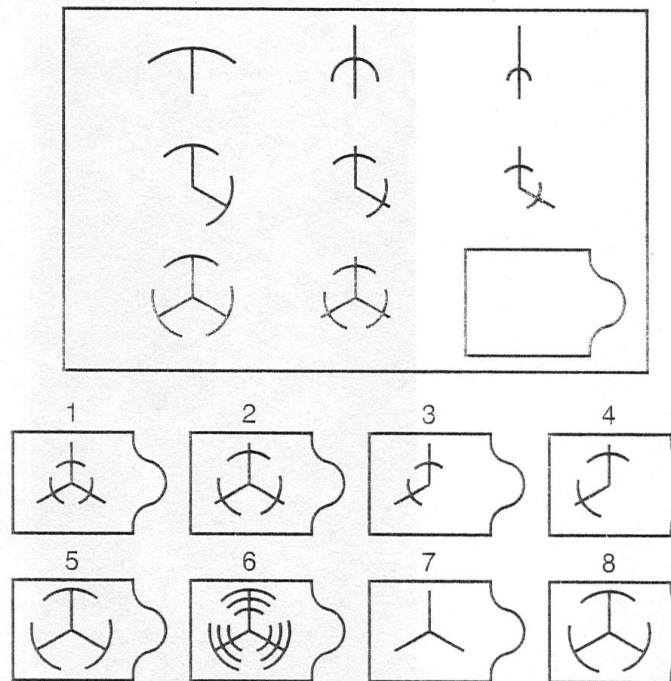

**Figure 40.** Sample Question from the RPM Test

We used RPM to measure students' reasoning ability in a way that is not affected either by verbal ability or by the student's history in the education system. This allowed us to make some interesting comparisons, because *Gates of Horus* (section 3.3, p98) is an entirely visual and auditory experience. As we describe in Hypothesis Six (**H6**, section 3.4, p119) we could see whether the students with lower ability could handle visually-mediated information benefit more from visual immersion, as Winn (1999) found. This is particularly important because it is possible that modern students' exposure to complex visual stimuli elsewhere could influence their performance (Westby, 1953). Verbal ability rather than written literacy is needed to comprehend and integrate the clues in the audio clips contained in *Gates of Horus*.

Figure 40, above, shows a sample question from the RPM test, and Table 19, above, summarizes the results. We combined the RPM scores from the Raven's progressive matrices test with other results to see if low ability students had more to gain from the immersive condition (Winn 1997). Perhaps the advantage would go to the high-scorers, or neither. Table 20, below, shows results from comparing student grades by RPM score, and by RPM score crossed with group membership, for the factual data. The results appear to show interesting trends, but nothing conclusive

**Table 20.** RPM Scores Crossed With Factual Learning Differences

	LowRPM T vs. C&D		HighRPM T vs. C&D		LowRPM vs. HighRPM	
pmassive	0.3478	+	0.7350	+	<b>0.0766</b>	+
pcolorful	0.5257	-	0.8972	-	0.3463	+
pcolorworn	1.0000	+	1.0000	+	0.8039	+
pmountain	1.0000	-	0.5257	-	0.4889	+
pdefeating	0.6524	+	0.9449	-	0.8728	-
pgrants	0.5257	+	0.7945	-	0.7489	+
psword	0.1107	+	1.0000	-	0.4889	-
pdedicated	0.3123	+	0.2418	+	<b>0.0174</b>	+
phawks	0.7912	-	0.2305	+	<b>0.0457</b>	+
pprotects	0.4178	-	0.6701	+	0.8391	+
pstatue	0.7806	-	0.7697	+	0.3597	-
prepresents	1.0000	-	0.5257	-	1.0000	+
plink	0.7628	+	1.0000	-	1.0000	-
psymbol	1.0000	-	0.0329	+	0.3488	+
<i>paverage</i>	<i>0.2708</i>	<i>+</i>	<i>0.5355</i>	<i>+</i>	<i>0.3912</i>	<i>+</i>
ceverybody	0.4651	+	0.8588	+	0.2687	+
copen	0.1107	+	0.5657	-	<b>0.0625</b>	+
ccelebrate	0.3818	+	0.4708	+	0.2269	+
cbest	0.0017	+	0.8500	-	1.0000	-
csimple	0.1028	+	<b>0.0017</b>	+	0.4217	+
cconnect	0.3366	-	0.5150	-	0.9819	-
cgiving	0.3692	+	0.6401	+	0.9300	-
cblessing	0.1114	+	0.5278	+	0.9051	+
cembrace	0.3478	+	0.3123	+	0.1680	+
<i>coverage</i>	<i>0.1032</i>	<i>+</i>	<i>0.1631</i>	<i>+</i>	<i>0.3557</i>	<i>+</i>
hliterate	0.5707	+	0.9362	+	0.1458	+
hhonored	0.4299	+	0.6853	+	<b>0.0752</b>	+
hheaven	1.0000	-	1.0000	-	0.2274	+
hancestors	<b>0.0120</b>	+	0.6509	+	0.3718	+
cworkhome	0.6917	+	0.5257	-	0.2825	-
hdonation	0.0593	+	0.2802	+	0.6259	+

	LowRPM T vs. C&D		HighRPM T vs. C&D		LowRPM vs. HighRPM	
hmarsh	0.5257	+	0.4466	+	1.0000	-
chawks	0.4916	-	0.9510	+	0.3370	+
cshow	0.0727	-	0.2969	+	0.9129	+
<i>haverage</i>	<i>0.2668</i>	<i>+</i>	<i>0.3325</i>	<i>+</i>	<i>0.1148</i>	<i>+</i>
simportant	0.2846	+	0.7149	+	0.5058	-
sdeocor	0.1436	+	0.2969	+	0.6032	-
sfirst	0.8081	+	1.0000	-	<b>0.0786</b>	+
stime	0.3987	+	0.6459	+	0.3199	+
sbegan	<b>0.0316</b>	+	1.0000	+	0.2659	+
sdivine	0.5046	+	0.1263	+	<b>0.0554</b>	+
sallgods	0.4555	+	0.1028	+	0.7222	-
sinhabit	<b>0.0017</b>	+	0.7350	+	1.0000	-
sgood	<b>0.0097</b>	+	0.4952	+	0.5666	-
sgateway	0.8738	-	0.2569	-	0.2472	-
sflow	0.1164	+	0.1221	-	0.7112	-
sproper	0.1471	+	0.3513	-	0.5266	-
spriest	<b>0.0724</b>	+	0.4324	-	0.3317	+
<i>saverage</i>	<i>0.3999</i>	<i>+</i>	<i>0.6464</i>	<i>+</i>	<i>0.2915</i>	<i>+</i>
sgconverse	0.1952	+	1.0000	+	0.2994	+
sgbring	<b>0.0110</b>	+	0.3522	-	0.9500	-
<i>GrandAve</i>	<i>0.2076</i>	<i>+</i>	<i>0.4186</i>	<i>+</i>	<i>0.2401</i>	<i>+</i>

In Table 20, above, the first column identifies temple facts by their short names (from Table 16, p176). The second column, “LowRPM T vs. C&D” shows the learning differences between low-RPM-scoring students in the Theater Group versus the low-RPM-score students in the other two groups. The numbers in that column are P-Scores produced by the Mann-Whitney test. P-Scores less than 0.1 are shown in boldface type. Although none of the area averages have a significant P-Score, there is a total of seven individual facts with P-Scores less than 0.1. One of them, “cshow” has a negative polarity, meaning that students in the Theater Group actually scored lower than students in the other groups. However, at  $P=0.0727$ , the result is weak.

It is especially interesting that the same comparison for High-RPM-scoring students (column 4) showed significant differences for only two facts. These differences are most likely random events, because they are so few. We can look at this as anecdotal evidence, a hint, that low RPM scoring students have more to gain from using the immersive interface than the high-scorers.

In Table 21, below, column labeled “LowRPM vs HighRPM” shows the main effect of Raven’s Progressive Matrices scores on students’ final scores. The premise of the comparison is that students with **high** RPM score do better, and this is supported by the six significant differences ( $P < 0.1$ ) and their positive polarity. If it is true that students who score high on Raven’s progressive matrices do better with the game than those who score low on RPM, that does not necessarily conflict with the idea that low-scoring students have more to gain from visual immersion. Winn (1997) discovered that otherwise low-achieving students became almost as proficient as the high-achieving students in his experiment, but only with the immersive interface. High-achieving students achieved high scores, regardless of the interface.

We must stress that while the data is provocative, it is not conclusive. There are not enough low P-values in one place to say that we have definitely found an effect, even though the trends were worth discussing. The next step was to cross the RPM scores with the conceptual learning comparisons.

**Table 21.** RPM Scores Crossed With Conceptual Learning

	LowRPM C&D vs. T		HighRPM C&D vs. T		LowRPM vs. HighRPM	
Form	0.5331	+	1.0000	+	0.4635	+
Balance	1.0000	-	1.0000	-	0.4898	-
Royal Power	0.6687	-	<b>0.0168</b>	-	0.3772	+
<b>pave</b>	1.0000	-	0.1151	-	0.3027	+
Public	1.0000	-	0.2077	-	<b>0.0255</b>	+
Festival	0.6570	+	<b>0.0571</b>	+	0.5380	-
Equality	<b>0.0474</b>	+	0.3548	+	0.7416	+
<b>cave</b>	0.2484	+	0.2351	+	0.1983	+
Privacy	0.6146	-	0.3548	-	0.7416	+
Ancestors	0.1782	+	0.4013	+	<b>0.0465</b>	+
Offerings/Sacrifice	1.0000	-	0.2077	-	0.5607	+
<b>have</b>	0.5812	+	0.8375	+	0.0393	+
Secret	1.0000	+	1.0000	+	0.2467	+
Divine Presence	0.4225	+	0.2077	+	1.0000	+
Original Place	0.3564	+	0.4013	+	0.7624	+
<b>save</b>	0.2065	+	0.7671	+	0.3825	+
outside	1.0000	-	0.2800	-	0.3541	+
spaceobj	1.0000	-	1.0000	-	0.2347	+
visverb	<b>0.0064</b>	+	<b>0.0337</b>	+	0.1425	+
spacespace	1.0000	-	0.8862	-	0.1160	+
factviz	<b>0.0504</b>	+	<b>0.0233</b>	+	<b>0.0991</b>	+
elements	0.2589	-	0.2912	-	0.1146	+
concepts	0.7554	+	1.0000	+	0.2347	-
<b>Compave</b>	0.2311	+	0.2812	+	<b>0.0236</b>	+
<b>Overall1</b>	<b>0.0030</b>	+	<b>0.0430</b>	+	<b>0.0370</b>	+
<b>Overall2</b>	<b>0.0149</b>	+	<b>0.0922</b>	+	<b>0.0515</b>	+



From the results in Table 21 and Table 20, we suspect that students with higher RPM scores generally do better with *Gates of Horus* (section 3.3, p98), but we did not test enough students to say that we have produced conclusive evidence of the effect. The “LowRPM vs. HighRPM” in Table 20 (p191) add weak evidence to our belief by having seven individual comparisons statistically significant. The strongest evidence is the fact that the P-values for Compave, Overall1, and Overall2 in Table 21, above, strongly indicate a significant difference. However, their case is weakened by a lack of significant differences in the individual concept and theme questions.

Furthermore, there is probably an interaction effect between the experimental treatment and students’ RPM score. Both Table 20, p191, and Table 21, p194 above, show more individual facts/themes/concepts where the students in the Theater Group did significantly better than all the other students. Also, the values in row “Overall1” in Table 20 shows a lower “P” value for low RPM students than for high RPM students, and so does Overall2. In Table 21, the averages for the low-RPM students show lower P-values than those for higher-RPM students. In short, we believe that the low-RPM score students do in fact have more to gain from the immersive visual condition but that we did not test enough of them to prove it.

When we look at the treatment effect for the lower-RPM-scoring half of the students, we have only approximately seven students in the Theater Group and 15 students in the aggregate Control Group. The same is true when we test the high-RPM scoring students. For higher P-values, there are few students on either side of a comparison which results in more erratic behavior among the P values. There are ways to adjust the P-values to account for this, but we believe we do not have enough data to make these manipulations worthwhile. We regard our findings from the Raven’s Progressive Matrices data crossed with the results from the video data as informative and interesting, but *anecdotal*.

## 5.7 DISCUSSION

By design, the Sanctuary is the smallest and most intimate space of the Virtual Egyptian Temple, but it is also the most complex, unifying all of the major themes of the temple. The smallness and visual complexity of the space also requires the student to search for features (“clues” in the game) in many directions as well as behind the shrine. This conveys a mechanical advantage to students in the immersive condition because they have to spend less time navigating and less time rotating the view. Finally, by the time students reach the Sanctuary, they have had the most time (compared to when they entered other areas) to learn the game and become familiar with the interface. This would tend to decrease the statistical “static” caused by variations in learning speed (of the interface and the game), and allow the main effect of the experimental treatments to come to the fore. Finally, many of the ideas presented in the Sanctuary were directly supported by features in other areas of the Temple. The most important example of this is the idea of Pharaoh and the gods exchanging gifts of bounty and power. It is in fact, the central idea of the Temple as a whole, which is literally designed to focus attention on the divine image in this study.

Evidence suggests, but does not prove, that students who score higher on the RPM tests do better with *Gates of Horus* (section 3.3, p98) , because all students in this study had no more than an hour to both learn and play the game. Students who are more visually oriented were able to figure out the interface and the game itself more quickly and find important features more easily. The same evidence suggests that students with less visual ability shown greater improvement when using the immersive interface. This would be in line with the results found by Winn (1999). Unfortunately, this evidence must be considered anecdotal, because we do not have enough data to produce a statistically conclusive result. This would be an excellent topic for further research.

## 6.0 OTHER MEASURES

In this section we present measures which did not describe statistically useful results, but are instructive nonetheless. Refer to section 3.6, p122, to see all of the tests in this study and the order in which we conducted them.

In data from both the Drawn Map Test for **H4** and the Magnet Map Test for **H5**, we saw no significant differences in performance for the Theater Group versus the other groups, not even a trend in one direction or the other. This is at odds with the virtual reality training literature, which has established that Immersive VR is a good way to teach survey and route knowledge of an area. We conclude that the Temple was too small and too simple for immersion to produce a genuine difference in students' knowledge which could be detected with a mapping test.

We also compared results for the Follow-Up Test, one or two months later, and comparing responses from students in the Theater Group to all the others. Unfortunately, we saw no statistically significant differences, and there were not enough differences in individual scores to be convincing. The Follow-Up Test was very similar to the Post Test, except that students gave much less informative answers on the short-answer questions. We conclude that if there are any lasting comparative benefits to visual immersion over a standard desktop monitor, a standard quiz such as a Follow-Up Test is not sensitive enough to detect it.

This leaves **H3**, **H4** and **H5** unproven.

## 6.1 PRETEST

The pretest queries students on basic demographic information, computer literacy, game literacy, attitudes towards computers, exposure to computer games, and attitudes about Egypt.

Unfortunately, a knowledge pretest which asks specific questions about the Virtual Egyptian Temple is not possible because it would reveal too much information about the temple, giving any student who took it an artificial advantage in any posttest. While all of the comparison groups would have equal advantage, it would still distort the results. It would most likely lead to a ceiling effect, where all students scored so well that there would be little difference between their learning outcomes. A true knowledge pretest for the temple might also cause the students to “over-fit-the-data” attempting to study to the test and only the test, which would hurt the external validity of any results of the experiment.

Therefore we added the Control Group to the experiment. They took the same Post Test (section 4.0 p136) the other groups, but filled it out **before** playing the game. This gave us a measure of how well the average student can use prior knowledge and clever guessing based on the structure of the test itself. In effect, the Control Group’s scores on our Post Test took the place of a knowledge pretest for the other two groups. Instead, the Pretest focuses on demographic and attitudinal questions, which may be useful for later analysis. Table 22, below, summarizes the questions, options, and results. For an exact reproduction of the Pretest, see section Appendix A, p259.

**Table 22.** Pretest Results

How old are you?	
11	25
12	28
13	19
14	5
What grade are you in at school?	
6th	32
7th	28
8th	17
Are you a boy or a girl?	
boy	39
girl	38
How many hours a day do you use a computer?	
none	2
0-1	27
1-3	39
3-6	8
7 or more	1
Do you play computer games?	
yes	71
no	6
On average how many hours a day do you play computer games?	
none	7
0-1	37
1-2	28
2-3	3
4 or more	2
Do you play some computer games that have a three dimensional world?	
yes	50
no	27

Do you play some computer games that have a three dimensional world?	
yes	50
no	27
How do you feel about computers?	
Very bad	0
.	1
.	9
.	26
Very good	41
How interested are you in Ancient Egypt?	
Not Very	3
.	11
.	31
.	21
Very	11
How many times have you visited an Egyptian collection in a museum?	
none	13
one or two	46
three to ten	12
more than ten	6
Have you ever visited the Egypt Hall at Carnegie Museum of Natural History?	
yes	51
no	26
How many books about Ancient Egypt have you looked at?	
none	6
one or two	40
three to five	19
more than five	12

When do you know you are experiencing Virtual Reality? Select all that apply:	
Using a computer	30
Interacting with a three dimensional world	49
Dreaming	23
Seeing the computer animated world all in big wide view sometimes all around you	46
Playing a game	33
Have you ever played a virtual reality game?	
yes	50
no	27
Did you ever play with a virtual reality game or ride at an amusement park or arcade?	
yes	49
no	28
Which of the following do you know something about?	
The Nile River	67
Ramses	26
The Valley of the Kings	25
The Sphinx	44
Scarab Beetles	25

## 6.2 GAME LOGS

*Gates of Horus* records every event in the game for later analysis. To summarize:

1. Every location in the virtual space occupied by the player every fifth of a second. This gave a clear record of where the student is during the time s/he played the game.
2. The length of time the student took to:
  - a. Complete the entire game, from triggering the first recording (“clue”) speech for the Pylon to triggering the final God-Speech declaring the student victorious.
  - b. Complete each Area of the temple, from triggering the first recording to the time the priest opens the gate to the next Area.
  - c. Move from Area to Area, from leaving one Area to triggering the first recording in the next Area. There are three such transitions, Pylon-Courtyard, Courtyard-Hypostyle Hall, and Hypostyle Hall-Sanctuary.
3. For each Area of the temple, the average time the student spent per question.”
4. The number of times the student answered a question **incorrectly**.
5. The number of times the student listened to a recording.

This record of events was very useful during the pilot testing. For the main study, Table [23](#), below, shows the results for the measures we were interested in.

**Table 23.** Results from the Game Logs

Area	Recording	Question	T vs. C&D	
<b>Totals</b>	time	TotTime	0.5480	-
<b>PYLON</b>	time	PTime	0.3563	-
	r-time	TRespAvg	0.1444	+
	Intro	PIntroRec	0.6284	+
		PIntroQ1	0.2593	-
		PIntroQ2	0.8939	-
		PIntroQ3	0.5790	+
		PGoalQ1	0.7454	-
		PGoalQ2	0.3453	-
	Disc	PDiscRec	0.4199	+
		PDiscQ1	0.6895	-
		PDiscQ2	0.3364	-
		PDiscQ3	0.7268	+
	King	PKingRec	0.6076	+
		PKingQ1	0.8560	-
		PKingQ2	0.5598	-
		PKingQ3	0.5339	+
	Hawk	PHawkRec	0.5499	+
		PHawkQ1	<b>0.0601</b>	+
		PHawkQ2	0.2893	-
		PHawkQ3	0.2976	-
<b>T1</b>		PTrans	<b>0.0330</b>	+
<b>COURTYARD</b>	time	CTime	0.2296	-
	r-time	CRespAve	0.2916	+
	Intro	CIntroRec	0.6378	-
		CIntroQ1	0.4408	-
		CIntroQ2	0.3737	-
		CGoalQ1	1.0000	+
		CGoalQ2	0.7056	+
	Column	CColumnRec	0.3082	-
		CColumnQ1	0.6703	+
		CColumnQ2	0.2822	-
	Floor	CFloorRec	0.3538	-
		CFloorQ1	0.5790	+
		CFloorQ2	0.4871	-
	Offering	COffRec	0.6130	-
		COffQ1	0.1953	-
		COffQ2	<b>0.0319</b>	+
	Sky	CSkyRec	0.6499	-
		CSkyQ1	1.0000	+
		CSkyQ2	1.0000	-
	Walls	CWallsRec	0.4405	-
		CWallsQ1	0.3178	+

Area	Recording	Question	T vs. C&D	
		CWallsQ2	0.2974	-
<b>T2</b>		CHTrans	<b>0.0005</b>	+
<b>HYPOSTYLE</b>	time	HTime	0.3525	-
	r-time	HRespTime	0.9333	+
	Intro	HIntroRec	0.2958	+
		HIntroQ1	<b>0.0266</b>	-
		HIntroQ2	<b>0.0369</b>	+
		HIntroQ3	1.0000	+
		HIntroQ4	0.4841	-
		HGoalQ1	1.0000	+
		HGoalQ2	0.2966	-
	Column	HColRec	0.3082	-
		HColQ1	<b>0.0130</b>	+
		HColQ2	1.0000	-
		HColQ3	0.6771	-
	Ceiling	HCeilingRec	0.7731	-
		HCeilingQ1	<b>0.0165</b>	-
		HCeilingQ2	0.1363	-
	Lamp	HLampRec	0.6950	+
		HLampQ1	1.0000	+
		HLampQ2	0.6463	+
		HLampQ3	<b>0.0321</b>	-
<b>T3</b>		HSTrans	<b>0.0020</b>	+
<b>SANCTUARY</b>	time	STime	0.2657	-
	r-time	SRespAve	0.3484	+
	Intro	SIntroRec	<b>0.0392</b>	-
		SGoalQ1	1.0000	-
		SGoalQ2	0.7430	+
		SGoalQ3	0.7140	+
	Idol	SIdolRec	0.6339	+
		SIdolQ1	1.0000	-
	Floor	SFloorRec	0.2609	+
		SFloorQ1	1.0000	+
		SFloorQ2	1.0000	+
		SFloorQ3	0.6399	+
	Shrine	SShrineRec	0.2623	-
		SShrineQ1	1.0000	-
		SShrineQ2	0.3964	-
		SShrineQ3	0.5624	+
	Wall	SWallRec	0.2755	-
		SWallQ1	0.2058	+
		SWallQ2	0.6817	+
		SWallQ3	0.8189	+



Table 23, above, the first column indicates the Area of the Temple to which the measures for all the rows until the next Area apply. For example, the priest for the Pylon area asked the question “PKingQ1.” There are also three transition periods, T1, T2 and T3, from the time the Gates to an area open, to the time the student triggers the introductory recording in that Area. In rows where the **second** column shows “time,” it refers to a comparison between how long it took students in the Theater Group to complete the area/transition compared to the time for all other students. Where there is the name of a recording in column 2, the value in that row refers to the number of times Theater Group students listened to that recording, compared to the number of times all other students listened to it. Finally, in any row with column 2 blank, the value in that row refers to a comparison between the number of times students in the Theater Group got a particular question (named in column three) wrong before getting it right and the number of times all other students got the question wrong before getting it right before *they* finally got it right.

Column 3 has the actual names of the areas, transitions, recordings and questions.

The **fourth** column shows the Mann-Whitney test P-value of a comparison between performance by students in the Theater Group versus students in the other two groups on each question or recording. Values less than 0.1 are indicated with boldface type, because they have some measure of statistical significance. The **fifth column** shows (indirectly) *which* group did better.

For example, in a row with a question, the performance measure is the average of how many times all students in a comparison group answered a question incorrectly with low being good, obviously. So, for question “COffQ2,” the fifth column shows a “+” sign, meaning that the Theater Group did better, *on average*, than the combined Controls and Desktop Group. The P value is 0.0319, which means that there is only a 3.19% chance that the difference in average number of wrong answers is just a random event. For time measures the P-value is based on which comparison group finishes the area or transition more quickly, on average. For the recordings, we compare on the average number of times the student hears the recording.

As you can see, not many of the P-Values are even mildly significant ( $P < 0.1$ ) and those that are, tend to cancel each other out because they have opposite polarity. The only clear pattern that emerges is that the transition times are slower for students in the immersive condition. This is probably due to differences in the way the action of the controller (the Gyromouse) relates to the display (section 3.3.1, p99). We make no other conclusions from this data.

### 6.3 PRESENCE AND COMFORT TEST

The Presence and Comfort test was a short written questionnaire we gave to the Theater Group students, immediately after they played the learning game. Most of the questions on it are from Kennedy's questionnaire for motion sickness (Kennedy, 1992). Also, the first question measured the student's degree of *presence* (section 2.5.3, p47) in the virtual temple using an adaptation of Hunter Hoffman's questionnaire for Presence (Hoffman, 1999). Figure 41 is a condensed image of the test form.

Table 24, below, shows the full results of the test. We tested for a difference in students' self-reported sense of Presence (third column) between students in the Theater Group (T) and students in the other two groups (C & D). A two-tailed uneven-samples T-Test yielded  $P = 0.6087$ , which indicates no evidence of any difference between students in the two conditions. It could be that the test is not sensitive enough, but we think that it more likely that students in the two conditions really did have similar levels of presence. The Earth Theater does not have the same degree of sensory immersion found in a Stereoscopic CAVE or an HMD used in conducting most Immersive VR experiments. Also, a single rating of presence confounds the effects of sensory and thematic presence. We draw no conclusion from the presence data.

The responses to questions from the Kennedy (1992) questionnaire showed very little self-reported motion sickness—not enough to have had much of an effect. Given the lack of complaints over the long history of the Earth Theater's operation, we expected this, but we had to test for it. We surmise that this is a result of the narrow vertical field of view, the relatively low light intensity of the display, and the availability of a floor-attached seat to the user.

## Presence and Comfort Test

Student Code: \_\_\_\_\_

While you were playing the game, to what extend did you feel you were *inside* the Egyptian temple. Please pick a number answer, on a scale of zero to ten, based on the key below

- 0 = I did NOT feel like I was inside the temple, at all.
- 1-4 = Maybe I felt like I was in the temple, but only a little.
- 5-6 = I did kind of feel like I was in the temple.
- 7-9 = I had a strong feeling of being inside the temple.
- 10 = I felt like I was totally inside the virtual temple.

Your answer \_\_\_\_\_

For each questions, please select the answer that applies

Do <b>you</b> feel sick?	No	A little	A lot
Does your head hurt?	No	A little	A lot
Do your eyes hurt?	No	A little	A lot
Do you have an upset stomach?	No	A little	A lot
Are you dizzy with your eyes open?	No	A little	A lot
Are you dizzy with your eyes closed?	No	A little	A lot
Are you burping at all?	No	A little	A lot

**Figure 41.** Presence and Comfort Test

**Table 24.** Results from the Presence and Comfort Test

		<b>Presence</b>	Do you feel sick?	Does your head hurt?	Do your eyes hurt?	Do you have an upset stomach?	Are you dizzy with your eyes open?	Are you dizzy with your eyes closed?	Are you burping at all?
Anna	C	10	No	No	No	No	No	No	No
Bam82	C	10	No	No	No	No	No	No	No
Cameron	C	8	No	No	No	No	No	No	No
Chuckles	C	8	No	A lot	A Little	No	No	No	No
Commando	C	7	No	No	No	No	No	No	No
FibMaster	C	4	No	No	No	No	No	No	No
Icarus13	C	8	No	No	No	No	No	No	No
KimKim	C	5	No	A Little	No	No	No	No	No
KingTut	C	0	No	No	No	No	No	No	No
Margarita	C	6	No	No	No	No	No	No	No
Redhawk1787	C	9	No	No	No	No	No	No	No
Renee	C	4	No	No	A Little	No	No	A Little	No
Skizzy	C	8	No	No	No	No	No	No	No
Spicy44	C	7	No	No	No	No	No	A Little	No
The	C	3	No	A Little	No	No	No	No	No
TRCB	C	9	No	No	No	No	No	No	No
ALG	D	8	A Little	No	No	A Little	No	No	No
Bubbles	D	0	No	A Little	A Little	No	A Little	A Little	No
Grechen	D	7	No	A Little	A Little	No	A lot	A Little	A Little
Gumball	D	10	No	No	No	A Little	No	No	No
Jen	D	8	No	No	No	No	No	No	No
Mara	D	10	No	No	No	No	No	No	No
Milky	D	7	No	No	No	No	No	No	No
MoneyBags	D	10	No	No	No	No	No	No	No
Noah	D	7	No	No	No	No	No	No	No
SSSS	D	3	A Little	No	A Little	No	No	No	A Little
StarFire	D	0	No	No	No	No	No	No	No
Twister22	D	9	No	No	No	No	No	No	No
Vivi	D	7	No	No	No	A Little	No	No	No
Whatever	D	8	No	No	No	No	No	A Little	No

		<b>Presence</b>	Do you feel sick?	Does your head hurt?	Do your eyes hurt?	Do you have an upset stomach?	Are you dizzy with your eyes open?	Are you dizzy with your eyes closed?	Are you burping at all?
Ace	T	4	No	A Little	A Little	No	A Little	No	No
Beaver32	T	10	No	No	No	No	No	No	No
Bman	T	1	No	No	No	No	No	No	No
Champ	T	9	A Little	A Little	No	A Little	A Little	No	No
Claire	T	10	No	No	No	No	A Little	No	No
HarpsichordDude	T	9	No	A Little	No	No	No	A Little	No
JSS	T	10	A Little	No	No	A Little	A Little	No	No
Kimiko	T	10	No	A Little	No	No	No	No	No
Magma1000	T	8	No	No	No	No	No	No	No
Morgan	T	7	No	No	No	No	No	No	No
MrBeans	T	3	No	No	No	No	No	No	No
Natalie	T	8	No	A Little	No	No	No	No	No
Nellie	T	0	A Little	A Little	No	A Little	No	No	No
NicelyNicely	T	6	A Little	A Little	No	No	No	No	No
Paris	T	8	No	No	No	No	No	No	No
PinkySprinkles	T	0	A Little	A Little	A Little	No	No	A Little	No
Pumpkin	T	8	No	No	No	No	No	No	No
Set	T	2	No	No	No	No	No	No	No
Shadow	T	8	No	No	No	No	No	No	No
Sparky	T	7	No	No	No	No	No	No	No
Superman	T	8	A Little	A Little	A Little	No	No	No	No
TreeHugger	T	7	No	No	No	No	No	No	No
Vegitomsn	T	6	No	No	A Little	No	No	No	No
Zulu1138	T	0	No	A Little	No	No	No	No	No

## 6.4 DRAWN MAP

During the game, students learned the structure and appearance of the Temple by navigating through it and interacting with the spotlighted (Figure 26, p110) features and the priest. While developing a good *cognitive map* (Johns, 2002; Darken, 2001) of the temple was valuable in itself, it was also crucial as the organizing structure for the facts the student needed to learn and as a cognitive tool for understanding the required concepts. For this, the student requires *survey knowledge* of the temple, with the acquisition of *route knowledge* useful primarily as an intermediate step (Koh, 1999). Virtual environments are an effective means to teach students how to recognize and navigate (analog) real spaces (Darken, 2001; Durlach, 2000). Therefore we believe our use of a virtual environment to describe the temple was effective.

Each student drew at least two maps in his or her testing booklet using provided pencils with erasers. The first map represented the actual room the student was in, the table or desk where s/he was sitting and the door into the room. The second map was a map of the temple: a simple floor plan showing the major objects located within the temple. This is a very common method of testing students' survey knowledge of navigable spaces and is widely used in VR studies (Johns, 2002; Goerger, 1998; Gabrielli, 2000; Miller, 2002; Arthur, 2001). However, mapping is a skill that some children are never taught. If the test subjects did not know how to draw a map, this test was a poor indicator of their spatial knowledge of the Temple. Having each student draw the room in which s/he was sitting was intended to indicate whether that student had any mapping skill.

We photographed all the maps for later analysis. Figure 42, below, shows a sample temple map and a sample room map.

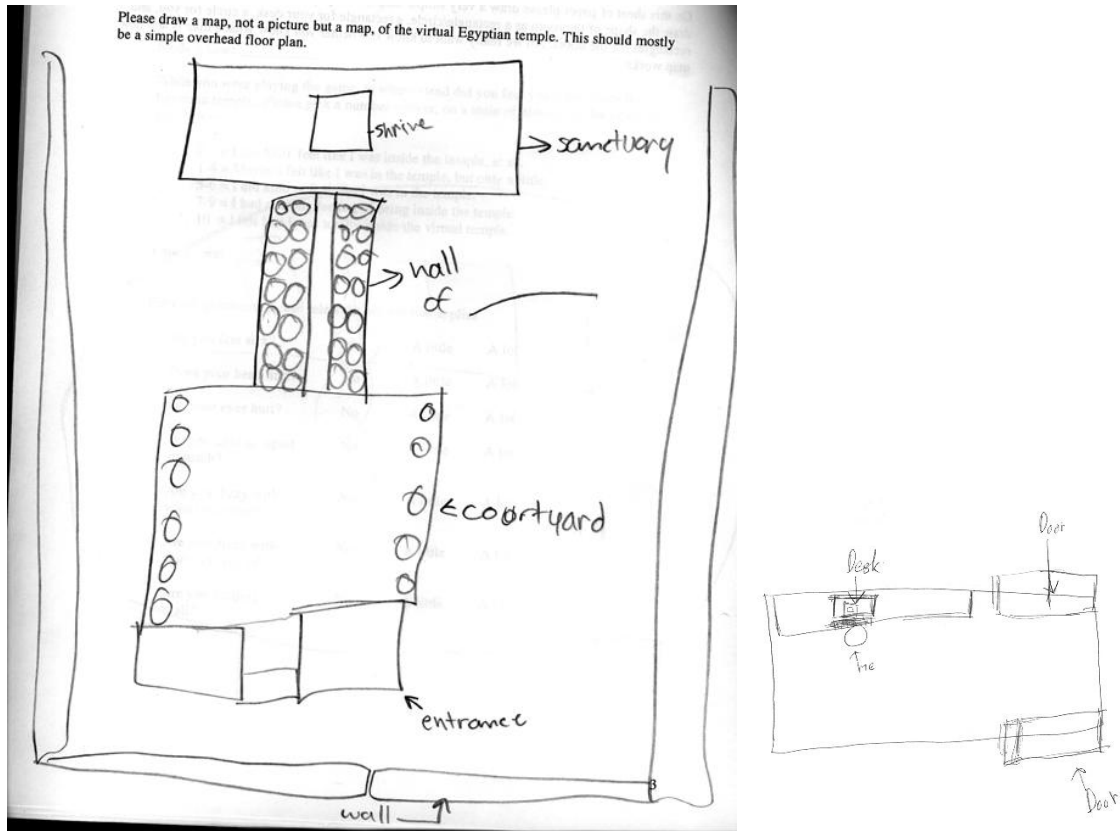

**Figure 42.** Sample Drawn Temple Map (left) and a sample Drawn Room Map (right).

Graders evaluated the drawn maps using an online grading form, summarized in Table 25, below. You can see a reproduction of the form in Appendix A, p259.

Two graders (Getkin and Vadnal) evaluated the student-made magnet maps using the grading form described in Table 25, below. We conducted the interrater reliability analysis and hypothesis testing in very nearly the same way as we did for the Video Test (section 4.4, p144). We report our results in Table 26, p213.

**Table 25.** Drawn Map Grading Form Questions.

Grader Name				
student code name				
		Yes	No	
	Did the student indicate that the temple is a building with an inside and an outside?	.	.	
	Did the students draw or indicate where the front of the temple is?	.	.	
	Did the student actually draw the Pylon	.	.	
	Did the student draw a room that is recognizable as the Courtyard?	.	.	
	Did the student draw room that is recognizable as the Hypostyle Hall?	.	.	
	Did the student draw room that is recognizable as the Sanctuary?	.	.	
	Did the student draw the shrine?	.	.	
	If the student drew the shrine, is it correctly placed?	.	.	
	Are the rooms of the temple connected?	.	.	
	Are the rooms of the temple correctly ordered?	.	.	
	Are the hawk statues indicated?	.	.	
	Did the student draw one or more priests?	.	.	
	Are at least some of the oil lamps indicated?	.	.	
	is the divine image of the god indicated?	.	.	
Looking at the student's map, rate how well the rooms are proportioned with respect to each other.	Exactly Correct	Essentially Correct	Mediocre	Out of proportion



		The Courtyard	The Hypostyle Hall	The Sanctuary
Describe the columns as the student drew them. Check all that apply. The student drew...	the correct number of columns - The Courtyard	.	.	.
	the correct number of columns - The Hypostyle Hall	.	.	.
	the correct number of columns - The Sanctuary	.	.	.
	the correct number of rows of columns - The Courtyard	.	.	.
	the correct number of rows of columns - The Hypostyle Hall	.	.	.
	the correct number of rows of columns - The Sanctuary	.	.	.
	some rows of columns are in the correct location - The Courtyard	.	.	.
	some rows of columns are in the correct location - The Hypostyle Hall	.	.	.
	some rows of columns are in the correct location - The Sanctuary	.	.	.
	some rows of columns are in the wrong location - The Courtyard	.	.	.
	some rows of columns are in the wrong location - The Hypostyle Hall	.	.	.
	some rows of columns are in the wrong location - The Sanctuary	.	.	.
	opposing ranks of columns are different in number - The Courtyard	.	.	.
	opposing ranks of columns are different in number - The Hypostyle Hall	.	.	.
	opposing ranks of columns are different in number - The Sanctuary	.	.	.

Comparing the number of columns in the Hypostyle Hall versus the Courtyard.	The Hypostyle Hall is shown with more columns than the Courtyard.	Both rooms are shown with the same number of columns.	Both rooms have NO columns at all.	the Courtyard is shown with more columns than the Hypostyle Hall.
How many features of the temple are correctly labeled?	<i>(open ended)</i>			
How many features of the temple are correctly described in a general way? for example of students may use "statue" to describe the divine image of the god in the shrine.	<i>(open ended)</i>			
how many features of the temple are Mislabeled?	<i>(open ended)</i>			
Do you wish to say anything else anything else about theism student's drawing of the temple?	<i>(open ended)</i>			

**Table 26.** Results for Student Drawn Maps

Question	Short Name	Fleiss Kappa error	P-values
Did the student indicate that the temple is a building with an inside and an outside?	inout	<b>0.0000</b>	0.9103
Did the students draw or indicate where the front of the temple is?	front	<b>0.0000</b>	0.8137
Did the student actually draw the Pylon	Pylon	<b>0.0000</b>	0.3884
Did the student draw a room that is recognizable as the Courtyard?	court	<b>0.0004</b>	0.5284
Did the student draw room that is recognizable as the Hypostyle Hall?	hypo	<b>0.0069</b>	0.8364
Did the student draw room that is recognizable as the Sanctuary?	Sanctuary	<b>0.0041</b>	0.1251
Did the student draw the shrine?	shrine	<b>0.0000</b>	0.2981
If the student drew the shrine, is it correctly placed?	shrineplace	<b>0.0000</b>	0.0382
Are the hawk statues indicated?	hawks	<b>0.0000</b>	0.5362
Did the student draw one or more priests?	priests	<b>0.0000</b>	0.9416
Are at least some of the oil lamps indicated?	lamps	<b>0.0000</b>	0.5582
is the divine image of the god indicated?	divineimage	<b>0.0000</b>	0.4610
Looking at the student's map, rate how well the rooms are proportioned with respect to each other.	proportions	<b>0.0001</b>	0.1252
Describe the columns as the student drew them. Check all that apply. The student drew...	courtcolnum	<b>0.0041</b>	0.5442
the correct number of columns - The Courtyard			
the correct number of columns - The Hypostyle Hall	hypocolnum	<b>0.0041</b>	0.1008
the correct number of rows of columns - The Courtyard	courtcolrows	<b>0.0004</b>	0.4568
the correct number of rows of columns - The Hypostyle Hall	hypocolrows	<b>0.0000</b>	0.8790
some rows of columns are in the correct location - The Hypostyle Hall	hypocolloc	<b>0.0000</b>	0.3477
some rows of columns are in the wrong location - The Courtyard	courtcolloc	<b>0.0024</b>	0.1598
some rows of columns are in the wrong location - The Hypostyle Hall	hypowrong	<b>0.0001</b>	0.0495
some rows of columns are in the wrong location - The Sanctuary	sancwrong	<b>0.0000</b>	0.8542
opposing ranks of columns are different in number - The Courtyard	courtwrong	<b>0.0000</b>	0.7774
opposing ranks of columns are different in number - The Hypostyle Hall	hypowrong	<b>0.0000</b>	0.5194
How many features of the temple are correctly labeled?	labels	0.7900	

The fourth column in Table 26, above, shows that grader responses were in substantial agreement for all evaluated aspects of the map, except for “labels” in the last row. The P-value is greater than 0.1, which is unacceptable, but all of the other aspects passed, so we could apply the hypothesis test. Among those that passed, only two of the Mann-Whitney P-Values reported in the last column of Table 26 were less than 0.1, “hypowrong” and “shrineplace.” This is probably a random event, given that all of the others are greater than 0.1, indicating **no** evidence of a significant difference. Therefore, we can conclude nothing from this data.

Also, we had intended to use the room maps (Figure 42, p209) as an additional test for the validity of the main drawn maps data. However, most of the room maps appeared to us to be correct, with very few being dysfunctional. We did not believe it would be worthwhile to evaluate them in detail.

## 6.5 MAGNET MAP

We gave each student an accurate map (floor plan) of the temple, and a collection of *chits*, small bits of magnetic paper, each with the image of some feature of the temple. The student attempted to place the chits in the appropriate locations on the map to indicate the locations of the corresponding features. The map was glued to a metal sheet and the chits were printed on a flexible magnetic material. When the student was done, we photographed the map for later evaluation. The goal of this test was to determine how well the student remembered the placement of important features within the space.

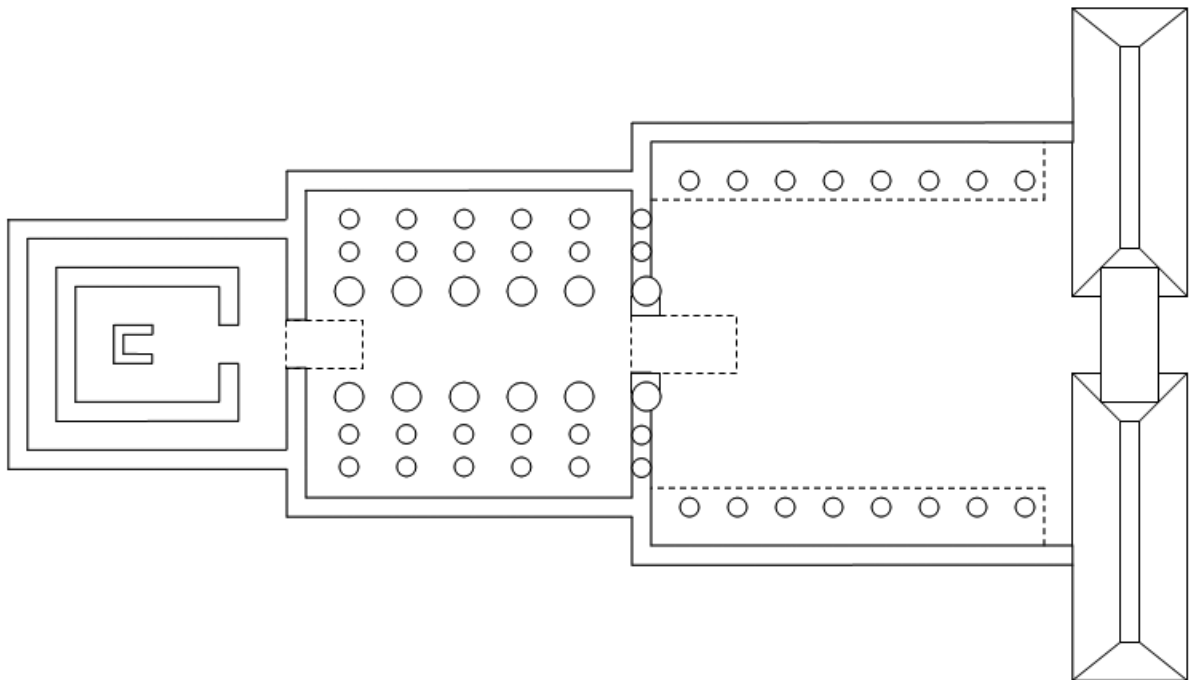

**Figure 43.** Blank Map of the Temple



**Figure 44.** Magnetic Cutouts

**Table 27.** Magnet Map Grading Form Questions.

grader name							
student code name							
		<b>Correctly Placed</b>	<b>On the correct wall or ceiling/floor</b>	<b>In the correct room.</b>	<b>In the wrong room.</b>	<b>Not Placed</b>	
Single Location Items	shrine	.	.	.	.	.	
	ceiling hawks	.	.	.	.	.	
	purification scene	.	.	.	.	.	
	offering scene	.	.	.	.	.	
	HYPOSTYLE floor	.	.	.	.	.	
	Courtyard floor	.	.	.	.	.	
	Khunm	.	.	.	.	.	
	Pharaoh Offers	.	.	.	.	.	
	boat scene	.	.	.	.	.	
Items Identical or Similar to Others in Different Locations	priest	.	.	.	.	.	
	archway	.	.	.	.	.	
	hawk one	.	.	.	.	.	
	hawk two	.	.	.	.	.	
	lamp one	.	.	.	.	.	
	lamp two	.	.	.	.	.	
	winged disk one	.	.	.	.	.	
	winged disk two	.	.	.	.	.	
	winged disk three	.	.	.	.	.	
	winged disk four	.	.	.	.	.	
	winged disk five	.	.	.	.	.	

	winged disk six	.	.	.	.	.	
	winged disk seven	.	.	.	.	.	
Location for Pharaoh Smites to the Right	correctly placed	on the Pylon where "smites to the left" should be	elsewhere on the exterior	in the Courtyard	in the Hypostyle Hall	in the Sanctuary	not placed
Location for Pharaoh Smites to the Left	correctly placed	on the Pylon where "smites to the right" should be	elsewhere on the exterior	in the Courtyard	in the Hypostyle Hall	in the Sanctuary	not placed
the flags	on the Pylon, correctly placed	on the Pylon reversed	elsewhere notes in or on the temple	not placed			
Horus grants authority	correctly placed	on the Pylon where Osiris should be	elsewhere on the exterior	in the Courtyard	in the Hypostyle Hall	in the Sanctuary	not placed
Osiris grants authority	correctly placed	on the Pylon where Horus should be	elsewhere on the exterior	in the Courtyard	in the Hypostyle Hall	in the Sanctuary	not placed
Is there anything you want to say about this students magnet map?							

Two graders (Getkin and Vadnal) evaluated the student-made magnet maps using the grading form described in Table 27, above. We conducted the interrater reliability analysis and hypothesis testing in nearly the same way as we did for the Video Test (section 5.3, p163). We report our results in Table 28, below. We reproduced the actual grading form in Appendix A, p268



**Table 28.** Results of the Magnet Map Test

<b>Name</b>	<b>IRR P or R Value</b>	<b>T vs. C&amp;D</b>
shrine	<b>0.0000</b>	0.5387
ceiling hawks	<b>0.0000</b>	<b>0.0794</b>
purification scene	<b>0.0227</b>	0.6354
offering scene	<b>0.0001</b>	0.4291
HYPOSTYLE floor	<b>0.0021</b>	0.1701
Courtyard floor	<b>0.0000</b>	0.2766
Khunm	<b>0.0000</b>	0.4349
Pharaoh Offers	<b>0.0018</b>	0.8330
boat scene	<b>0.0000</b>	0.8909
priest	<b>0.0000</b>	0.8680
archway	<b>0.0000</b>	0.8903
hawk one	<b>0.0000</b>	0.5599
hawk two	<b>0.0000</b>	0.2805
winged disk two	<b>0.0000</b>	0.4995
winged disk three	<b>0.0000</b>	0.9758
winged disk four	<b>0.0005</b>	0.7814
winged disk five	<b>0.0001</b>	0.4789
winged disk six	<b>0.0000</b>	0.9949
winged disk seven	<b>0.0000</b>	0.3292
<i>Location for Pharaoh Smites to the Right</i>	<i>0.8963</i>	<b>0.0185</b>
<i>Location for Pharaoh Smites to the Left</i>	<i>0.8924</i>	<b>0.0383</b>
the flags	<b>0.0000</b>	0.3055
<i>Horus grants authority</i>	<i>0.8837</i>	0.6491
<i>Osiris grants authority</i>	<i>0.7606</i>	0.4467

In Table 28, for each feature, the second column contains the output of a test for interrater reliability between the graders. Grader evaluation for four of the features required answering a seven-level Likert scale. We recoded the data into numbers, the resulting scores produced by each grader had seven levels and were reasonably close to normally distributed. Therefore, we used Pearson's-R, a parametric test, to produce the "R-value" in column "IRR P or R Value." Given that we have 52 students, we needed an R-value of 0.273 for there to be a 95% chance that the two sets of data (Vadnal's Grades and Getkin's grades) are truly correlated (Hall, 1998). With the lowest R value (for "Osiris grants authority") being 0.7606, all four passed the interrater reliability test. We performed all other interrater reliability calculations Fleiss Kappa (King, 2004), and reported the error P-Value in the same column. All are less than 0.1, so all passed, meaning we considered the data for their associated temple features in the hypothesis test.

The third column contains the output of the hypothesis test for each feature. For the four features graded on the second level Likert scale, the t-test (two-tailed, uneven sample sizes) was most appropriate. We evaluated the data for all of the other features using the Mann-Whitney test. Both tests produce a P-value, which one can interpret in the same way. Data analysis for all features showed only three cases where students in the Theater Group did better than students in the Control and Desktop Groups, taken together. The significant difference found for the two "Pharaoh smites..." scenes may be due to the students in the immersive condition tending to keep their viewpoint closer to the front of the Temple. The other semi-significant difference found ("ceiling hawks") is most likely a random event, because it is so isolated.

We concluded nothing from this data.

## 6.6 FOLLOW-UP TEST

### 6.6.1 Description

When a student completed the testing at the earth theater, we gave the student a booklet, (Appendix C, p321) which contains more information that elaborates on Egyptian and contextualizes the temple. It also contains links to relevant external resources. One to two months later, we tested the student again for his or her knowledge of the Temple and some of what s/he may have learned from the booklet or elsewhere.

Questions on the Follow-Up test are in three general categories (1) those which are questions from the Post Test but are often rephrased (2) questions and require knowledge from the booklet and (3) questions requiring knowledge from both. Our goal was to test retention, outside learning, and synthesis. Questions required responses that varied from simple, factual answers to slightly more complex and conceptual answers.

Question Q5 (see Table 29, below) appears on the test as a matrix, where the student chooses among pre-defined answers to rate the frequency of his or her recent involvement in Egypt-related activities. See Appendix A, p259 for a reproduction of the actual test.

**Table 29.** Follow-Up Test Questions

Question	Short Name
Q1. What is your secret name?	name
Q2. Do you remember playing a learning game ( <i>Gates of Horus</i> ) on the computer with an ancient Egyptian temple? Select one:	tell
Yes	
Maybe	
No	
Q3. How many people did you tell about <i>Gates of Horus</i> ? Select one:	Thebook
Nobody	
1-3	
4-10	
more than 10	
Q4. Just before you left the museum, we gave you a little book about the Temple (the one in the game). Did you read it? Select one:	abook
No.	
I looked at the pictures	
Yes, I read it.	
I read it carefully and more than once.	
Q5. In the past month, did you see or play with anything else about ancient Egypt? Please select all that apply, if any. (Once, Two or Three Times, Lots)	movie
Read part of a book about Egypt.	abook
Saw a movie about Egypt.	movie
Saw a show on TV about Egypt	TV
Went to the library to look at Egypt books	library
Talked to somebody who knows Egypt.	talked
Saw a website about Egypt.	website
Played a game about Egypt.	game
Made something about Egypt	made
Q6. Did you become interested in any of the activities, above, from playing <i>Gates of Horus</i> ? Select one:	Interest1
No, not at all.	
I would have done these things, anyway. Playing the game didn't make any difference.	
I did some or all of these activities, because I became more interested in Egypt when I played <i>Gates of Horus</i> .	
Q7. Did playing the game, <i>Gates of Horus</i> make you any more interested in learning about Egypt? Select one:	Interest2
No, and I'm not interested in ancient Egypt.	
I'm already interested in ancient Egypt and the game didn't make any difference.	
I am more interested in ancient Egypt, now, because of the game.	
Q8. Did you actually made something Egyptian or about Egypt? Please tell us what it was. (open	

ended)	
Q9. What were the four main areas or pieces of the temple? Check all that apply.	
Pylon	Pylon
Nylon	nylon
Forecastle	forecastle
Sanctuary	Sanctuary
Dining Hall	dining
Hypostyle Hall	hypo
Courtyard	Courtyard
Dome	dome
Q10. There were "spirit forms" of Hawks on the ceiling of the Hypostyle Hall. Where did they lead? Select One:	Hawks
Into the temple.	
Out of the temple.	
To the restroom.	
Q11. In Egyptian belief, what would cause the gods to bless Egypt with good fortune? Select ALL that apply:	
The devotion of the people.	popdevo
Offerings from Pharaoh to the gods.	pharaoh
Ceremonies performed by Pharaoh or the High Priest	ceremonies
Nothing. The gods blessed Egypt, regardless	nothing
Q12. What symbol represented creation, life and especially protection? Select one:	symbol
The Hawk statues.	
The Winged disk above most door.	
The flagpoles.	
The lamps.	
Q13. Did the roof of the Hypostyle Hall have square holes in the ceiling? Select one:	roof
Yes	
No	
Q14. Like many of the real temple ruins in Egypt, most of the temple does not have much color. Why? Select one:	nocolor
It's supposed to be that way.	
Over the centuries, the colors were worn away.	
The Egyptian government spray-painted all the ruins with the sandy/gold color you see.	
Q15. When Pharaoh went before the gods with his offerings and so on, who was he representing? Whose interests was he looking out for? Select one:	represent
The Egyptian people.	
Himself	
People who were devoted enough to worship in the Hypostyle Hall	
Q16. What was the important symbol above all of the doorways in the temple? (open ended)	
Q17. The Shrine in the Sanctuary was. Select ALL that apply:	
A magical gateway to heaven.	gateway

The place where the sacred image (statue) of the god stood.	stood
The point from which the blessings of would flow outward to the land of Egypt.	blessings
Adorned with all the sacred symbols in the other rooms.	adorned
Q18. Some of the main areas of the temple are open and sunny (outdoor) while others are dark and mysterious (indoor). For each major area named on the left, select the box which applies. (Outdoor, Indoor)	
Pylon	pout, pin
Courtyard	cout, cin
Hypostyle Hall	bout, bin
Sanctuary	sout, sin
Q19. What does the Pylon tell us about how the Egyptians wanted the world to be like? (open ended)	
Q20. What was the Courtyard for? What did people do here? (open ended)	
Q21. In the Hypostyle Hall, what do the columns represent and why? (open ended)	
Q22. How did the Sanctuary compare with the rest of the temple? (open ended)	
Q23. The temple in our game, <i>Gates of Horus</i> , did not actually exist in Egypt. We made it from parts of which real temple or temples? Select all that apply:	parts
The mortuary temple of Medinet Habu	
The temple at Abu Symbel.	
The cult temple of Horus in the town of Edfu.	
The palace of the Scorpion King	
Q24. The Egyptians recognized three seasons. What were they? Select ALL that apply:	season
Spring, Summer and Fall	
Flood, Growth and Drought	
Earth, Wind and Fire	
Planting, Harvest, Fallow	
Q25. Where is Egypt? Select ALL that apply:	
Northern Africa,	nafrica
bordering the Mediterranean Sea	med
between Libya and the Gaza Strip	libgaza
and the Red Sea north of Sudan	redsudan
Q26. Why was the temple the only building to be made of stone in a town? Select One:	stone
The Egyptians built everything from stone.	
So it would be eternal and last forever.	
The Egyptians believed that stone was the flesh of the gods.	
Q27. What did Egyptians do in the daily lives that helped unify them as a people. Select ALL that apply:	
Connecting with the gods/goddesses where they lived.	gods
Remembering to honor their ancestors.	ancestors
Reading the Egyptian Bible every day.	bible
Celebrating good fortune and harvests.	celebrate

Drinking beer.	beer
Honoring the King and the great nobles of their cities.	honoring

## 6.6.2 Grading

While multiple-choice questions can be scored automatically, the short answer questions require human judgment. To report his or her judgment on each student's short answer questions, the grader filled out the Post Test Grading form (online) for that student.

Multiple-choice questions, such as Q7, show the original question on the next line, the student's response (remember that the grading forms are individualized) and the grader's available options listed to the right. Open-ended questions, where the student writes the short answer are indicated as such in the second column. See Appendix A, p303, for a reproduction of what the test actually looks like.

**Table 30.** Follow-Up Grading Form

Q1. Grader Name	<i>(open ended)</i>		
Q2. Did you actually make something Egyptian or about Egypt? Please tell us what it was.	<i>(open ended)</i>		
<student answer> (strongly disagree, disagree, neutral, agree, strongly agree)	Did the student make something relevant to Egypt?	Was it somehow related to the virtual temple in our game?	that it sound like a worthwhile activity?
Q3. What was the important symbol above all of the doorways in the temple?			
<student answer> none, half, full			
Q4. What does the Pylon tell us about how the Egyptians wanted the world to be like?			
<Student Response> (none, half, full)	Orderly	Ruled by Egypt	Pharaoh rules Egypt
	Pharaoh has the support of the gods	Other1	Other2



Q5. What was the Courtyard for? What did people do here?			
<Student Response> (none, half, full)	Had great public festivals for everyone	Dressed simply to show their humility before the gods	Brought their best things as offerings
	Gave thanks to the gods as a community	Saw the god and pharaoh (symbolically) embrace in a public way	Saw the connection between heaven and earth symbolized by the open sky of the Courtyard
	Saw how Pharaoh made offerings to the gods on behalf of the people.	Other1	Other2
Q6. In the Hypostyle Hall, what do the columns represent and why?			
<Student Response> (none, half, full)	The primeval marsh at the beginning of time.	The environment when the gods lived on the earth.	The reed houses the Egyptians lived in during the predynastic times.
	Other1	Other2	
Q7. How did the Sanctuary compare with the rest of the temple?			
<Student Response> (none, half, full)	most sacred.	most important.	most exclusive.
	the blessings of heaven originate in the shrine and flow outward through the temple.	the highest ground	other-1
	other-2		
Q8. Please add any additional comments you have regarding student's answers to these questions. Are there any additional concepts that the student entered? Is there a pattern to the student's answers which is not captured by the grading scheme above?	(open ended)		

### 6.6.3 Results

We had hoped that students who learned with the immersive condition would remember more facts and concepts than the others. Unfortunately, our comparisons between all outcomes for the Theater Group versus all outcomes for the Desktop and Control Groups showed no significant differences. As with the Post Test, we surmise that asking questions about simple facts and concepts is not sensitive to the theorized learning advantage provided by immersive condition.

We analyzed the Follow-Up test data in very nearly the same way we analyzed data for the Post Test (section [4.0 p136](#)). We present the results in the following tables with some commentary.

**Table 31.** Interrater Reliability for Short-Answer Question on the Follow-Up Test

Original Question	Concepts the Grader Was Looking For	Short Name	IRR P-value
Did you actually make something Egyptian or about Egypt? Please tell us what it was.	Did the student make something relevant to Egypt?	relevant	<b>0.0000</b>
	Was it somehow related to the virtual temple in our game?	related	0.1101
	that it sound like a worthwhile activity?	worthwhile	<b>0.0000</b>
What was the important symbol above all of the doorways in the temple? _____.	The winged disk.	disk	<b>0.0000</b>
What does the Pylon tell us about how the Egyptians wanted the world to be like?	Orderly	porderly	<b>0.0000</b>
	Ruled by Egypt	pruled	<b>0.0000</b>
	Pharaoh rules Egypt	ppharaoh	0.1820
	Pharaoh has the support of the gods	psupport	<b>0.0000</b>
	Other1	pothier1	<b>0.0001</b>
	Other2	pothier2	0.6637
What was the Courtyard for? What did people do here?	Had great public festivals for everyone	cfest	<b>0.0000</b>
	Dressed simply to show their humility before the gods	csimple	<b>0.0000</b>
	Brought their best things as offerings	cbest	<b>0.0000</b>
	Gave thanks to the gods as a community	cthanks	<b>0.0000</b>
	Saw the god and pharaoh (symbolically) embrace in a public way	cembrace	<b>0.0126</b>
	Saw the connection between heaven and earth symbolized by the open sky of the Courtyard	csky	0.8567
	Saw how Pharaoh made offerings to the gods on behalf of the people.	cofferings	<b>0.0394</b>
	Other1	cother1	0.5862
	Other2	cother2	0.9284
In the Hypostyle Hall, what do the columns represent and why?	The primeval marsh at the beginning of time.	hmarsh	<b>0.0000</b>
	The environment when the gods lived on the earth.	hearth	0.3145
	The reed houses the Egyptians lived in during the predynastic times.	hhouses	<b>0.0266</b>

Original Question	Concepts the Grader Was Looking For	Short Name	IRR P-value
	Other1	hother1	<b>0.0000</b>
	Other2	hother2	0.3811
How did the Sanctuary compare with the rest of the temple?	most sacred.	ssacred	<b>0.0000</b>
	most important.	simportant	<b>0.0000</b>
	most exclusive.	sexclusive	<b>0.0000</b>
	the blessings of heaven originate in the shrine and flow outward through the temple.	s blessings	<b>0.0000</b>
	the highest ground	shighest	0.9284
	other-1	sother1	<b>0.0000</b>
	other-2	sother2	<b>0.0000</b>

Similarly to the Post Test results, most of the Follow-Up test results survived interrater reliability analysis, as shown in the table above. Unacceptable Fleiss Kappa scores are shown in boldface type in Table 31, above. The only difference being that the most of the “other” columns survived, so we included them in.

Table 32, below, shows the results of using the Mann-Whitney test to compare Theater Group students’ grades with the grades for students in the other two groups taken together. The comparison shows only two individual concepts where the Theater Group appeared to do better than the others. These are probably random events, because all the other comparisons are non-significant, including the averages. Also, students earned very few total points for these two concepts, which suggests that the apparent significant difference is really a random event. We conclude nothing from this data.

**Table 32.** Follow-Up Test Grader Reports Hypothesis Test

Short Name	C&D vs. T		Total Points	Short Name	P-value		Total Points
relevant	0.6863		20.94	tell	0.3833	-	19.83
worthwhile	0.8519		19.38	thebook	0.2350	+	13.88
pdisk	0.1475		34.75	abook	0.1812	-	17.21
porderly	0.0340	+	8.88	movie	0.0178	-	8.92
pruled	0.9959		6.75	TV	0.9038	+	7.59
psupport	0.2424		1.00	library	0.1961	-	7.92
pave	0.2310		10.40	talked	0.5682	-	12.94
cfest	0.3490		32.25	website	0.3530	-	10.25
csimple	0.8087		2.25	game	0.8418	+	9.59
cbest	0.9822		7.63	made	0.3145	-	11.6
cthanks	0.5556		8.63	interest1	0.3750		0
cembrace	0.4669		0.50	interest2	0.1490		0
cofferings	0.7475		0.50	pylon	0.3258	-	35
cave	0.1760		8.63	nylon	0.6780	+	41
hmarsh	0.5595		3.00	forecastle	1.0000	+	44
hhouses	0.0347	+	1.38	sanctuary	1.0000	+	46
have	0.1050		2.19	dining	1.0000	-	43
ssacred	0.3032		11.88	hypo	0.2044	+	41
simportant	0.7356		9.25	courtyard	1.0000	-	47
sexclusive	0.7913		18.13	dome	1.0000	+	44
s blessings	0.6159		2.38	hawks	0.3064	-	37
save	0.4192		10.71	popdevo	0.7738	-	26
grandave	0.1201		9.94	pharaoh	0.6780	+	41
pother1	0.9430			ceremonies	1.0000	+	11
cother1	0.7340			nothing	1.0000	+	46
hother1	0.0290			symbol	1.0000	+	28
sother1	0.2340			roof	0.3623	+	42
sother2	0.9360			nocolor	0.4468	-	46
otherave	0.2690						

Similarly, Table 33, below, shows no apparent difference in Theater Group students' grades on the multiple-choice questions versus grades earned by the other students. The only two concepts showing a significant difference have opposite polarity, while many P-values for the other comparisons are high, and there are nearly as many with negative polarity. A comparison result with negative polarity tells us the opposite of what we were expecting – but only if its P-value is less than 0.05. We conclude nothing from this data.

**Table 33.** Multiple Choice Questions Hypothesis Test

Short Name	P-value		Total Points
represents	1.0000	+	40
gateway	0.3742	+	27
stood	0.1794	+	35
blessings	0.5624	+	29
adorned	0.7438	-	35
pout	0.5047	+	35
pin	0.7310	+	36
cout	1.0000	+	46
cin	1.0000	-	45
hout	1.0000	-	47
hin	1.0000	+	46
sout	1.0000	-	47
sin	1.0000	+	46
parts	1.0000	+	40
seasons	0.7339	-	37
nafrica	1.0000	+	37
med	0.3896	-	28
libgaza	0.3419	+	14
redsudan	1.0000	+	22
stone	0.5047	+	35
gods	0.2690	+	39
ancestors	0.4878	+	38
bible	1.0000	-	39
celebrate	0.7583	+	32
beer	0.4468	-	46
honoring	0.0796	+	29

#### 6.6.4 Other Questions

Finally, the online Follow-Up test also asked the student whether playing the game influenced him or her. The affective results shown in Figure 45, are similar to some results from the Post Test (section 4.1, p137).

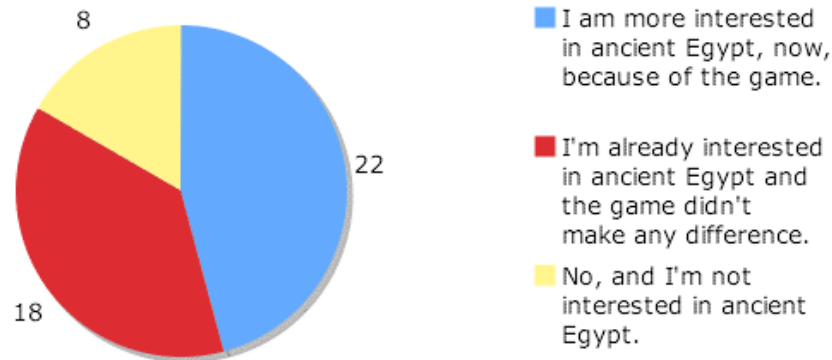

**Figure 45.** Did paying the game, Gates of Horus make you any more interested in learning about Egypt?

Also, as we saw in the Post Test, section 4.5, p148, there was no overall significant difference between students in the Theater Group and all other students. (We used the Mann-Whitney test to compare these results.) Only on P-value is less than 0.05, on question “movie,” and only one other, for “website”, is less than 0.10 These are probably random events, because all the other P-values vary so much.



**Table 34.** Results of Affective Measures in the Follow-Up Test

Question	Short Name	D v T	
How many people did you tell about the Gates of Horus?	tell	0.3833	-
Just before you left the museum, we gave you a little book about the temple (the one in the game) Did you read it?	thebook	0.2350	+
(Did you) Read part of a book about Egypt?	abook	0.1812	-
(Did you) See a movie about Egypt?	movie	<b>0.0178</b>	-
(Did you) See a show on TV about Egypt?	TV	0.9038	+
(Did you) Go to the Library to look at Egypt books?	library	0.4055	-
(Did you) Talk to somebody who knows about Egypt?	talked	0.1966	-
(Did you) See a website about Egypt?	website	<b>0.0904</b>	-
(Did you) Play a game about Egypt?	game	0.8418	+
(Did you) Make something about Egypt)	made	03145	-
Did you become interested in any of the activities above, from playing Gates of Horus?	Interest1	0.3750	+
Did playing the game, Gates of Horus make you an more interested in learning about Egypt.	Interest2	01490	+

As we suggested with the Post Test (4.0 p136), we surmise that all the students were sufficiently excited about the experience to make comparisons between groups difficult for affect questions.

## 7.0 SUMMARY AND CONCLUSION

This study explored whether students benefit from an immersive panoramic display while studying subject matter which is visually complex and information-rich. Specifically, middle-school students learned about ancient Egyptian art and society using an educational learning game, *Gates of Horus*, which is based on a simplified virtual model of an Egyptian temple. First, we demonstrated that the game is an effective learning tool by comparing written post-test results from students who played the game and from students in a no-treatment control group.



**Figure 46.** Virtual Egyptian Temple and the High Priest

Next, we compared learning results of two groups of students who had the same mechanical controls, but one group saw the temple in a visually immersive display (a partial dome) while the others saw it on a standard desktop monitor. The difference appeared when each student gave a verbal show-and-tell presentation of the Temple and the concepts and facts related to it. During that exercise, the student had no cognitive scaffolding other than the virtual temple,

on a small wall projection, which the student navigated during the presentation. The other major tests were questionnaires, which by their nature provide a great deal of scaffolding for the task of recalling the required information. For these tests we believe that this scaffolding aided students' recall to the point where it overwhelmed the differences produced by any difference in the display.

We conclude that the immersive display provides better supports for the student's learning activities for this material. To our knowledge, this is the first formal study to show concrete evidence that visual immersion can improve learning for a non-science topic.

This section summarizes the entire dissertation and contains many links to the main body of the text. We recommend that the reader understand this summary first, and refer to other areas of the dissertation for more detail.

## 7.1 BACKGROUND

Section 2.6, p62 catalogs previous educational research in Immersive Virtual Reality and presents its theoretical underpinnings. Here, we summarize what we learned from that survey and what we set out to accomplish.

Looking for previous studies in the educational use of Immersive Virtual Reality, we find only *twelve* (Rose, 1996; Byrne, 1996; Winn, 1997; Osberg, 1997a; Salzman 1998; Salzman, 1999; Roussos, 1999; Bowman, 1999; Dede, 1999; Jackson, 2000; Winn, 2001; Moreno, 2002a) which used a formal experimental design (Campbell, 1963), and not many more studies which use other formal methods (Roussou, 2006, 2008). We attribute this small number to the historically high cost of the necessary technology, which limited most development in the 1990s to the computer scientists and most applications to the military. Nevertheless, there is still much interest in VR in the educational community, as evidenced by the very large number of Desktop VR applications and learning experiments (Cobb, 2002). Fortunately, the cost of ImmersiveVR is decreasing (Lewis, 2002; Dalgarno, 2002a; Young, 2000; Pivec, 2003b; Bruckman, 2002a; DeLeon, 2000; Tougaw, 2003; Stang, 2003; Jacobson 2005i; CaveUT, 2008), which enabled us to do our study. We believe that this decrease in cost is already leading to more educational research in immersive virtual reality.

### 7.1.1 What is Virtual Reality?

The meaning of the term “Virtual Reality” (VR) continues to evolve and differentiate, as disparate research communities find new ways to use it. We present our own working definition, which we state as criteria:

- **A Three-dimensional Space:** The user perceives an illusory three-dimensional “space” defined by the (computer graphic) objects within it and known as the *Virtual Environment* (VE). This illusion is composed of information rendered into a form the user can perceive—usually through computer graphics artwork.

- **Interaction:** The user must be able to interact with the virtual environment in a meaningful way (Zeltzer, 1992). Virtual objects and actors respond to the user in a manner consistent with their purpose and the overall theme of the environment. For example, a virtual cat in an Egyptian temple might come near the user, but avoid being “touched.”
- **Autonomy:** Many objects or processes in the virtual environment will (appear to) continue to operate without input from the user (Zeltzer, 1992). For example, a virtual dog digging holes in a virtual garden would continue to produce more holes, whether or not the user was nearby.
- **(Thematic) Presence:** The user must have some imaginary location *and* identity within the virtual environment. An actual virtual body and a co-located viewpoint may be clearly represented or merely implied. The important thing is that the user has a location in the virtual space and a role in the narrative.

For practitioners in the education and virtual heritage communities, these criteria are enough for an application to be considered Virtual Reality. We will call them examples of *Desktop VR*, because they nearly always use a standard computer monitor and keyboard and mouse. However, traditional VR researchers and computer scientists have a further requirement:

- **(Sensory) Presence:** The interface informs the senses so that the user sensorially feels like s/he is at a particular location in the virtual environment (Zeltzer, 1992). Perspective correction and other aspects of a visual display define the user’s *egocenter*, which is the user’s location in the virtual environment (Psotka, 1996). At a bare minimum, the display must produce a very wide view for the user, as with a digital partial-dome theater (e.g. a Planetarium) or a *Head Mounted Display* (HMD). See section 2.3, p17, for examples.

In the following discussion, we will call applications satisfying all five criteria, *Immersive Virtual Reality* (Immersive VR) and those which satisfy only the first four criteria, *Desktop Virtual Reality* (Desktop VR). We retain *Virtual Reality* (VR) as a general term referring to both.

### **7.1.2 VR Is Expressive**

Virtual Reality provides the educator with new ways to represent objects and systems more effectively than with other media. In VR, the user can interact with simulations of things that could be perceived in the real world (Roussos, 1999), because they are too small, too big, no longer exist, do not exist yet, dangerous, far away, or simply inconvenient. Students can make mistakes in a virtual environment safely and cheaply, which allows for learning activities not possible in the real world. A virtual environment could simulate dynamic systems such as ocean currents planetary motions, changes in electrostatic fields, or social behavior in a troop of gorillas. These simulations become especially powerful teaching tools when the student can participate in them, giving the student an inside view (egocentric) and the ability to experiment with the system (Winn, 1999; Bowman, 1999; Dede, 1999)

VR is also a powerful means of communication. Students and educators can collaborate over great distances using a networked virtual environment as a collaborative space (Cobb, 2002; Dede, 2004; Bruckman, 2002a; Andrews, 2002; R ih a, 1997; Raalte, 2003; Santos, 2002). The multisensory interface and potential methods of interaction allow VR applications to communicate a lot of information to and from the user (Bowman, 2002; Mayer 2001c). VR creates significant opportunities for non-written and even non-verbal communication, which can be very useful for certain situations and students. Autonomous agents can represent people conducting their business or interacting with the user (Ulicny, 2002). Pedagogical agents in the environment can guide and facilitate learning (Economou, 2001).

Nevertheless, virtual reality is still just one more form of media with comparative advantages and appropriate uses. VR should not be used as a general replacement for anything, but instead as part of a larger curriculum (Bowman, 1999; Wickens, 1992; Hay, 2000).

### **7.1.3 VR Can Accommodate the Learner**

The theoretical underpinnings of almost all educational experiments in Immersive VR, as stated by the authors, center on the idea of learning as active, self-directed, and context-dependent. The student does or makes something, alone or in a group to gain new knowledge. The student must *construct* new personal knowledge by understanding the lesson in terms of his or her prior

knowledge (Bloom, 1956) and perception of the world (Winn, 2003b). The instructor helps the students learn how to learn, facilitating and focusing the students' own process of exploration.

This model of learning is called *Constructivism* (Jonassen, 2000c). In *Activity Theory*, this is called the “co-construction of shared knowledge” (Vygotsky, 1978; Jonassen, 2000b; Jackson 2000). Hay (2000) calls it “investigation-based learning.” Many of the Immersive VR learning studies specifically claim a *Constructivist* basis (Fallman, 1999; Dalgarno, 2001b, 2002a, 2002b). The basic idea is that VR gives the instructor many ways to produce (and control) instructional situations for the students to work through. These special-purpose virtual environments can be rich in meaning and complexity or elegant and focused, as needed.

A very important part of this process is *Conceptual Change* (Gagne, 1987). This is the moment when students must abandon some misconception when confronted with both counter-evidence and a better explanation of what they thought they knew. Many Immersive VR learning studies were designed to produce this effect (Dede, 1999; Moher, 1999; Winn, 2001; Windshitl, 2000; Jackson, 2000; Johnson, 1999a). Conceptual Change is especially helpful in teaching science topics, where students often have misconceptions of natural processes.

Other researchers sought to more clearly define the learning process, adding approaches from *Cognitive Theory* (Winn, 2003a; Moreno, 2002b; Mayer, 2000b). We prefer Winn's (2003a) conditions for optimal learning with VR. The student must be **embedded** in the virtual world, meaning that learning tasks and overall experience are defined in whole or in part by the virtual reality application. The student must also be **embodied**, in that the learner's physical body is an essential part of the process. This could be as simple as requiring the student to perform physical actions, or as subtle as engaging the student's senses in a particular way. Finally, the student must engage in **dynamic adaptation**, always adjusting to changing circumstances. The individual and his or her environment evolve together, responding to each other. We use a fourth aspect, **Connectedness**, where the learner is connected to information, virtual entities or processes, other students, instructors, or other users. In our own research, we strive to develop learning experiences which have these properties to the extent possible.

We restate that researchers in educational Virtual Reality believe learning is an active and individual process, which good curriculum supports. Virtual Reality can support complex and meaningful interaction using metaphors which are naturalistic and easy to understand. The

virtual environment can respond to a student based on where that student is in the learning process.

#### 7.1.4 Sensory Presence Is Not Enough

We believe that sensory presence is one of many desirable forms of engagement. For example, an interesting conversation with an artificially intelligent character (an *agent*) may fascinate the student (Charles, 2007). Perhaps the student is very interested in the topic or intent on winning a VR-based learning game. Having a central place in the narrative (thematic presence) is certainly engaging. We believe that different types of engagement are mutually reinforcing and tend to have common causes, such as good application design.

Almost everyone involved in Educational Virtual Reality believes that sensory presence enhances student engagement and therefore facilitates learning. Nearly every article on the subject clearly states or strongly implies this, e.g., Furness (1997). Surveying the literature, we see that a sense of *presence* self-reported by the students is definitely correlated with learning in VR. However, correlation does not imply causation.

No experiment which relied solely on sensory presence to enhance learning was successful in showing any advantage for immersion (Moreno, 2002b; Byrne, 1996; Rose, 1996; Salzman, 1999). In these studies, sensory immersion was *not* relevant to the learning activities—their students could have done those activities equally well with a non-immersive display. In each experiment, there was no significant difference in learning between students who had an immersive display and those who did not. By contrast, all of the studies which did not show an advantage for immersion (Dede, 1999; Salzman, 1998; Winn, 2001) had the student perform learning tasks which depended on that student “being” in a particular location within the virtual environment. This allowed the student to perceive information and interact with the environment in a particular way.

We conclude that the value of an immersive display is *not* determined by the sensory presence it elicits, but by its functional support for the learning activity.



### 7.1.5 Immersion Must Support the Learning Activity

We are interested in when and how *Immersive* Virtual Reality can be helpful for learning. To be effective, an Immersive VR learning application must (1) be reliable, stable and useful, (2) support clearly defined learning activities, (3) employ some of the capabilities of VR, and (4) use the visual immersion to functionally support learning activities. The first two criteria are basic to any learning software. The third criterion is that the learning activities require some of the capabilities of VR to support a learning experience which other media could not do as well. Generally, one would ask this of any proposal to use a particular interactive medium for a particular learning activity. Similarly, one must use sensory immersion (Immersive VR) only if it is an integral part of a desirable learning activity which is not otherwise available.

Generally speaking, immersive virtual reality is appropriate when learning activity requires interaction between the student and something that is difficult or impossible to simulate or encounter in real life. Immersive VR will be more advantageous the more complex, context-dependent, and physical the task is. This is why pilots start learning to fly with flight simulators, historically, the first examples of Immersive VR technology.

Learning to operate a plane is usually described as *training*, while *education* is usually thought of as classroom learning. The distinction is vague, and we mention it only because there is much literature on using virtual reality for training in a variety of fields. The value of immersive virtual reality for training is not in doubt. We are interested in seeing how effective it can be as a tool for the major subjects taught in schools.

Salzman (1998), Dede (1999), and Winn (1997, 2001) have had success with topics in science, where the student works with an interactive representation of some otherwise invisible process. Many lessons in science are cognitively difficult to absorb, but lend themselves to helpful representations in virtual reality. We believe this is a fruitful area of research and look forward to further developments.

### **7.1.6 Virtual Heritage**

Virtual heritage (VH) is the use of electronic media to recreate or interpret culture and cultural artifacts as they are today or as they might have been in the past (Moltenbrey 2001; Roehl, 1997). We believe this is an excellent topic for VR learning research, given the centrality of visual artifacts and places, and the importance of history in real life and the classroom.

By definition, VH applications employ a three-dimensional representation of something and the means used to display it, from still photos to immersive virtual reality. This is a very active area of research and development, (Michell, 2000; Champion, 2004b; Champion, 2004c; Addison, 2000; Roehl, 1997; Stone, 2002; Levy, 2004) and most of it is intended for educational use. The majority of VH applications are architectural reconstructions, centered on reconstructed buildings or monuments, and most of them use VRML technology. A handful of VH applications illustrate topics on ancient Egypt (Kufu, 2004; Economou, 2001; Lehner, 2003; Michell, 2000; TutTomb, 2001).

These three-dimensional objects are “well-integrated” in the sense that much cultural information is encoded in the way the space looks to an observer. Therefore, applications in virtual heritage have much to gain by using virtual reality. While most VH applications are limited to the desktop (Kameas, 2000), some employ Immersive VR (iGrid, 2000; Pape, 2000; Park, 2003; PublicVR, 2008) some make excellent use of augmented reality (Papagiannakis, 2004a, 2004b). In our study, students interact with the Virtual Egyptian Temple (Jacobson, 2005e) using Immersive VR.

### **7.1.7 Learning Games**

The game paradigm is an excellent way to center interaction on the user in a flexible virtual environment. Educational researchers have been interested in harnessing games as a vehicle for learning for a long time (Avedon, 1972), and today such efforts have attracted significant interest and resources (Squire 2003, 2007; Kirriemuir 2004). Goal-seeking activities are especially effective and can be cast in the form of a game (Champion 2004b; DeLeon, 2000). Every game

is based on a microworld of some type, and IVR interfaces are optimal for interacting with many useful types of virtual environments, especially those with a high level of visual fidelity.

Today, computer games are a central activity in popular culture, with millions of children now playing them. Through video games and other electronic media, many students have developed a high degree of video literacy, comfort and competence with fast, information-dense input. Also, the game industry has developed a large quantity of powerful, flexible software that can be adapted for educational use, and much of it has already been adapted to IVR (Squire 2002, Kirriemuir 2004, and Jacobson 2005i). These new developments put many types of educational virtual reality within reach of educators and their institutions (Lewis, 2002). The key advantages of a game-based learning are:

1. The student's intense investment toward reaching a goal defined by the educator or designer.
2. Continual feedback for the student while interacting with the system.
3. A high degree of student involvement or investment in the activity itself.
4. The potential for intense student concentration on the learning task.

We believe that educational games are a special case of adaptive media and are well-suited to Constructivist learning activities *and* to Virtual Reality (Brusilovsky, 2003c).

**The key is to make the goals of the game serve the student's learning goals and the broader curriculum.** The student benefits little if the game is designed as some kind of a wrapper around the information he or she is expected to learn, because the student might play the game for its own sake and quickly forget the topic matter. For example, it would be easy to design a game in which the student gains points for solving riddles or remembering facts. However, it would be much more effective if the goal of the game was to accomplish something within the context of the topic matter. Winn (2001) provides an excellent example of good conceptual design. In his study, students adjust environmental factors in a simulated part of the world to find an optimal solution to global warming. The activity is definitely a game, although Winn does not describe it as such in his paper or to his subjects. The student simply enjoyed and learned. In our study, we structured the student learning experience as a game.

## 7.2 EXPERIMENT

### 7.2.1 Rationale

The goal of our study was to determine whether a visually immersive display can have a provable advantage over a non-immersive display for topics in cultural heritage.

We chose the Egyptian temple as the sample topic for our learning study, because the temple was absolutely central to Egyptian life and culture, *and* because it is appropriate for the virtual reality medium. The temple itself, the hieroglyphics, the painted images, and the conduct of ceremonies are all tightly integrated. The physical space itself is the main semantic organizing principle. Visual Immersion provides an **egocentric view**, which allows the observer to view the temple from the inside, as it was meant to be viewed in real life. To our knowledge, ours is the first formal experimental study in the use of immersive virtual reality for virtual heritage.

We chose the game metaphor for the advantages described in section 2.4.6, p38. With the temple, we saw a design opportunity in the information structure of the temple and supporting materials. We were able to structure the learning goals and activities in a way that is inextricable from the topic matter itself. See 3.3, p98, for details. To our knowledge, only Winn (2001) structured an Immersive VR learning experiment as a game in a formal learning experiment with. Our study would be the second.

The most difficult and important goal of our study was to demonstrate how an immersive display could have more utility than a cheaper desktop monitor in a realistic situation. Several previous studies failed to do this (Moreno, 2002b; Byrne, 1996; Rose, 1996; Salzman, 1999) and only one succeeded (Salzman, 1998). Guided by Salzman's experiment, we structured our experiment in terms of the effectiveness of an egocentric view versus an exocentric view, instead of their appropriateness for this particular topic matter. We also thought it important to test for the difference between short-term and long-term retention, and the interaction between students' level of visual skill and the display type.

## 7.2.2 Gates of Horus

In our study, eighty-five middle-school students (grades 6-8) learned about ancient Egyptian art, religion, and society by playing an educational learning game, *Gates of Horus*. The game is based on a Virtual Egyptian Temple (Jacobson, 2005e, 2004a), which has no real-world analog. Instead, it embodies only the key features of the typical New Kingdom period Egyptian temple in a way that an untrained audience can handle. The temple has four major areas, and each one has a copy of the High Priest, a pedagogical agent.

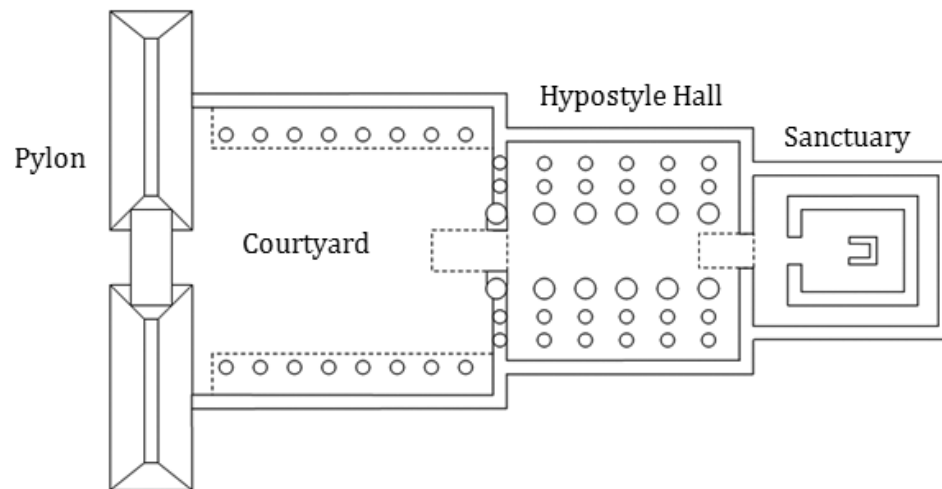

**Figure 47.** Map of the Virtual Egyptian Temple

Ordinarily, the student navigates the temple in Desktop VR (standard desktop PC) and selects spotlighted features of the Temple. Each time the student selects a feature, the priest will explain what it is and what it does. When the student clicks on the priest, the priest asks the student a question about one of the features the student selected earlier. When the student correctly answers all of the questions for a particular area, the gateway to the next area opens. The goal of the game is to reach the innermost area, the Sanctuary which contains the divine image of the God, Horus. When the student answers all the priest's questions for the Sanctuary, the divine image will speak and bring the blessings of heaven to the land of Egypt.

The software for *Gates of Horus* is based on a commercial game, UT2004 (EpicGames, 2008), and two freeware packages, CaveUT and VRGL (PublicVR, 2008). The freeware enables the game to operate in a variety of immersive displays. In our study, some students saw the temple on a standard desktop monitor while others used the Earth Theater at the Carnegie

Museum of Natural History in Pittsburgh (Figure 48). Otherwise, all students interacted with the game in the same way, one at a time and with a *Gyromouse*. In our study, students navigate through the temple and select items using the *Gyromouse*, a cordless hand-held device used in some VR applications (Duncan, 2006; Herpers, 2005; Olwal, 2002; Patel, 2001; Hafner, 2000; Winograd, 2000).



**Figure 48.** The Temple in the Earth Theater

### 7.2.3 Hypotheses

We randomly assigned each student to one of three groups. Each student in the *Theater Group* played *Gates of Horus* using the immersive dome display. Each student in the *Desktop Group* played the game on a standard desktop computer in an area adjoining the main theater. Members of the *Control Group* also played the game on a standard desktop but took the Post Test for basic knowledge *before* playing the learning game. The Control Group's scores on the Post Test take the place of a knowledge pretest for the other two groups. This is necessary, because any question-and-answer pretest given to the Theater and Desktop Groups would reveal too much information about the temple itself.

Our first *a priori* experimental hypothesis is that **(H0)** students will enjoy playing *Gates of Horus* and engage with it fully during the experiment. The second is that **(H1)** students who play *Gates of Horus* will learn something. A positive result in both hypotheses would show that we made an effective learning tool that students will actually use. Both are prerequisite for our core hypotheses, **(H2)**. students who play the game with Immersive VR will learn more and retain more than those who play it using Desktop VR, as measured immediately after testing and **(H3)** one or two months later. We specifically designed the experiment to test these hypotheses.

However, we added three other measures to test hypotheses which were not primary, but worth investigating. They are **(H4)** Students who played the game with ImmersiveVR will have better spatial knowledge of the temple than those who used Desktop VR, **(H5)** One or two months after playing *Gates of Horus*, students using ImmersiveVR will report more motivation to learn about Egypt, and **(H6)** students with low visual reasoning ability will benefit more from visual immersion *or* the opposite will be true (Bricken 1990). Regardless, we expect visual reasoning ability to matter.

#### **7.2.4 Protocol**

Upon arrival, each student was randomly assigned to an experimental group, Control, Desktop, or Theater. The following sequence describes the important tasks each student performed during the study.

- 1.** All students completed Raven's Progressive Matrices test, which measures current visual reasoning ability (Raven, 1957; Shiply, 1949; Gregory, 1999).
- 2.** Each student in the Desktop Group played Gates of Horus on a desktop computer.
- 3.** Each student in the Theater Group played Gates of Horus in the Earth Theater.
- 4.** Each student in the Control Group took the Post Test before playing Gates of Horus.
- 5.** Post Test questions are standard multiple-choice or short-answer.
- 6.** Gates of Horus records everything during play.
- 7.** Each student in the Desktop or Theater Group took the Post Test.
- 8.** Each student in the Control Group played Gates of Horus on a desktop computer.
- 9.** Each student drew a map of the temple to test his or her knowledge of its layout (Drawn Map Test).
- 10.** Each student placed magnets representing features of the temple onto a provided map of the Temple (Magnet Map Test).
- 11.** Each student produced a video tour of the virtual temple. The student stood in front of a projection of the virtual Egyptian temple, and navigated using the Gyromouse. The student conducted a show-and-tell tour of the virtual temple, which we recorded as a simple documentary video.
- 12.** One or two months later, the student completed the Follow-Up test via the Internet using any computer with a Web browser. This test is also a standard quiz, with multiple-choice and short-answer questions.



## 7.3 RESULTS

### 7.3.1 Acceptance

In the **Post Test**, students in the Theater and Desktop Groups answered a first set of questions about their **opinions and feelings** toward the learning game. (Students in the Control Group skipped these, because they had not yet played the game.) Results were strongly positive for all questions. Figure 49, below, illustrates results for the two most important.

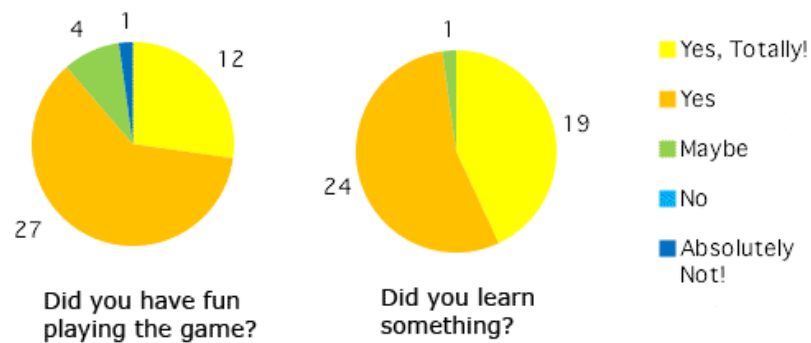

**Figure 49.** Key Affective Results

In addition to giving these strong self reports, nearly all students played the game from beginning to end, 45 minutes to one hour, without even asking for a break. Together, these factors indicate the students were fully engaged with the learning task (Gates of Horus) during our study, which satisfies **H0**. Because we did not ask the students to compare the game with anything else, this is not a *statistical* proof. It would be interesting to compare Gates of Horus to other learning games and other methods of instruction, but that is beyond the scope of this study.

### 7.3.2 Effectiveness

The remaining bulk of the **Post Test** quizzed students on their knowledge of the temple. We gave the test to the Control Group *before* they played the game to determine how well students could guess their way using prior knowledge and employing test-taking techniques. All other students played Gates of Horus first, and we compared their Post Test results with those of the Control Group.

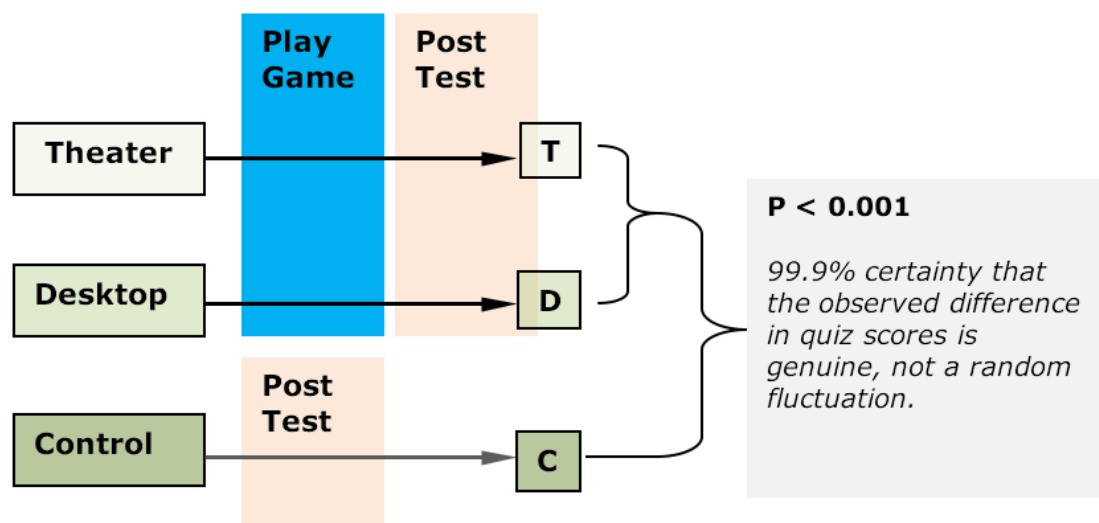

Figure 50. Post Test Sequence and Results.

Figure 50 shows the portion of our testing sequence which pertains to the Post Test. Each student earned a total score awarded by four graders (section 4.4, p144). The Post Test scores produced by students who played the game showed a high probability of being different from the scores of those who did not ( $P < 0.001$ ) when analyzed with the Mann-Whitney statistical test. Furthermore, students who played the game did (statistically) significantly better ( $P < 0.05$ ) in 22 out of the 45 relevant items on the Post Test. This is strong evidence that Gates of Horus is an effective learning tool, which satisfies **H1**. It allows us to meaningfully make further comparisons on the effectiveness of different versions of the game.

Next, we compared Post Test scores for the Theater Group versus Post Test scores for the Desktop Group (**H2**). The Theater group seemed to do better, but the difference was not

statistically significant. We believe that a quiz of this type is not sufficiently sensitive to measure the conceptual learning advantage that we expect from visual immersion.

### 7.3.3 Immersion

Each student produced a documentary video. First, three human graders evaluated the video for factual knowledge, and their judgments were combined to produce a final score. Our most important result was a significant difference between the *Video Test* results from the Theater Group with results for the other two groups combined. Figure 51 shows the stages of our testing sequence relevant to the Video Test and its main results. We included the Video Test scores from the Control Group, after they had played the game, because we did not think that the order of the Post Test and the game would make a substantial difference in their overall learning.

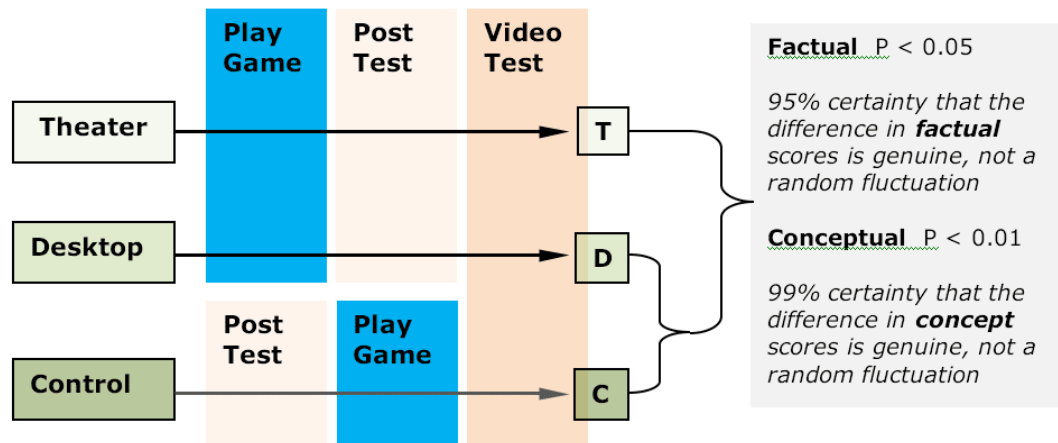

**Figure 51.** Video Test Sequence and Results.

Statistically, students in the Theater Group did significantly better than students in the other two groups (Mann-Whitney test,  $P < 0.05$ ). Looking at the individual facts that the students were expected to master, the Theater Group did significantly better in 9 out of 45 at the  $P < 0.05$  level and we found that 14 out of 45 at the  $P < 0.10$  level. Taken together, these results support **H2**.

Next, our Egyptologist, Dr. Lynn Holden, evaluated each student's video for the student's mastery of conceptual knowledge about the temple. Here, the difference was statistically much stronger, and a respectable number of individual measures also showed results significantly different (in 6 of 19,  $P < 0.05$ ). Dr. Holden also assigned an overall impression of the student's mastery of the information, which provided the strongest difference of all,  $P < 0.001$ . Not only were the main results for the conceptual and factual measures in accord, but they also tended to parallel each other in the individual measures. For every concept where the Theater Group statistically did better than the others, there was at least one fact related to that concept where the Theater Group *also* did better. We are confident that this data satisfies **H2**.

#### 7.3.4 Other Measures

We also compared results for the Follow-Up Test, one or two months later, and comparing responses from students in the Theater Group to all the others. Unfortunately, we saw no statistically significant differences, and there were not enough differences in individual scores to be convincing. The Follow-Up Test was very similar to the Post Test, except that students gave much less informative answers on the short-answer questions. We conclude that if there are any lasting comparative benefits to visual immersion over a standard desktop monitor, a standard quiz such as a Follow-Up Test is not sensitive enough to detect it. This leaves **H3** unproven.

In data from both the Drawn Map Test for **H4** and the Magnet Map Test for **H5**, we saw no significant differences in performance for the Theater Group versus the other groups, not even a trend in one direction or the other. This is at odds with the virtual reality training literature, which has established that Immersive VR is a good way to teach survey and route knowledge of an area. We conclude that the temple was too small and too simple for immersion to produce a genuine difference in students' knowledge which could be detected with a mapping test.

#### 7.3.5 Visual Reasoning Skill

We did see an interesting interaction between students' visual reasoning ability and their overall rating in the conceptual video data. As expected, we found that students with higher RPM scores

did significantly better, overall, than students with low RPM scores ( $P < 0.05$ ). More interestingly, students with low RPM scores seemed to benefit more from visual immersion than those with higher RPM scores. Table 35 summarizes our findings.

**Table 35.** Summary of RPM Effect

	Immersion (Theater Group)	Non-Immersion (Desktop Group & Control Group)	Mann-Whitney test
Low RPM Score	23 students' scores for the Video Test	23 students' scores for the Video Test	$P = 0.01$
High RPM Score	24 student's scores for the Video Test	24 students' scores for the Video Test	$P = 0.09$
High RPM vs. Low RPM	All students in both conditions		$P = 0.05$

As we describe earlier, our Egyptologist evaluated students' video tests for conceptual knowledge. Among other measures, he assigned each one an overall rating for mastery of the material. This is the conceptual score referred to in Figure 51. **Video Test Sequence and Results.**, p253. Using the Mann-Whitney test, we saw that scores for Low-RPM students in the Theater Group were significantly different from the scores of those in the other groups. Differences at the 0.01 level are considered quite strong. There was also a difference for High-RPM students, at the  $P = 0.09$  level, which is considerably weaker. Although it is far from conclusive, we consider this evidence to support **H6**.

Our evidence for **H6** implies that students with lower (current) visual reasoning ability benefit more from visual immersion than their more visually skilled classmates. One other study showed an interaction between visual reasoning and learning with virtual reality. In Winn (1997), students with low RPM scores benefited more (than students with high RPM scores) from producing small virtual environments than from experiencing them. Our results and his imply that further research comparing visual reasoning skill/ability and learning results in Immersive VR may be fruitful.

## 7.4 DISCUSSION

Our study directly demonstrates that a visually immersive display is more effective than a standard computer monitor for a reasonable learning activity in an important topic area (**H2**). The immediate implication is that Immersive Virtual Reality is the optimal interface for learning declarative and conceptual knowledge, if:

1. Some visual artifact effect or process provides the central organizing theme for the material.
2. The immersive interface allows the student to interact with the information in some way not otherwise available or efficient.
3. Almost every way in which the student interacts with the virtual environment is relevant to the learning task.

In our study, a very wide egocentric view of the Virtual Egyptian Temple allowed students to (1) navigate less and think more and (2) see the interior of the temple as a whole, rather than as a collection of features. Generally, if the objective is for the student to understand some artifact system or phenomenon as a whole, have the student work with it as a whole.

In some topics, Immersive VR is the best medium for this. Salzman (1998) produced the only other study to clearly demonstrate an educational advantage of adding Immersive VR's capabilities to what a non-immersive display can provide. Her experiment centered on understanding magnetic fields and science topics which can be presented in a similar way. By achieving a similar result in the area of cultural heritage, we have identified another large intellectual territory where Immersive VR has practical use. We hope that future studies will provide more such working examples to add to the existing literature. For example, someone could conduct an experiment in which students learn to "read" an urban neighborhood to determine its planning needs.

Our data showed that the immersed students learned better than those with only a monitor, but it did not tell us *why*. Perhaps the immersed students (a) had a mechanical advantage to access information encoded in the environment, (b) developed a deeper understanding of the topic materials, because the immersive view presents the information in a more coherent manner (c) experienced a deeper sense of presence in the virtual environment or (d) benefited from some mixture of all three factors. We can safely discount *presence* as a

significant factor because self-reported presence was only slightly different between students who used Immersive VR and those who use desktop VR. Furthermore, previous studies which isolated presence in ImmersiveVR as a potential influence on learning showed no effect (Moreno, 2002b; Byrne, 1996; Rose, 1996; Salzman, 1999). Separating the other two factors would not be so simple.

We could certainly restructure the study to isolate the benefits of the Immersive view from the benefits of the physical interaction. That would require a difficult and interesting set of experiments concerned with understanding how the computer and the human work together. Alternatively, we could try a “brute force” approach, where we repeat the experiment with better evaluation tools, a larger sample size, a longer exposure time (perhaps as part of a larger curriculum) and a larger and more meaningful lesson. If successful, this would further verify our results and allow us to make fine-grained comparisons of factors such as the effect of RPM score, gender, or video game experience.

We are particularly interested in our data which *implies* that students with lower visual reasoning skills (as measured by RPM score) benefited more from visual immersion in our experiment (**H6**). It would be fairly straightforward to conduct follow up experiments to see if this is really happening. If the finding is corroborated, perhaps Immersive VR could be used to improve visual reasoning skills among the students who need it most. In the meantime, it could help them keep up with their more skilled peers in certain topics.

We could deepen the study by adding more interaction possibilities for the student. We are particularly interested in adding people to the Virtual Egyptian Temple (or some other space) to provide a social context. These people could be a mixture of automatons, educators, and other students, re-creating aspects of the ancient society. As a teaching tool, adding virtual people should be very effective, and for the archeologist it would be a means of testing hypotheses on what ancient cultures were like.

We are pleased to see that the students liked the game, Gates of Horus, which was our central learning activity for all conditions and experiment (**H0**). The fact that students did learn from the game, regardless of interface, is also important and useful (**H1**). Without these results, data comparing learning with or without immersion (**H3**) would have been meaningless.

Our ultimate goal is to inform the educator on when and how to employ Immersive Virtual Reality. We see it as a new learning tool which the educator and student can combine

with existing approaches to solve real problems for real people. With that in mind, we look at these trends:

1. Educational research applications and practice using Desktop VR have exploded in recent years, with the bulk of the growth in shared online communities. Students' comfort with technology and continuing advances in personal electronics and telecommunications make Desktop VR increasingly practical.
2. The sophistication of projection hardware is increasing as its cost is decreasing, which has made visually immersive displays affordable for schools, museums and small institutions. A very important part of this trend is the fact that planetaria and dome displays are increasingly all-digital. Eventually, personal visual immersive displays will become affordable for individuals in schools.
3. The gaming metaphor is becoming increasingly influential in education, as educators exploit the opportunities it affords. Students' high acceptance and intense concentration on current video games is irresistible to educators. It will become more important, as new teachers who played video games as children grow up to be teachers.
4. A wide range of industries and academic disciplines are increasingly adopting computer graphics of all types. Within almost every professional literature, one can find a small but persistent subset concerned with the use of virtual reality to address their topic.
5. Museums, especially science museums, continue to innovate with interactive displays of all types. Unlike the schools, they must make their exhibits and educational programs interesting to continue to attract patrons.

We believe these trends are converging toward a wider use of interactive immersive media, especially in museum education and educational gaming. We believe that our study was well-positioned to explore questions relevant to this near future, and we look forward to building on the results.



## APPENDIX A

### [ONLINE QUESTIONNAIRES]

In this appendix we will show examples of *all* the online questionnaires used in this study. We present them *exactly as they appeared to the test subjects (students) and the graders*. We show the Pretest, Presence and Comfort Test, Post Test and Follow Up Test questionnaires in their entirety. All of the grading forms are individualized, one for each student for each type. For example, there is an individual Post Test Grading Form for *every* student in the study. We show one example for each grading form.

# PRETEST

Pretest

[Exit this survey >>](#)

## 1. Gates of Horus Pretest

You may begin as soon as you are ready.

\* 1. What is your code name?

\* 2. How old are you?

- 11
- 12
- 13
- 14

\* 3. What grade are you in, at school?

- 6th
- 7th
- 8th

\* 4. Are you a boy or a girl?

- boy
- girl

\* 5. How many hours a day do you use a computer?

- none
- 0-1
- 1-3
- 3-6
- 7 or more

\* 6. Do you play computer games?

- yes

no

\*7. On average, how many hours a day do you play computer games?

- none
- 0-1
- 1-2
- 2-3
- 4 or more

\*8. Do you play some computer games that have a three dimensional world?

- yes
- no

\*9. How do you feel about computers?

Very bad

Very good

Computers

\*10. How interested are you in Ancient Egypt?

Not Very

Very

Ancient Egypt

\*11. How many times have you visited an Egyptian collection in a museum?

- none
- one or two
- three to ten
- more than ten

\*12. Have you ever visited the Egypt Hall at Carnegie Museum of Natural History?

- yes
- no

\*13. How many books about Ancient Egypt have you looked at?

- none
- one or two
- three to five
- more than five

\* 14. When do you know you are experiencing Virtual Reality? Select all that apply:

- Using a computer
- Interacting with a three dimensional world
- Dreaming
- Seeing the computer animated world all in big wide view, sometimes all around you
- Playing a game

\* 15. Have you ever played a virtual reality game?

- yes
- no

\* 16. Did you ever play with a virtual reality game or ride at an amusement park or arcade?

- yes
- no

\* 17. Which of the following do you know something about?

- Ramses
- The Sphinx
- The Nile River
- The Valley of the Kings
- Scarab Beetles

Done >>

## PRESENCE AND COMFORT TEST

### Presence and Comfort Test

Student Code: \_\_\_\_\_

While you were playing the game, to what extend did you feel you were *inside* the Egyptian temple. Please pick a number answer, on a scale of zero to ten, based on the key below

- 0 = I did NOT feel like I was inside the temple, at all.
- 1-4 = Maybe I felt like I was in the temple, but only a little.
- 5-6 = I did kind of feel like I was in the temple.
- 7-9 = I had a strong feeling of being inside the temple.
- 10 = I felt like I was totally inside the virtual temple.

Your answer \_\_\_\_\_

For each questions, please select the answer that applies

Do <b>you</b> feel sick?	No	A little	A lot
Does your head hurt?	No	A little	A lot
Do your eyes hurt?	No	A little	A lot
Do you have an upset stomach?	No	A little	A lot
Are you dizzy with your eyes open?	No	A little	A lot
Are you dizzy with your eyes closed?	No	A little	A lot
Are you burping at all?	No	A little	A lot

# DRAWN MAP GRADING FORM

Spiderman Drawn Maps [Exit this survey >>](#)

## 1. Spiderman Drawn Maps

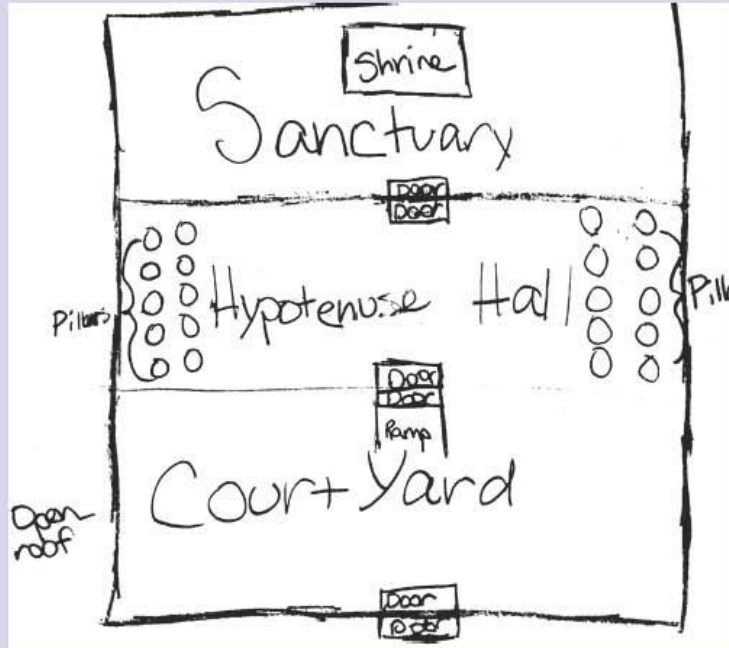

Please disregard labels. We are interested in how the students' maps **look**, only.

### 1. Grader Name

### 2. student code name

### 3. Basic questions.

yes

no

Did the student indicate that the temple is a building with an



inside and an outside?		
Did the students draw or indicate where the front of the temple is?	<input type="checkbox"/>	<input type="checkbox"/>
Did the student actually draw the pylon	<input type="checkbox"/>	<input type="checkbox"/>
Did the student draw a room that is recognizable as the courtyard?	<input type="checkbox"/>	<input type="checkbox"/>
Did the student draw room that is recognizable as the Hypostyle Hall?	<input type="checkbox"/>	<input type="checkbox"/>
Did the student draw room that is recognizable as the Sanctuary?	<input type="checkbox"/>	<input type="checkbox"/>
Did the student draw the shrine?	<input type="checkbox"/>	<input type="checkbox"/>
If the student drew the shrine, is it correctly placed?	<input type="checkbox"/>	<input type="checkbox"/>
Are the rooms of the temple connected?	<input type="checkbox"/>	<input type="checkbox"/>
Are the rooms of the temple correctly ordered?	<input type="checkbox"/>	<input type="checkbox"/>
Are the hawk statues indicated?	<input type="checkbox"/>	<input type="checkbox"/>
Did the student draw one or more priests?	<input type="checkbox"/>	<input type="checkbox"/>

Are at least some of the oil lamps indicated?



is the divine image of the god indicated?



**4. Looking at the student's map, rate how well the rooms are proportioned with respect to each other.**

- Exactly Correct
- Essentially Correct
- Mediocre
- Out of proportion
- Greatly out of proportion

**5. Describe the columns as the student drew them. Check all that apply. The student drew...**

	The Courtyard	The Hypostyle Hall	The Sanctuary
the correct number of columns	<input checked="" type="checkbox"/>	<input checked="" type="checkbox"/>	<input checked="" type="checkbox"/>
the correct number of rows of columns	<input checked="" type="checkbox"/>	<input checked="" type="checkbox"/>	<input checked="" type="checkbox"/>
some rows of columns are in the correct location	<input checked="" type="checkbox"/>	<input checked="" type="checkbox"/>	<input checked="" type="checkbox"/>
some rows of columns are in the wrong location	<input checked="" type="checkbox"/>	<input checked="" type="checkbox"/>	<input checked="" type="checkbox"/>
opposing ranks of columns are different in number	<input checked="" type="checkbox"/>	<input checked="" type="checkbox"/>	<input checked="" type="checkbox"/>

**6. Comparing the number of columns in the Hypostyle Hall versus the Courtyard.**





- The Hypostyle Hall is shown with more columns than the Courtyard.
- Both rooms are shown with the same number of columns.
- Both rooms have NO columns at all.
- the courtyard is shown with more columns than the Hypostyle Hall.

**7. How many features of the temple are correctly labeled?**

**8. How many features of the temple are correctly described in a general way? for example of students may use "statue" to describe the divine image of the god in the shrine.**

**9. how many features of the temple are MISlabeled?**

**10. Do you wish to say anything else anything else about this student's drawing of the temple?**

Done >>

# MAGNET MAP GRADING FORM

Dolores Magnet Maps	<a href="#">Exit this survey &gt;&gt;</a>
<b>1. Dolores Magnet Maps</b>	

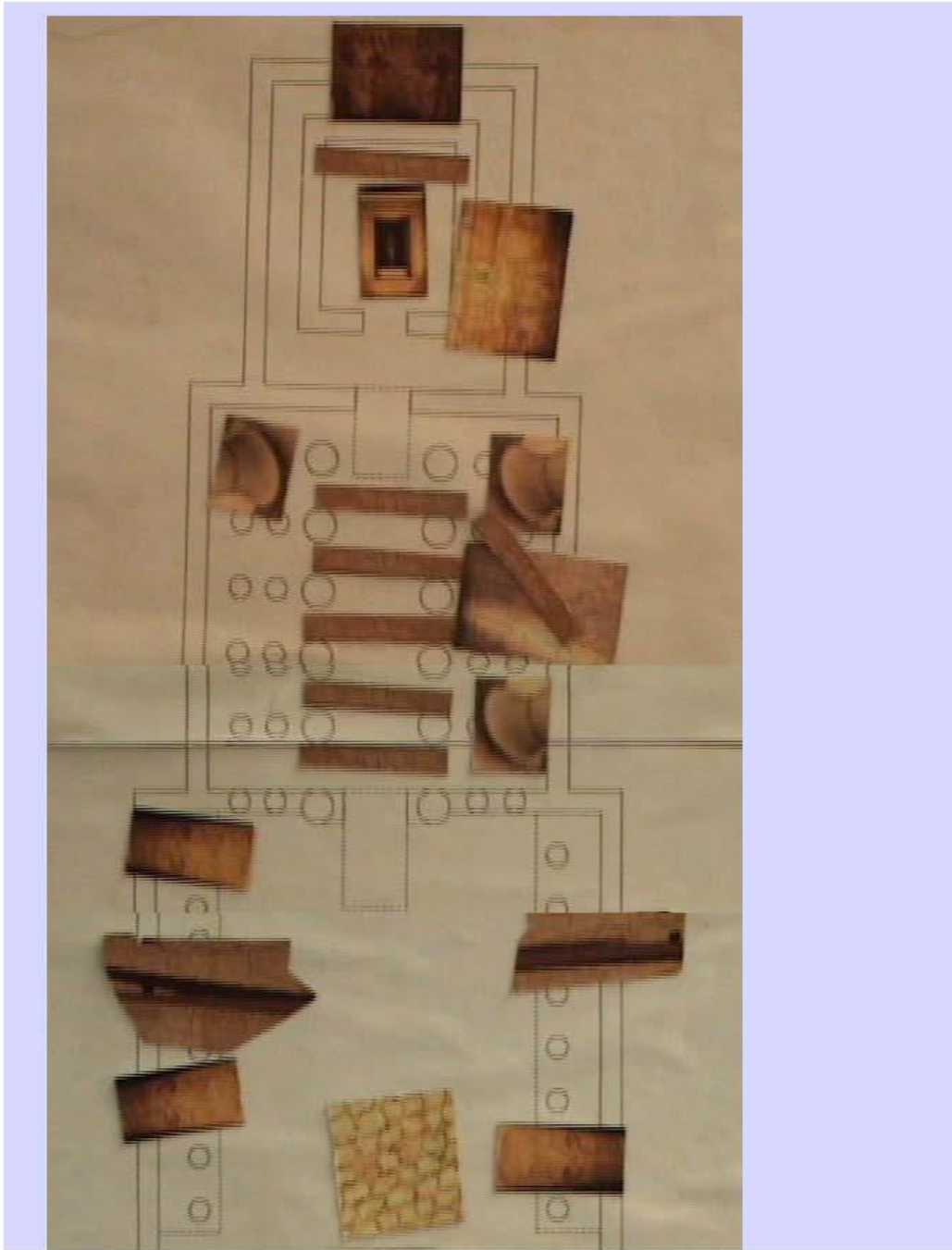

**1. grader name**

**2. student code name**

**3. Single Location Items**

	Correctly placed	On the correct wall or ceiling/floor	In the correct room	In the wrong room	not placed
shrine	<input type="radio"/>	<input type="radio"/>	<input type="radio"/>	<input type="radio"/>	<input type="radio"/>
ceiling hawks	<input type="radio"/>	<input type="radio"/>	<input type="radio"/>	<input type="radio"/>	<input type="radio"/>
purification scene	<input type="radio"/>	<input type="radio"/>	<input type="radio"/>	<input type="radio"/>	<input type="radio"/>
offering scene	<input type="radio"/>	<input type="radio"/>	<input type="radio"/>	<input type="radio"/>	<input type="radio"/>
HYPOSTYLE floor	<input type="radio"/>	<input type="radio"/>	<input type="radio"/>	<input type="radio"/>	<input type="radio"/>
courtyard floor	<input type="radio"/>	<input type="radio"/>	<input type="radio"/>	<input type="radio"/>	<input type="radio"/>
Khunm	<input type="radio"/>	<input type="radio"/>	<input type="radio"/>	<input type="radio"/>	<input type="radio"/>
Pharaoh Offers	<input type="radio"/>	<input type="radio"/>	<input type="radio"/>	<input type="radio"/>	<input type="radio"/>
boat scene	<input type="radio"/>	<input type="radio"/>	<input type="radio"/>	<input type="radio"/>	<input type="radio"/>

**4. multi location items**

	in one of the correct locations	in the wrong location	not placed
priest	<input type="radio"/>	<input type="radio"/>	<input type="radio"/>
archway	<input type="radio"/>	<input type="radio"/>	<input type="radio"/>
hawk one	<input type="radio"/>	<input type="radio"/>	<input type="radio"/>
hawk two	<input type="radio"/>	<input type="radio"/>	<input type="radio"/>
lamp one	<input type="radio"/>	<input type="radio"/>	<input type="radio"/>
lamp two	<input type="radio"/>	<input type="radio"/>	<input type="radio"/>
winged disk one	<input type="radio"/>	<input type="radio"/>	<input type="radio"/>
winged disk two	<input type="radio"/>	<input type="radio"/>	<input type="radio"/>
winged disk three	<input type="radio"/>	<input type="radio"/>	<input type="radio"/>
winged disk four	<input type="radio"/>	<input type="radio"/>	<input type="radio"/>

winged disk five

winged disk six

winged disk seven

**5. Location for Pharaoh Smites to the Right**

- correctly placed
- on the pylon where "smites to the left" should be
- elsewhere on the exterior
- in the courtyard
- in the HYPOSTYLE hall
- in the sanctuary
- not placed

**6. Location for Pharaoh Smites to the Left**

- correctly placed
- on the pylon where "smites to the right" should be
- elsewhere on the exterior
- in the courtyard
- in the HYPOSTYLE hall
- in the sanctuary
- not placed

**7. the flags**

- on the pylon, correctly placed
- on the pylon reversed
- elsewhere notes in or on the temple
- not placed

**8. Horus grants authority**

- correctly placed
- on the pylon where osiris should be

## VIDEOTEST GRADING FORM

Batman Video [Exit this survey >>](#)

### 1. Batman Video

This is a generic grading form for a student video. You will need to have the video handy on a TV/VCR or a MAC and be able to pause/backup/etc. easily. You will find that the quality of the students' presentations vary greatly, so some will be very quick to grade (little or no content) and others will take some time. Some of the videos have very poor sound quality, if you are unable to discern what the student is saying, skip the video and indicate it here.

**1. Grader Name**

**2. Is the sound quality is too poor to grade this video?**

yes

## 2. Pylon

**3. REMEMBERING FACTS:** Evaluate the extent to which the student repeats or paraphrase what the priest told him/her as well as facts which should be apparent from the appearance of certain features of the temple? Indicate for each fact.

	none	half	full
The temple is well ordered	<input type="radio"/>	<input type="radio"/>	<input type="radio"/>
the pylon is a symbol of what Egypt could be	<input type="radio"/>	<input type="radio"/>	<input type="radio"/>
the pylon is the most massive part of the temple.	<input type="radio"/>	<input type="radio"/>	<input type="radio"/>
the pylon was colorful.	<input type="radio"/>	<input type="radio"/>	<input type="radio"/>
the colors of the pylon had been worn away over time.	<input type="radio"/>	<input type="radio"/>	<input type="radio"/>
the pylon represents the mountains on either side of the Nile.	<input type="radio"/>	<input type="radio"/>	<input type="radio"/>
pharaoh is shown defeating the enemies of Egypt	<input type="radio"/>	<input type="radio"/>	<input type="radio"/>
the the god grants pharaoh his authority	<input type="radio"/>	<input type="radio"/>	<input type="radio"/>
a sword represents the authority that the god gives to pharaoh	<input type="radio"/>	<input type="radio"/>	<input type="radio"/>

This temple is dedicated to the god Horus	<input type="checkbox"/>	<input type="checkbox"/>	<input type="checkbox"/>
the hawk's statues represent Horus	<input type="checkbox"/>	<input type="checkbox"/>	<input type="checkbox"/>
horus protects pharaoh	<input type="checkbox"/>	<input type="checkbox"/>	<input type="checkbox"/>
the statue of pharaoh beneath the hawk's breast shows that the god protects him.	<input type="checkbox"/>	<input type="checkbox"/>	<input type="checkbox"/>
Horus represents all gods	<input type="checkbox"/>	<input type="checkbox"/>	<input type="checkbox"/>
pharaoh is the link between the people and the gods	<input type="checkbox"/>	<input type="checkbox"/>	<input type="checkbox"/>
pharaoh and the gods are united for the good of the world	<input type="checkbox"/>	<input type="checkbox"/>	<input type="checkbox"/>
horus is the god of Kingship	<input type="checkbox"/>	<input type="checkbox"/>	<input type="checkbox"/>
the hawk is the symbol of Horus	<input type="checkbox"/>	<input type="checkbox"/>	<input type="checkbox"/>
The winged disk is a symbol of unity and protection	<input type="checkbox"/>	<input type="checkbox"/>	<input type="checkbox"/>
the winged disk represents the divine life-force	<input type="checkbox"/>	<input type="checkbox"/>	<input type="checkbox"/>
the winged disk is a symbol of the world	<input type="checkbox"/>	<input type="checkbox"/>	<input type="checkbox"/>
the winged disk represents creation	<input type="checkbox"/>	<input type="checkbox"/>	<input type="checkbox"/>



the winged disk  
represents life

and a script  
represents protection

**4. GOAL CONCEPT(s):** The student is expected to infer these ideas from the facts.

none

half

high

The Egyptians  
thought that the  
world was orderly.

The Egyptians  
thought the world  
was centered on  
Egypt and it's  
gods.

**5. EXTRA:** Did the students make any TRUE statements about the pylon which do NOT appear in the previous two questions? Please list.

**6. MISTAKES:** How many incorrect or glaringly false statements did the student make?

one

two

three

four

five+

**7. COMMENTS:** please add anything you want to say about the students' performance in this area of the temple.

<< Prev

Next >>

## 3. Courtyard

**8. REMEMBERING FACTS:** Evaluate the extent to which the student repeats or paraphrase what the priest told him/her as well as facts which should be apparent from the appearance of certain features of the temple? Indicate for each fact.

	none	half	full
The courtyard holds several hundred.	<input type="radio"/>	<input type="radio"/>	<input type="radio"/>
Everybody could come there from, Farmer to Pharaoh	<input type="radio"/>	<input type="radio"/>	<input type="radio"/>
Open and undivided.	<input type="radio"/>	<input type="radio"/>	<input type="radio"/>
made for large religious celebrations.	<input type="radio"/>	<input type="radio"/>	<input type="radio"/>
The celebrations were joyous.	<input type="radio"/>	<input type="radio"/>	<input type="radio"/>
The joy of the celebrations showed people's gratitude to the gods.	<input type="radio"/>	<input type="radio"/>	<input type="radio"/>
everyone offered their best things at the celebrations.	<input type="radio"/>	<input type="radio"/>	<input type="radio"/>
Everyone came wearing simple garments to show their humility before the gods.	<input type="radio"/>	<input type="radio"/>	<input type="radio"/>
The open sky indicates the connection between	<input type="radio"/>	<input type="radio"/>	<input type="radio"/>

heaven and earth.			
The sun represents the creator god, Amon.	<input type="radio"/>	<input type="radio"/>	<input type="radio"/>
All Egypt was (supposed to be) united under the sun.	<input type="radio"/>	<input type="radio"/>	<input type="radio"/>
The offering scene mural shows pharaoh giving "every good thing" to the god	<input type="radio"/>	<input type="radio"/>	<input type="radio"/>
The offering scene mural Shows the god blessing the King and Egypt with life and prosperity.	<input type="radio"/>	<input type="radio"/>	<input type="radio"/>
On the pillar, the Pharaoh and Horus embrace.	<input type="radio"/>	<input type="radio"/>	<input type="radio"/>
On the pillar, Horus represents the gods and the natural world	<input type="radio"/>	<input type="radio"/>	<input type="radio"/>
On the pillar, Horus and Pharah embracing represents the gods and humanity coming together	<input type="radio"/>	<input type="radio"/>	<input type="radio"/>
<b>9. GOAL CONCEPT(s): The student is expected to infer these ideas from the facts.</b>			
	none	half	high
The people gave thanks to the gods as a	<input type="radio"/>	<input type="radio"/>	<input type="radio"/>

community.

**10. EXTRA:** Did the students make any TRUE statements about the pylon which do NOT appear in the previous two questions? Please list.

**11. MISTAKES:** How many incorrect or glaringly false statements did the student make?

one

two

three

four

five+

**12. COMMENTS:** please add anything you want to say about the students' performance in this area of the temple.

<< Prev

Next >>

## 4. Hypostyle Hall

**13. REMEMBERING FACTS:** Evaluate the extent to which the student repeats or paraphrase what the priest told him/her as well as facts which should be apparent from the appearance of certain features of the temple? Indicate for each fact.

	none	half	full
the hall is a quiet and private place	<input type="radio"/>	<input type="radio"/>	<input type="radio"/>
the hall is built on a grand scale to let you know it is sacred	<input type="radio"/>	<input type="radio"/>	<input type="radio"/>
only the literate class could come here	<input type="radio"/>	<input type="radio"/>	<input type="radio"/>
they honored their ancestors here	<input type="radio"/>	<input type="radio"/>	<input type="radio"/>
by honoring their ancestors they connected with heaven	<input type="radio"/>	<input type="radio"/>	<input type="radio"/>
They made offerings to their ancestors	<input type="radio"/>	<input type="radio"/>	<input type="radio"/>
the offerings were placed before statues of their ancestors	<input type="radio"/>	<input type="radio"/>	<input type="radio"/>
anyone could have an ancestor statue at work or at home	<input type="radio"/>	<input type="radio"/>	<input type="radio"/>
if you made a big donation to the temple you could have an ancestor statue tonight the hall.	<input type="radio"/>	<input type="radio"/>	<input type="radio"/>

the columns represent the primeval marsh.



the marsh surrounded the first mound of land



the first land rose from the waters at the beginning of time



The hawks on the ceiling are spirit guides



the hawks guide you deeper into the temple



the hawks show the connection between heaven and earth



**14. GOAL CONCEPT(s):** The student is expected to infer these ideas from the facts.

none

half

high

The Hypostyle Hall is an intimate space.



The Hypostyle Hall provides the worshiper a private connection to the divine.



**15. EXTRA:** Did the students make any TRUE statements about the pylon which do NOT appear in the previous two questions? Please list.

**16. MISTAKES:** How many incorrect or glaringly false statements did the student make?

one

two

three

four

five+

**17. COMMENTS:** please add anything you want to say about the students' performance in this area of the temple.

<< Prev

Next >>

## 5. Sanctuary

**18. REMEMBERING FACTS:** Evaluate the extent to which the student repeats or paraphrase what the priest told him/her as well as facts which should be apparent from the appearance of certain features of the temple? Indicate for each fact.

	none	half	full
the sanctuary is the most important part of the temple	<input type="radio"/>	<input type="radio"/>	<input type="radio"/>
the sanctuary has the best decorations	<input type="radio"/>	<input type="radio"/>	<input type="radio"/>
everything there is made of the best materials	<input type="radio"/>	<input type="radio"/>	<input type="radio"/>
the most important ceremonies happened there	<input type="radio"/>	<input type="radio"/>	<input type="radio"/>
the ground under the sanctuary was the very first part of the world.	<input type="radio"/>	<input type="radio"/>	<input type="radio"/>
Time began here.	<input type="radio"/>	<input type="radio"/>	<input type="radio"/>
Every Egyptian town from the world again under their particular temple.	<input type="radio"/>	<input type="radio"/>	<input type="radio"/>
The divine image of Horus stands in the shrine.	<input type="radio"/>	<input type="radio"/>	<input type="radio"/>
Horus represents all gods.	<input type="radio"/>	<input type="radio"/>	<input type="radio"/>
At times, the spirit of the God inhabits the divine	<input type="radio"/>	<input type="radio"/>	<input type="radio"/>



image.

If the god was pleased, he would make good things happen for the community, such as a good harvest.



The shrine was the gateway to heaven.



The blessings of heaven flow from the shrine, through the temple, and on to Egypt.



Pharaoh makes the blessings of heaven flow, by conducting the proper ceremonies correctly.



The high priest could act in pharaoh's place.



**19. GOAL CONCEPT(s):** The student is expected to infer these ideas from the facts.

none

half

high

pharaoh communicates with the gods



here, pharaoh brings down the blessings of heaven by honoring the gods



**20. EXTRA:** Did the students make any TRUE statements about the pylon which do

NOT appear in the previous two questions? Please list.

21. MISTAKES: How many incorrect or glaringly false statements did the student make?

one

two

three

four

five+

22. COMMENTS: please add anything you want to say about the students' performance in this area of the temple.

<< Prev

Next >>

**6. Final Notes**

**23. Is there anything else you want to say about the students' performance in their video? Did they seem to understand what they were talking about? Did they make interesting connections between facts? Did they display knowledge of this league learn from other sources besides the learning-game?**

[<< Prev](#)[Done >>](#)

**6. Final Notes**

**23. Is there anything else you want to say about the students' performance in their video? Did they seem to understand what they were talking about? Did they make interesting connections between facts? Did they display knowledge of this league learn from other sources besides the learning-game?**

<< Prev

Done >>

# POST TEST

Post Test [Exit this survey >>](#)

## 1. Post test

\* 1. What is your code name?

2. For each of the following questions, please check the box which best matches your answer.

	Absolutely not	no	maybe	yes	Yes, Totally!
Did you have fun playing the game?	<input type="radio"/>	<input type="radio"/>	<input type="radio"/>	<input type="radio"/>	<input type="radio"/>
Would you recommend Gates of Horus to your friends?	<input type="radio"/>	<input type="radio"/>	<input type="radio"/>	<input type="radio"/>	<input type="radio"/>
Did you learn something?	<input type="radio"/>	<input type="radio"/>	<input type="radio"/>	<input type="radio"/>	<input type="radio"/>
Are you glad you learned what you did learn?	<input type="radio"/>	<input type="radio"/>	<input type="radio"/>	<input type="radio"/>	<input type="radio"/>
Are you glad you played the game?	<input type="radio"/>	<input type="radio"/>	<input type="radio"/>	<input type="radio"/>	<input type="radio"/>
Would you like to play another game like it?	<input type="radio"/>	<input type="radio"/>	<input type="radio"/>	<input type="radio"/>	<input type="radio"/>
Do you want to learn more about ancient Egypt?	<input type="radio"/>	<input type="radio"/>	<input type="radio"/>	<input type="radio"/>	<input type="radio"/>

\* 3. What was the important symbol above all of the doorways in the temple?

- Son of the Sun
- Hawk God
- Winged Disk
- Double crown of Egypt

\* 4. The great, big, front of the temple was called the

- Horus
- Gate
- Pylon
- Mountains

\* 5. Like many of the real temple ruins in Egypt, most of our temple does not have much color. Why?

- Somebody in the 20th century spray-painted all the ruins with the sandy/gold color you see.
- It's supposed to be that way
- Over the centuries, the colors were worn away.

\* 6. What was the important symbol above all of the doorways in the temple? \_\_\_\_\_.

\* 7. Who or what gives Pharaoh the authority to defeat the enemies of Egypt, according to the ancient Egyptians?

- The people of Egypt
- The Gods
- The Egyptian Army
- The rich nobility

\* 8. When Pharaoh went before the gods with his offerings, who was he representing? Whose interests was he looking out for?

- Himself
- The Egyptian people
- the nobility

\* 9. Very important festivals took place in the Courtyard of the temple. Who went to these festivals?

- everybody
-

the workers and the lower classes

pharaoh and the priests

the nobility

\* 10. How could an Egyptian get a statue representing their ancestors placed permanently in the Hypostyle Hall of the Temple?

making a large donation to the temple

by sneaking it in

by being a noble or member of the upper classes

by wearing a very large silly hat

\* 11. Suppose you ask any ancient Egyptian "where did the world begin?" They will answer

where the great temple at Karnak is now built

I don't know

the very place where our temple is built, right in our town

\* 12. Did the roof of the Hypostyle Hall have square holes in the ceiling?

yes

no

\* 13. What happened in the Hypostyle Hall? (select all that apply)

Quiet Meditation

People honored the god Horus

People honored their ancestors

Eating and Drinking

\* 14. What did Pharaoh do in the Sanctuary? (check all that apply)

Rested

Fed the god

Represented the people of Egypt

Worshiped his ancestors

\* 15. The Shrine in the Sanctuary was (Select all that apply:)

- ✓ A magical gateway to heaven.
- ✓ The place where the sacred image (statue) of the god stood.
- ✓ The point from which the blessings of would flow outward to the land of Egypt.

Next >>



**2. moved**

**\*16. What does the Pylon tell us about how the Egyptians wanted the world to be like?**

**\*17. What did people do in the Courtyard?**

**\*18. What happened in the Hypostyle Hall?**

**\*19. What did Pharaoh do in the Sanctuary? How did the Sanctuary compare with the rest of the temple?**

**\*20. Tell us one thing you learned from playing with the temple.**

<< Prev

Done >>

# POST TEST GRADING FORM

KimKim (PostTest)
[Exit this survey >>](#)

**1. KimKim (PostTest)**

**1. Grader Name**

This grading form is individualized to the above named student. It asks you to evaluate their students' performance on those questions from the post test which we require human judgment.

In grader-questions 2-6, below, the original student-question appears in italics followed by the student's answer. Below that is a list of ideas or characteristics that the student answer may have or contain. Use the button bar to the right to give the student no credit, half credit or full credit for that aspect of their answer. Question seven and eight have a similar format, them but the grading choices are somewhat different. The last question provides a space for your general comments.

Do not worry about the credit or points assigned to each question. The relative weights given to the answers will depend on the goals of the data analysis, and we will look at the data in several different ways. We will figure all that out, later.

**\* 2. *What was the important symbol above all of the doorways in the temple?* \_\_\_\_\_.**

**Winged Disk**

	none	half	full
The winged disk.	<input type="radio"/>	<input type="radio"/>	<input type="radio"/>

**\* 3. *What does the Pylon tell us about how the Egyptians wanted the world to be like?***

**perfect....**

	none	half	full
Orderly	<input type="radio"/>	<input type="radio"/>	<input type="radio"/>
Ruled by Egypt	<input type="radio"/>	<input type="radio"/>	<input type="radio"/>
Pharaoh rules Egypt	<input type="radio"/>	<input type="radio"/>	<input type="radio"/>
Pharaoh has the support of the	<input type="radio"/>	<input type="radio"/>	<input type="radio"/>

\*5.

*What happened in the Hypostyle Hall?*

**i don't know.**

	none	half	full
People made a private connection with the divine.	<input type="radio"/>	<input type="radio"/>	<input type="radio"/>
People honored their ancestors.	<input type="radio"/>	<input type="radio"/>	<input type="radio"/>
people saw the connection to the beginning times through the planet-form columns.	<input type="radio"/>	<input type="radio"/>	<input type="radio"/>
Other1	<input type="radio"/>	<input type="radio"/>	<input type="radio"/>
Other2	<input type="radio"/>	<input type="radio"/>	<input type="radio"/>

\*6. *What did Pharaoh do in the Sanctuary? How did the Sanctuary compare with the rest of the temple?*

**it was the most important place, and the pharow aske d the gods for health for his people, and for everyone to be happy.**

	none	half	full
Communicates with the gods.	<input type="radio"/>	<input type="radio"/>	<input type="radio"/>
Makes offerings to the gods.	<input type="radio"/>	<input type="radio"/>	<input type="radio"/>
Entreats the god to let the blessings of heaven flow to the land of Egypt.	<input type="radio"/>	<input type="radio"/>	<input type="radio"/>
Represents the community.	<input type="radio"/>	<input type="radio"/>	<input type="radio"/>
Stands on the ground with the world began	<input type="radio"/>	<input type="radio"/>	<input type="radio"/>

Other1



Other2



**\*7. Tell us one thing you learned from playing with the temple.**

**egyptians made statues that represented their gods, and they were not very together, like they did not let u join the party because u were poor, or rich, or different which i though was nice.**

	low	average	high	N/A
importance	<input type="radio"/>	<input type="radio"/>	<input type="radio"/>	<input type="radio"/>
relevance	<input type="radio"/>	<input type="radio"/>	<input type="radio"/>	<input type="radio"/>
generality	<input type="radio"/>	<input type="radio"/>	<input type="radio"/>	<input type="radio"/>

**8. Please rate these aspects of The student's performance**

	strongly disagree	disagree	neutral	agree	strongly agree	N/A
Student is integrating knowledge from school or elsewhere into his or her answers.	<input type="radio"/>	<input type="radio"/>	<input type="radio"/>	<input type="radio"/>	<input type="radio"/>	<input type="radio"/>
Student is making interesting connections between facts/concepts, showing a higher level learning.	<input type="radio"/>	<input type="radio"/>	<input type="radio"/>	<input type="radio"/>	<input type="radio"/>	<input type="radio"/>
Student is doing a good job of reciting the facts of the temple.	<input type="radio"/>	<input type="radio"/>	<input type="radio"/>	<input type="radio"/>	<input type="radio"/>	<input type="radio"/>
Student has made references to the way that temple, or parts	<input type="radio"/>	<input type="radio"/>	<input type="radio"/>	<input type="radio"/>	<input type="radio"/>	<input type="radio"/>

of it, actually  
look.

**9. Please add any additional comments you have regarding student's answers to these questions. Are there any additional concepts that the student entered? Is there a pattern to the student's answers which are not captured by the grading scheme above?**

Done >>

gods

Other1

Other2

\* 4. *What did people do in the Courtyard?*

**have parties and festivals**

none

half

full

Had great public  
festivals for  
everyone

Dressed simply to  
show their  
humility before  
the gods

Brought their best  
things as offerings

Gave thanks to  
the gods as a  
community

Saw the god and  
pharaoh  
(symbolically)  
embrace in a  
public way

Saw the  
connection  
between heaven  
and earth  
symbolized by the  
open sky of the  
courtyard

Saw how Pharaoh  
made offerings to  
the gods on  
behalf of the  
people.

Other1

Other2

# FOLLOW-UP TEST

Egypt Game Follow-Up [Exit this survey >>](#)

**1. Page One of Two**

\*1. What is your secret name?

\*2. Do you remember playing a learning game (Gates of Horus) on the computer with an ancient Egyptian temple? Select one:

Yes

Maybe

No

\*3. How many people did you tell about Gates of Horus? Select one:

Nobody

1-3

4-10

more than 10

\*4. Just before you left the museum, we gave you a little book about the Temple (the one in the game). Did you read it? Select one:

No.

I looked at the pictures

Yes, I read it.

I read it carefully and more than once.

**5. In the past month, did you see or play with anything else about ancient Egypt? Please select all that apply, if any.**

	Once	Two or three times	Lots
Read part of a book about Egypt.	<input type="checkbox"/>	<input type="checkbox"/>	<input type="checkbox"/>
Saw a movie about Egypt.	<input type="checkbox"/>	<input type="checkbox"/>	<input type="checkbox"/>
Saw a show on TV about Egypt.	<input type="checkbox"/>	<input type="checkbox"/>	<input type="checkbox"/>

Went to the library to look at Egypt books



Talked to somebody who knows Egypt.



Saw a website about Egypt.



Played a game about Egypt.



Made something about Egypt.



\*6. Did you become interested in any of the activities, above, from playing Gates of Horus? Select one:



No, not at all.



I would have done these things, anyway. Playing the game didn't make any difference.



I did some or all of these activities, because I became more interested in Egypt when I played Gates of Horus.

\*7. Did playing the game, Gates of Horus make you any more interested in learning about Egypt? Select one:



No, and I'm not interested in ancient Egypt.



I'm already interested in ancient Egypt and the game didn't make any difference.



I am more interested in ancient Egypt, now, because of the game.

8. Did you actually made something Egyptian or about Egypt? Please tell us what it was.

9. What were the four main areas or pieces of the temple? Check all that apply.



- Pylon
- Nylon
- Forecastle
- Sanctuary
- Dining Hall
- Hypostyle Hall
- Courtyard
- Dome

**10. There were "spirit forms" of Hawks on the ceiling of the Hypostyle Hall. Where did they lead? Select One:**

- Into the temple.
- Out of the temple.
- To the restroom.

**\* 11. In Egyptian belief, what would cause the gods to bless Egypt with good fortune? Select ALL that apply:**

- The devotion of the people.
- Offerings from Pharaoh to the gods.
- Ceremonies performed by Pharaoh or the High Priest
- Nothing. The gods blessed Egypt, regardless

**\* 12. What symbol represented creation, life and especially protection? Select one:**

- The Hawk statues.
- The Winged disk above most door.
- The flagpoles.
- The lamps.

**\* 13. Did the roof of the Hypostyle Hall have square holes in the ceiling? Select one:**

- Yes
- No

\* 14. Like many of the real temple ruins in Egypt, most of the temple does not have much color. Why? Select one:

- It's supposed to be that way.
- Over the centuries, the colors were worn away.
- The Egyptian government spray-painted all the ruins with the sandy/gold color you see.

\* 15. When Pharaoh went before the gods with his offerings and so on, who was he representing? Whose interests was he looking out for? Select one:

- The Egyptian people.
- Himself
- People who were devoted enough to worship in the Hypostyle Hall

16. What was the important symbol above all of the doorways in the temple?

\* 17. The Shrine in the Sanctuary was. Select ALL that apply:

- A magical gateway to heaven.
- The place where the sacred image (statue) of the god stood.
- The point from which the blessings of would flow outward to the land of Egypt.
- Adorned with all the sacred symbols in the other rooms.

Next >>

## 2. Page Two of Two

18. Some of the main areas of the temple are open and sunny (outdoor) while others are dark and mysterious (indoor). For each major area named on the left, select the box which applies.

	Outdoor	Indoor
Pylon	<input checked="" type="checkbox"/>	<input checked="" type="checkbox"/>
Courtyard	<input checked="" type="checkbox"/>	<input checked="" type="checkbox"/>
Hypostyle Hall	<input checked="" type="checkbox"/>	<input checked="" type="checkbox"/>
Sanctuary	<input checked="" type="checkbox"/>	<input checked="" type="checkbox"/>

\* 19. What does the Pylon tell us about how the Egyptians wanted the world to be like?

\* 20. What was the Courtyard for? What did people do here?

\* 21. In the Hypostyle Hall, what do the columns represent and why?

\* 22. How did the Sanctuary compare with the rest of the temple?

\* 23. The temple in our game, Gates of Horus, did not actually exist in Egypt. We made it from parts of which real temple or temples? Select all that apply:

The mortuary temple of Medinet Habu

The temple at Abu Symbel.

- The cult temple of Horus in the town of Edfu.
- The palace of the Scorpion King

\*24. The Egyptians recognized three seasons. What were they? Select ALL that apply:

- Spring, Summer and Fall
- Flood, Growth and Drought
- Earth, Wind and Fire
- Planting, Harvest, Fallow

25. Where is Egypt? Select ALL that apply:

- Northern Africa,
- bordering the Mediterranean Sea
- between Libya and the Gaza Strip
- and the Red Sea north of Sudan

\*26. Why was the temple the only building to be made of stone in a town? Select One:

- The Egyptians built everything from stone.
- So it would be eternal and last forever.
- The Egyptians believed that stone was the flesh of the gods.

\*27. What did Egyptians do in the daily lives that helped unify them as a people. Select ALL that apply:

- Connecting with the gods/goddesses where they lived.
- Remembering to honor their ancestors.
- Reading the Egyptian Bible every day.
- Celebrating good fortune and harvests.
- Drinking beer.
- Honoring the King and the great nobles of their cities.

<< Prev

Done >>

# FOLLOW-UP TEST GRADING FORM

Ace (Follow Up) [Exit this survey >>](#)

## 1. Ace (Follow Up)

\* 1. Grader Name

This grading form is individualized to the above named student. It asks you to evaluate this students' performance on those questions from the Follow Up test which we require human judgment.

In grader-questions 2-6, below , the original student-question appears in italics followed by the students answer. Below that is a list of ideas or characteristics that the student answer may have or contain. Use the button bar to the right to give the student no credit, half credit or full credit for that aspect of their answer. Questions seven and eight have a similar format, them but the grading choices are somewhat different. The last question provide a space for your general comments.

Do not worry about the credit or points assigned to each question. The relative weights given to the answers will depend on the goals of the data analysis, and we will look at the data in several different ways.

***2. Did you actually made something Egyptian or about Egypt? Please tell us what it was.***

**I have made a model of a pyramid in 6th grade but it was prior to playing the game**

	strongly disagree	disagree	neutral	agree	strongly agree
<i>Did the student make something relevant it ain't into Egypt?</i>	<input type="radio"/>	<input type="radio"/>	<input type="radio"/>	<input type="radio"/>	<input type="radio"/>
<i>Was it somehow related to the virtual temple in our game?</i>	<input type="radio"/>	<input type="radio"/>	<input type="radio"/>	<input type="radio"/>	<input type="radio"/>
<i>that it sound like a worthw hile activity?</i>	<input type="radio"/>	<input type="radio"/>	<input type="radio"/>	<input type="radio"/>	<input type="radio"/>

3. *What was the important symbol above all of the doorways in the temple?* \_\_\_\_\_.

**The winged disk**

	none	half	full
The winged disk.	<input type="radio"/>	<input type="radio"/>	<input type="radio"/>

4. *What does the Pylon tell us about how the Egyptians wanted the world to be like?*

**They wanted the world to be organized and orderly**

	none	half	full
Orderly	<input type="radio"/>	<input type="radio"/>	<input type="radio"/>
Ruled by Egypt	<input type="radio"/>	<input type="radio"/>	<input type="radio"/>
Pharaoh rules Egypt	<input type="radio"/>	<input type="radio"/>	<input type="radio"/>
Pharaoh has the support of the gods	<input type="radio"/>	<input type="radio"/>	<input type="radio"/>
Other1	<input type="radio"/>	<input type="radio"/>	<input type="radio"/>
Other2	<input type="radio"/>	<input type="radio"/>	<input type="radio"/>

5. *What was the Courtyard for? What did people do here?*

**All people were allowed here. It was used for prayer and celebrations.**

	none	half	high
Had great public festivals for everyone	<input type="radio"/>	<input type="radio"/>	<input type="radio"/>
Dressed simply to show their humility before the gods	<input type="radio"/>	<input type="radio"/>	<input type="radio"/>
Brought their best things as offerings	<input type="radio"/>	<input type="radio"/>	<input type="radio"/>
Gave thanks to the gods as a community	<input type="radio"/>	<input type="radio"/>	<input type="radio"/>

Saw the god and pharaoh (symbolically) embrace in a public way



Saw the connection between heaven and earth symbolized by the open sky of the courtyard



Saw how Pharaoh made offerings to the gods on behalf of the people.



Other1



Other2



**6. In the Hypostyle Hall, what do the columns represent and why?**

**The ancestors?**

none

half

full

The primeval marsh at the beginning of time.



The environment when the gods lived on the earth.



The reed houses the Egyptians lived in during the predynastic times.



Other1



Other2





**7. How did the Sanctuary compare with the rest of the temple?**

**It was the room that only the pharaoh and high priests were allowed in. It was where the pharaoh (representing the people) prayed and made offerings to the gods.**

	none	half	full
most sacred.	<input type="radio"/>	<input type="radio"/>	<input type="radio"/>
most important.	<input type="radio"/>	<input type="radio"/>	<input type="radio"/>
most exclusive.	<input type="radio"/>	<input type="radio"/>	<input type="radio"/>
the blessings of heaven originate in the shrine and flow outward through the temple.	<input type="radio"/>	<input type="radio"/>	<input type="radio"/>
the highest ground	<input type="radio"/>	<input type="radio"/>	<input type="radio"/>
other-1	<input type="radio"/>	<input type="radio"/>	<input type="radio"/>
other-2	<input type="radio"/>	<input type="radio"/>	<input type="radio"/>

**8. Please add any additional comments you have regarding student's answers to these questions. Are there any additional concepts that the student entered? Is there a pattern to the student's answers which are not captured by the grading scheme above?**

Done >>



**APPENDIX B**

**[TESTING PACKET]**

*Gates of Horus Test Packet for:*

## Child-Appropriate Narrative Explaining Our Study

<b>Begin</b>	<p><i>(We assume the student is already at the designated testing area in the Carnegie Museum of Natural History in Pittsburgh and has a permission form signed by their parents.)</i></p>
<b>Help us</b>	<p>Thank you for coming to see us! We are testing a computer game which is based on a three-dimensional learning game based on an ancient Egyptian temple. We would like you to play with it, take some tests to see how much you've learned, and most importantly tell us how the game could be better. Your opinion and advice are an important part of the study.</p>
<b>Secret name</b>	<p>You will not receive any kind of grade on your results, and we will keep your identity secret. For this we would like you to pick a secret name for yourself. All of your test results will be saved under your secret name and the only connection between your secret name and your real name will be on this permission form, which we will keep under lock and key.</p>
<b>Intake RPM</b>	<p>the first thing you would do is fill out a simple questionnaire with questions like, "How old are you?" "Do you like Egypt?" and things like that. Next you will take a test on visual reasoning, where you try to complete certain geometric patterns.</p>
<b>The Game</b>	<p>At this point most of you will play the game, "Gates of Horus", where you click on parts of the temple to get clues so you can answer the questions that the high priest gives you. If you enough questions right, he will open the gateway into the temple. Then you do similar detective work to answer the questions of another priest who will eventually let you deeper into the temple. When you when you answer all of the last priest questions you win the game.</p>
<b>Maps</b>	<p>After that, we will ask you to draw a map of the temple. Next, we will give you a map of the temple and have you place little magnets in it, to show where things in the temple are supposed to be.</p>
<b>Movie</b>	<p>Next, you will stand up and give us a guided tour of the virtual temple. We will record it with our digital video cam to make a miniature documentary, of sorts. When the study is over, we will mail you a DVD with your tour on it, along with your gift certificate to the museum store.</p>

- Post-Test** Then, you will take a twenty-minute online quiz on the Temple and related topics. Most of you will take this quiz near the end of your first visit here, but some of you will take the test **before** you play the game. If you are randomly
- Controls** chosen to be one of these people, please try to guess your way through the quiz as best you can and use anything you might already know about ancient Egypt.
- Exit interview** Finally, we will ask your opinions about the game and write them down for study. You must understand that you can stop at any time, either to take a quick break, or stop altogether. You participate in the study only so long as you want to.
- Follow-Up** One month later, we would like you to log into a special web site, from any computer on the Internet, and take another quiz. It will tell us what you remember or may have learned about Egyptian temples, in general. Like the other tests, you don't need to worry about how well you do, only that you do it. One to complete the final test, we will mail you a copy of your video on a DVD and a \$5 gift certificate to the museum shop.
- Quite any time** Do you agree with our terms? The whole process takes about one and a half to two hours. You can stop at any time! You can take a break, or you can withdraw from the study at any time, for any reason or no reason.
- sign here** *If they agree:* Please put your secret name on this forum and sign *here* to show that you understand our explanation of the study. We will also need your mailing address on the front of this permission form, as well as your secret name.

*Let them sign their form, put on their mailing address, put their secret name and put the form and their folder.*

## **Pre-Test**

*Take the student to one of the four PCs or either of the two MACs. Launch the pretest from the "Pretest" shortcut icon on the desktop. This test is delivered, via survey monkey, to the student's assigned computer as a series of interactive web pages. The interface employs simple multiple-choice selectors (radio buttons), fill-in-the-blank text fields, and so on.*

## **Raven's Progressive Matrices**

*When the student is done with the pretest, give him or her the RPM book and answer sheet. Explain how to take the test:*

*You will answer questions sets B, C and D. in this book. For each question you will be passed to look at a pattern. Point to the pattern in one of the A-set questions. Figure out which one of these (Point to the six options below the pattern.) completes the pattern correctly. Write the number or letter for your answer on the answer sheet, in the box for that particular question. Make sure they understand how the rows and columns of the answer sheet correlate with the sections in the booklet. Our pilot subjects seem to have no trouble understanding the correct procedure.*

Answer Sheet for

STANDARD PROGRESSIVE MATRICES

J. C. Raven

Sets A, B, C, D, and E

Name ..... Sex ..... Age .....

School ..... Grade .....

Test Begun ..... Test Ended ..... Total Time .....

A	B	C	D	E
---	---	---	---	---

Sample! Do not use, do not duplicate without the warning. Order blanks from Harcourt Press

59 10 A B C D E

12	12	12	12	12
----	----	----	----	----

ISBN 015-468625-5



9 780154 686251

015-4686255

Total Score ..... Percentile .....



A Harcourt Assessment Company

Printed in U.S.A.

*Raven's Progressive Matrices.* Copyright 1938, 1958 by J.C. Raven, © J.C. Raven Ltd 1976. Published by The Psychological Corporation, a Harcourt Assessment Company, by arrangement with J.C. Raven Ltd and Oxford Psychologists Press. All rights reserved.

*Give them at least a minute to move around behind the temple. Ask them to go into cursor mode one or two times to click on features.*

Good Job! Now you are ready to learn how to play the game.

**Start training**

**1**

*Have the student maneuver their view so they tend to see what the two highlighted figures and the priest on the side of the temple. In the Earth Theatre, pressing the "one" key on the keyboard will do this.*

Please left-click on the priest, and he will give you instructions on how to play.

**Coach**

*Hopefully, the student will have no problems during training. After the student clicks on the second figure in the mural, tell him or her up to click on the priest again. Coach the student through any problems they may have. If the student somehow does not perform the correct training sequence and the software causes the parade the priest to merely beep when clicked on, the experimenter will have to complete the priest's instructions.*

**Clues and questions.**

**Prince or Princess**

**2**

*At the end of the training, the priest tells the student to go to the front of the temple to begin play. Ignore this and tell the student, "Every time you click on a clue, the priest will get ready to ask you questions about it. The goal is to answer all the questions for all of the clues in an area so you can move on to the next area. The idea is that you are young prince/princess of Egypt and you spend your childhood in a foreign court like Mesopotamia. Someday you will be Pharaoh, so these priests will help you understand the temple.*

*Press the "two" key on the keyboard. The priest's voice giving the intro speech will begin immediately.*

## **During the Game**

*While the student is working with the pylon, make sure s/he understands how to play the game, and give instructions if you must. In the Earth Theatre, you may comment **twice**, try to get the student to take advantage of the very wide screen. For example, s/he should not constantly fixate the center of their view on every object before they select it, as is required in most first person shooter games.*

*In the other areas, give no further instructions on how to play the game.*

*At any point if the student has spent longer than 60 seconds looking for a clue, usually the last clue out for an area, either tell the student where it is or provide a hint that leads him or her to it.*

## **Presence Test and Maps**

*When the game is done, have the student fill out the questionnaire on the next page, then draw a map of the room there in, draw a map of the temple and place magnetic features on a provided map.*



## Presence and Comfort Test

Student Code: \_\_\_\_\_

While you were playing the game, to what extent did you feel you were *inside* the Egyptian temple. Please pick a number answer, on a scale of zero to ten, based on the key below

- 0 = I did NOT feel like I was inside the temple, at all.
- 1-4 = Maybe I felt like I was in the temple, but only a little.
- 5-6 = I did kind of feel like I was in the temple.
- 7-9 = I had a strong feeling of being inside the temple.
- 10 = I felt like I was totally inside the virtual temple.

Your answer \_\_\_\_\_

For each questions, please select the answer that applies

Do <b>you</b> feel sick?	No	A little	A lot
Does your head hurt?	No	A little	A lot
Do your eyes hurt?	No	A little	A lot
Do you have an upset stomach?	No	A little	A lot
Are you dizzy with your eyes open?	No	A little	A lot
Are you dizzy with your eyes closed?	No	A little	A lot
Are you burping at all?	No	A little	A lot

## **This Room**

On this sheet of paper please draw a very simple map of this physical room with you in it. Just draw the shape of the room as a rectangle/circle, a rectangle for your desk, a circle for you, and rectangles for the doors. All we really want to know is whether *you* know what a map is and how map works.

## **Virtual Temple**

Please draw a map, not a picture but a map, of the virtual Egyptian temple. This should mostly be a simple overhead floor plan.

## **Virtual Temple**

Use this second sheet of paper if you need it.

## Feature Location Test

*Give the student one of the temple maps with the battle backing, and a collection of magnetic cutouts, each one representing a feature of the temple.*

Here's a map of the temple and these little magnets which represent features of the temple. Place the features where they're supposed to go. If you have more than one copy of a particular feature that means they go in more than one place. Sometimes you have a feature like the priest, where there is more than one in the game but you only have one magnet representing him. That just means there are several right places to put him.

*When the student is done, be careful with their map. The magnets can fall off if the map is jostled to roughly*

## Post-Test

*If the student has not already taken the post test, conducted him or her to a workstation to do the test. Start the post test by clicking on the desktop shortcut icon for it.*

## Talking Points for Exit Interview

The following points are the basic forms of the statements and questions the investigator will present to the child during the exit interview. The investigator is *not* bound to the precise wording or order shown here—that will depend on the investigator’s discretion and the student’s responses. We will allow five minutes.

- Is there anything you want to tell us about the game? What did you think of it?
- Do you have any suggestions on how to make the game better?
- Here is a printed article about ancient Egyptian temples for you to keep. It tells you more about this temple and has links to interesting web sites about Egypt.
- Thank you again for being a part of our study! One month from now we will send you a reminder letter asking that you take the second quiz. Once you have done that we will send you a DVD with your tour of the temple on it, and the \$5 gift certificate.

**APPENDIX C**

**[TEMPLE BOOK]**

## THE VIRTUAL EGYPTIAN TEMPLE

Dr. Lynn Holden  
& Jane Vadnal



The game, "Gates of Horus", takes place in a Virtual Reality model of an ancient Egyptian temple. The object of the game is to explore the model and gather enough information to answer the questions asked by the priest who stands at the doorway leading to the next part of the temple. If you answer them correctly, you will be allowed to pass through the doorway until you reach the innermost chamber, the sanctuary of the god of the temple. You will win the game if you answer the final questions and hear the wisdom of the god.



This model is based on the ruins of two of the best-preserved Egyptian temples from the time of the Egyptian kings (Pharaohs). The first is an earlier New Kingdom (c. 1100 BCE) Mortuary Temple at Thebes in Upper Egypt, called Medinet Habu. The other, later temple is a City (Cult) Temple in the important Upper Egyptian center of Edfu, dedicated to the Hawk-God Horus, the patron of Kingship: it dates from about 150 BCE. These two temples were among the largest and finest in all of Egypt and represent great wealth and power at the local level. The temple is simplified having only enough detail to represent the essential elements found in real Egyptian temples. For example, there is only one of each of the four types of areas, while an actual temple might have had several Courtyards and Hypostyle Halls. Similarly, the hieroglyphics are larger than they would be in an actual temple, to make them more legible. Nevertheless, the scale and proportions of the spaces are correct, hieroglyphics make the appropriate statements, the images are in proper locations and so on. In this way, the physical form and dimensions of the temple symbolize the archetypal elements of ancient Egyptian culture, which evolved over many millennia.

The purpose of the game is to introduce you to the architecture of an ancient Egyptian Temple. This pamphlet is designed to give you some background about the temple. We will first give an overview of the parts of the temple, then look at some of the factors that shaped Egyptian architecture as a whole. Finally, we will look at the overall role of the temple in Egyptian society.

### **General Characteristics of the Temple**

Not every community had a temple: some temples served several communities. The temple was usually located at the heart of a town or city. Leading to the temple was a sacred road, usually lined with statues – often sphinxes, the life-giving animal form of the deity protecting the king. This road was the site of elaborate processions on special occasions, such as the arrival of the king.

Though most Egyptian architecture was built of mud-brick, temples were generally made of stone, so that they would be eternal, and endure forever. They were usually oriented towards the east, so that from the interior, the sun would be seen to rise between the rectangular towers of the entrance Pylon. Because of this alignment, the light would, at special times, stream into the interior through specially sited openings to illuminate the images of the gods and the kings.

The forms of ancient Egyptian buildings often display a striking harmony with the shapes of Egypt's natural environment. The forms of the temple echo the horizontal lines and rectilinear textures of the cliffs



of the Nile Valley, and the mounds and pyramidal masses of the desert that surrounded it. An example of this is the Mortuary Temple of Queen Hatshepsut at Deir el Bahri, shown above. The colors of the stone used to build the temple

and the paintings decorating it reflected the colors of the landscape as well. This connection with the environment is one of many manifestations of the ancient Egyptians' love of harmony and balance.



Temple interiors were richly decorated with scenes from the stories of the lives of the gods and of the kings. The ceilings were usually carved with stars and painted blue to imitate the sky, sometimes adorned with flying vultures and hawks, or personified stars and constellations in boats sailing on the celestial Nile (the Milky Way). These scenes are almost always highly organized into structured registers with base lines, and the figures themselves arranged with the help of painted grid lines. The size and association of figures is also revealing, with the largest figures in a scene being the most important, and usually being attended by ranks of smaller figures.

Like the architecture of the temple, the art within it was highly stylized and very traditional. It consisted of simple but effective shapes contained within an outline. The human figure was represented in a functionally stylized manner with the head, waist and arms and legs in profile to allow indication of action and movement, but with the shoulders and the eye of the face seen from front view to show details of the crowns, jewelry and clothing.

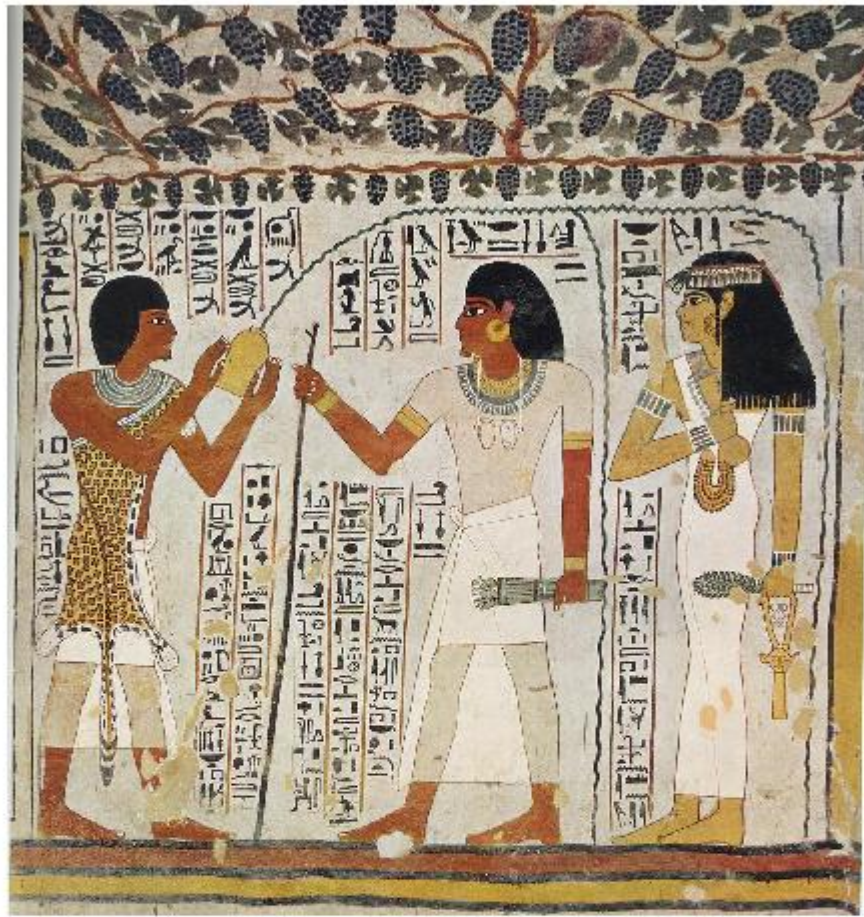

The color palette was very simple ~ red (ochre - iron oxide), yellow (yellow ochre), green (malachite), blue (copper salts), brown (dark ochre), black (carbon) and white (gypsum), but used very powerfully to convey vibrancy and contrast. Hieroglyphics often appeared in the scenes as well, which made them even more stylized.



A wall of mud brick surrounded most temples. Other buildings were often associated with the temple – many of these had what we would consider non-religious purposes. For example, many temples had large storehouses for grain, which was collected in times of plenty and distributed in times of scarcity – for times when crops failed because the annual Nile flood was too high or too low. Also, most temples had a “House of Life” – a center for education and a place where texts were stored. These texts contained not only descriptions of religious beliefs and rituals, but also literature and historical accounts – the Egyptians were particularly fascinated with history. The “House of Life” texts also included legal and governmental records. Land records were especially important, because landmarks could be washed away during a particularly high Nile flood. In addition to buildings, temple grounds often included a sacred lake, where purifications were performed and myths were enacted, as well as sacred groves and gardens.

### The Parts of the Ancient Egyptian Temple

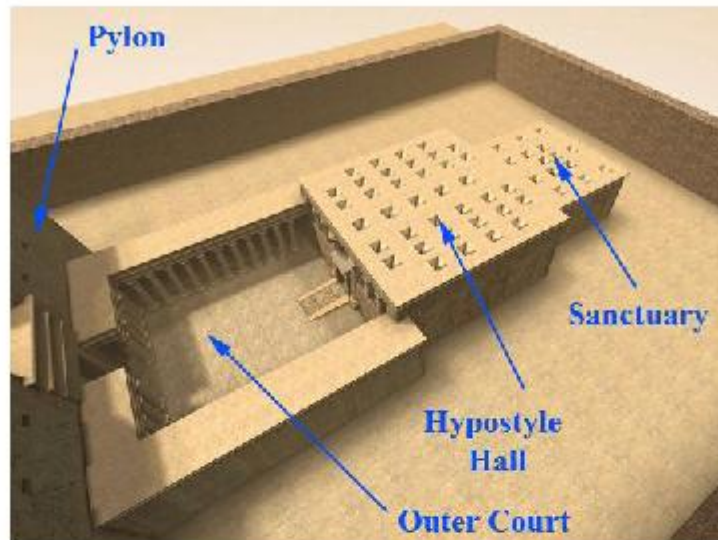

The sacred precinct of the temple contains four primary areas: the entrance through a massive facade or Pylon, the Outer Court open to the sky and surrounded by a colonnade, the covered hall called the Hypostyle Hall, and finally an Inner Sanctuary, where a statue of the divinity was enshrined.

### The Pylon

There were often large stone statues standing on either side of the entrance to the temple. Sometimes they were colossal seated or standing stone statues of patron kings, which were often 30 to 60 feet high. Sometimes they were obelisks – massive pointed square shafts of stone, usually 70 to 110 feet tall. In other temples, these statues were symbols of the god of the temple. In our temple, we used statues of hawks, the symbol of the god Horus.



The front of the temple itself was called the Pylon – two large cubic shapes with slightly slanting walls, connected by a monumental gate. Above is a picture of the Pylon of the real Temple of Horus in the town of Edfu, in Egypt. From the start of the New Kingdom period, 1500 BC, the Egyptians built many of their temples with the pylon of this type.

The left and right halves of the Pylon symbolized the mountains to the east and west of the Nile valley (called the “Heavenly Horizon”), between which the sun was thought to travel each day. They also were associated with the throne of Egypt: thus, they were the location of special ceremonies related to the coronation of the king. The blocks were frequently decorated with tall imported coniferous-wood masts; colorful banners were suspended from them. The exterior faces of the two entrance blocks were usually decorated with carved figures of the king and the gods of the temple in scenes of military victory and triumph. The figures of the king could be more than 30 feet tall and were usually shown defeating the traditional enemies of Egypt in front of the main god of the temple. Often, the god was shown offering symbols of victory and power to the king – symbols such as

swords, scepters, or the Sacred Feather of Truth.

The monumental gateway in the center of the Pylon was called “the Bridge of Horus.” Horus, whose name meant “He who is above.” was the god of the sky and of kingship. The gate was fitted with massive cedar-wood doors 60 feet tall, often decorated with gilded images of the king and gods. Townspeople could offer their prayers at a special chapel of the gateway. The exterior of the Pylon was also the site of important public ceremonies affirming the power, goodness, and military valor of the king of Egypt.

### **Outer Court**

The first space inside the gateway was a large Outer Court that was open to the sky. Such Courts usually had a covered walkway supported by columns on each side. Altars and colossal statues stood between the columns. The paintings and carvings on the walls and columns usually included displays of the greatness of the sacred Name of the king, and colorful scenes showing the king worshipping the gods and receiving blessings and power.



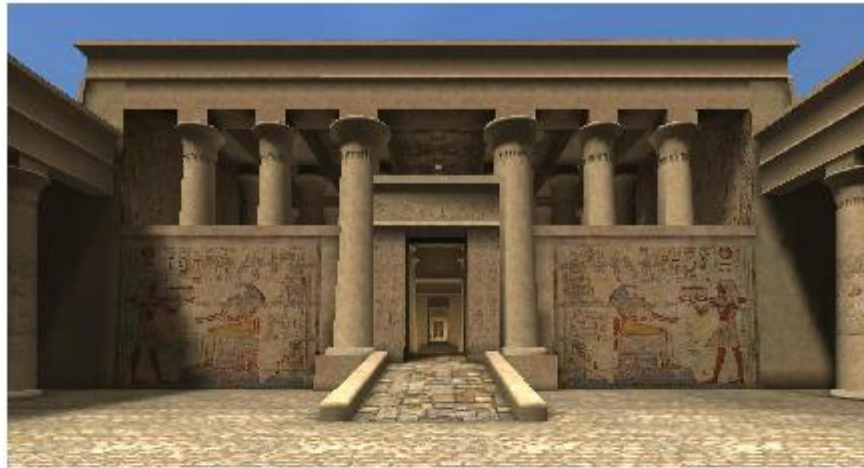

The Outer Court was a public space used for many kinds of ceremonies. Sacred oracles took place here; they were often used to settle local issues or disputes. The Outer Court was also the site of seasonal festivals held every year. During many of them, sacred mystery plays were performed, dramatizing local and national myths. Pilgrims came from all over Egypt to take part in the festivals of the most important local, regional and national temples. At these events ordinary people could interact with their leaders, including the “Divine King” himself.

### **Hypostyle Hall**

The next room is the large, enclosed Hypostyle Hall. A forest of massive columns, up to 60 feet tall, supported the roof. They were usually decorated with plant-form capitals (papyrus, lotus, palm, etc.) representing the physical environment of Egypt at the beginning of time when the ancient Egyptians believed the gods lived on the earth. The Hypostyle Hall was dimly lit by

small windows in or near the ceiling, recalling the gloom of a dense thicket. The decoration painted and carved into the walls of the Hypostyle Hall showed the king performing important ceremonies that guaranteed the unity, security and prosperity of the land and its people. Usually there were life-size statues and offering places between the columns to commemorate important patrons and ancestors of the local community.



Only the Initiated were allowed to worship in the Hypostyle Hall. Every day the professional priests of the temple would perform the daily ritual of the temple, which maintained the daily life and routine of the god and his family. One important example was the Reversion-of-Offerings ceremony, where the daily offerings to the god were divided up and reused for the benefit of the ancestor kings, patrons and local heroes, who were represented by statues in the Hypostyle Hall. (Eventually the priests ate the food-offerings – they regarded them as part of their temple income-wages).

## Sanctuary

The innermost chamber was the Sanctuary, the most important and sacred place in the Temple. The Sanctuary represented the "Original First Place" (or Primeval Mound), which came forth from the "Primeval Flood" at the beginning of time. This is where the first god came down to earth. Only the king himself, or his local representative, the High Priest, could enter the sanctuary.



The sanctuary was very dark. It contained a large shrine, supported on a stone pedestal and containing a statue that was the "Living Image" of the deity to whom the temple was dedicated. The walls of the sanctuary were usually decorated with paintings and sculptures depicting ritual activities, along with other very intimate interactions between the king and the Great God. These

interactions were believed to guarantee the peace, prosperity, stability and continuity of the land and people of Egypt. The floor of the sanctuary was covered with special fine, pure sand – there was a special ritual when the king or high priest swept it clean of footprints at the end of each ceremony.

Around the sanctuary were smaller rooms to store ritual equipment and supplies for the essential ceremonies. One of the most important of these was a large wooden model boat, which was often gilded and elaborately decorated. It was used to carry a statue of the deity out of the temple at times of festival or pilgrimage. Since most long-distance travel in ancient Egypt took place on boats on the Nile, it was natural to think that deities traveled by boat as well.

#### **Other Types of Egyptian Temples**

The temple in “Gates of Horus” is a model of a community temple. However, there were other types of temples in Egypt. The most common was probably the Mortuary Temple, which were sometimes called “mansions of millions of years”. These were memorial monuments, dedicated to the memory of one particular person, usually a King or local patron or hero. Sometimes, mortuary temples were associated with tombs and pyramids. A Mortuary Temple was located away from the center of the community, usually near a Sacred Mountain or the West side of the Nile – the side of sunset, where at the end of every day the sun god Ra descended into the Underworld. Though the visual forms of the decoration and ceremonies were similar to those seen in the City Temples, a mortuary temple was less universal in its functions and community roles. There were other, specialized temples as well, such as coronation temples and others.

## **Egyptian Architecture**

We have been taught think about architecture using the concepts of form, function, and beauty – categories proposed by the Roman architect Marcus Vitruvius Pollio. However, for the ancient Egyptians, these three concepts were all aspects of the same thing. The Egyptians did not divide up ideas into separate analytical categories, but were very interested in harmony, balance, and the relationship of the parts to each other and to the whole. For example, in the Egyptian language, the words describing the concepts of beauty, power and harmony/stability are interchangeable. To the Egyptians, beauty in a temple referred to the visual and functional harmony of the human activities that were always going on within it. The endless offering ceremonies, the prayers and chanting, were shaped by the form of the building and by the carving and painting within it. All were manifestations of the eternal cycles of creation, growth and transformation that were at the heart of Egyptian beliefs. The architecture of Egyptian temples was also strongly influenced by tradition and by symbolism; factors that have very little place in our own architecture.

Tradition had a central place in Egyptian society and art. The physical forms of religious architecture and their artworks and decoration were mostly developed very early in Egypt's history. By the later Old Kingdom (2500-2300 BCE) mature prototypes for most themes existed and were maintained faithfully for over 2500 years thereafter. Egyptian history contained long periods of peace and prosperity, such as the Middle Kingdom (c 1990-1750 BCE), the New Kingdom (c 1550-1085 BCE) and the Late Period (664-332 BCE). But there were times when Egyptian society was disrupted by environmental factors and by the political ambitions and mistakes of individuals. In some of these periods, parts of Egypt were attacked and occupied by other, newer civilizations, which

had developed in the Middle East and the Mediterranean. Paradoxically, these times of instability made the traditional forms stronger rather than weaker. For one thing, the invaders adopted the traditions of the Pharaohs to consolidate their power; these new foreign rulers are often represented on temple walls in Egyptian costume, worshipping Egyptian deities. Instability strengthened tradition in another way as well. Every time Egypt was peaceful, unified, and prosperous, the Egyptians rediscovered and revived their old traditions. This continuity was a way of asserting Egyptian peace, posterity and power.

The ancient Egyptians valued the essential symbolic functions of architecture, which addressed their feelings, needs and beliefs and maintained the identity and continuity of their spiritual character. Major sources of this symbolism included the natural environment, the common human daily activities of that time, and the Egyptian understanding of the afterlife and the cosmos. Often these symbols had complex, multiple meanings, depending on the context. For example, the hawk was the symbol of power and light, but also clarity of purpose, and royalty. It was associated with several gods, including Re, Horus, and Kohnsu, the god of the moon.

One major source for this symbolism was the Nile, which the Egyptians called 'the Great River'. This mighty river originates in Central Africa at Lake Victoria and flows almost straight north to the Mediterranean Sea, almost 3,000 miles away. About 700 miles from the sea, the Nile encounters a region with very hard granite, which has created ten areas of very rough rapids. In ancient times, the most downstream of these was seven miles long and was called the First Cataract or the Great Cataract.





These rapids cut off Egypt from the southern part of the Nile and from southern Africa. North of the Great Cataract, the Nile encountered much softer rock, and, over millions of years, carved out a deep river valley called Upper Egypt. It is very narrow – 15 to 30 miles in most places – and is cut off from the surrounding desert by high cliffs. For an idea of the size of the cliffs, see the image above of Queen Hatshepsut's temple at Deir el Bahahri. These deserts and cliffs made it very difficult for enemies to invade Upper Egypt. The silt carried by the Nile created a large delta called Lower Egypt that extended into the Mediterranean Sea.

The yearly cycle of the Nile shaped the daily activities in ancient Egypt. Sometime between April and June the water level of the Nile began to rise, swollen by the runoff from the rainy season in tropical Africa. Before the

advent of modern dams, it rose 40-45 feet in Upper Egypt and 25 feet in the Nile Delta. For four months, Egypt became a shallow lake, with only the towns and villages, which were built on mounds, rising above the waters. This was the season of Akhet, the inundation. When the waters receded in October or November, the landscape was covered with a layer of rich black silt. Akhet was followed by four months of weather that was ideal for agriculture. This season, called Peret (emergence or growth) was a time of intense cultivation, when crops (emmer wheat at first, later other kinds of wheat, barley, flax and a variety of vegetables) could be planted, weeded, and cultivated. The image at



left shows a farmer plowing with oxen. Harvest came at the beginning of the next season, Shemu (drought), which was extremely hot and dry. But even this dryness had benefits – it prevented waterlogging, the growth of mold and the build-up of excessive salt in the soil.

The climate in Egypt is subtropical and the vegetation is lush and diverse. The fertility of the soil gave them great prosperity and stability. Many parts of this natural setting – the landscape of the river valley, the plants and animals who lived there, the sky above them – were mirrored in the temple and used as symbols of aspects of both everyday and religious life. The natural setting was integral to the Egyptian world-view in other ways, too. Scholars such as Nadler have pointed out that Egypt was a land of great natural contrasts. The desolate, searing desert was never more than a few miles from the lush, crowded Nile valley with its tightly knit communities. The yearly cycle of the Nile, with its oscillation between 40-foot high floods and times of drought, was extreme as



well. The Egyptian love of balance and harmony was not because their lives were bland and comfortable, like our own, but because they had to face and reconcile extremes. As Nadler says

In Egypt, one is constantly impressed by the balance and interplay of the opposites: life and death, abundance and barrenness, light and dark, day and night, society and solitude. Each is so clearly described that one sees that the ancient Egyptians could not but understand the world in dualistic terms. Their landscape teaches the metaphysics of the equilibrium of opposing principles. (Nadler, p. 8)

This awareness gave a sort of tension to the Egyptian quest for harmony and balance. The contending forces were real and powerful, and were not going to go away. Harmony was precious and must be constantly struggled for. Perhaps this is why the Egyptian system lasted so long.

This struggle can be seen in Egyptian architecture. There were constant contrasts – between horizontal and vertical, dazzling light and deep darkness, huge masses and tiny, exquisite details – that were balanced and made into a harmonious whole.

Everyday life had its place in the symbolism of the temple as well. Temples and tombs were “homes” for divine spirits and beings. The formal buildings and the activities within them were religious elaborations of common human daily activities, which were stylized and extended to do honor to the importance of the gods and goddesses enshrined within them. For instance, in the innermost sanctuary, the statue that was thought to contain part of the god’s or goddess’s essence was “awakened” each morning by music, purified, anointed, dressed, and symbolically “fed” with food later consumed by the priests. In the evening, this process was reversed, and, at the end, the god or goddess was sung a lullaby.

Of course, religious beliefs were another source of the symbolism that pervaded the temple. Temples were believed to be eternal manifestations of the Heavenly Horizon on earth. Each town believed that its temple was built on the spot where the Primeval Mound arose out of the chaotic floodwaters that covered the earth at the beginning of time. This "High Place" depicted as a mound or pyramid, was the site where the gods first came down to earth and separated light from dark, good from evil and created human life. The annual flood cycle of the river Nile was believed to reenact this event every year. This belief in the Primeval Mound was symbolized in many ways in the architecture of the temple. For example, as you walk into the temple, the room floor levels ascend while the ceiling heights descend. Many of the columns were circular with plant-form capitals. When clustered together in a Hypostyle Hall, the effect was of the light filtering through natural thicket, the imagined original environment of Egypt at the beginning of time. Above is the Hypostyle Hall at the Temple of Amon at Karnak.

### **The Temple in Egyptian Society**

If a time-traveler from Ancient Egypt were shown the motherboard of a computer, he or she would find it a beautifully crafted piece of metal and ceramic. He or she would not know that it is the core of a machine which is a major tool for commerce and for learning, which connects people all over the world, and which performs other functions that he or she would find unimaginable. In the same way, if you were to visit an ancient Egyptian temple, you would marvel at its architecture and the painting and sculpture within it, but you would not understand how temples like it functioned as the heart of the Egyptian community.

The temple was the house of the local god or goddess where rituals served to praise and honor the gods and the kings, and thus to bring peace and prosperity to the land of Egypt. The temple was the largest building in the town and the only one built of stone. Its architecture and the content and style of its decoration were traditional and symbolic – some forms and styles were unchanged for over two thousand years. It was the focal point for pilgrimages and for rituals.

Festivals at the temple were common: some of them acted like our modern weekends, as a break from work, providing time for special acts of piety and for family gatherings to honor ancestors. Others marked important events in the Egyptian calendar – such as the New Year, the beginnings of the seasons, the birthdays of the gods, and the coronation day of the king. People from all levels of society met and interacted at the temple for festivals and other occasions. Adults and children, kings (called Pharaohs) and beggars, farmers, aristocrats, traders and priests all had roles in the rituals, celebrations, and daily activities of the temple.

Each year, every able-bodied person in the local community was required to do one month of service to their local temple. This service took many forms – sometimes maintaining the temple, sometimes making objects in the workshops attached to it, sometimes working on land donated to the temple. Some men even served as “lay-priests.” They purified themselves by ritual bathing, shaved their bodies (including their eyebrows), and performed priestly duties for one month and then returned to their homes and families. This requirement insured that the temple was integrated into the community and into the daily lives of the Egyptians to a much greater degree than we are accustomed to today.

The temple was the location of many different kinds of activities that in modern society are scattered in separate places. We worship in churches and temples, we celebrate in homes and public places, our business decisions are made in corporate offices,



we study science and literature in our schools and universities, our political and judicial decisions are made in courthouses and government buildings. In ancient Egypt, all these, as well as activities that we do not have in our society, were performed in the temple.

These activities not only shared a common site, but also, as we will see, had common assumptions, symbols and goals in a way that our institutions do not. In addition, temples were the nodes that connected local communities to their region and to the country as a whole. The temple also helped connect the mass of the people with the Egyptian state. Many priests served as government officials on the local, regional, and national levels. The priest also had other, less formal, duties, which linked the local community with the wider world. For example, priests informally evaluated the children in the village(s) under their care. Those who showed particular talents in any area – for instance, art or mathematics or leadership – were sent to the regional temple for further education. The most talented children were taken to the capital, where the most

promising of them were educated with the children of the Royal Family. The local priests would also watch for people who were restless or troublemakers, or resentful of the tightly knit village communities. These were sent off to the army or away on trading or mining expeditions.

The religious beliefs embodied in the temple also helped unite Egypt. This is not to say that the Egyptians had only one god – they had very many (a few are shown below).



Some gods were great universal cosmic creators and personifications of the forces of nature, such as the sky, the earth, the sun and moon, air and water, etc. Another important class of deities was related to special places like sacred mountains, springs or groves of trees, and in later times provinces, cities and towns. In addition, individuals and families had personal gods and goddesses often determined by profession or place in society, as well as ancestor spirits similar to those worshipped in the Far East today. However, unlike other societies, the great number and variety of gods and goddesses did not lead to

religious strife. Instead, they were seen as parts of a large, shifting interconnected sacred family. Exceptional humans (most notably the king) could be part of this family as well. In addition, the Egyptians had a concept known as syncretism, through which the attributes and powers of different deities could be linked or even merged for a specific purpose without losing their individual identities in their home temples. For example, Amen, the creator god worshiped at Thebes, and Re, the sun god, were merged to become Amen-Re the “King of the Gods.” Amen, Re, and Amen-Re were all worshiped at their own temples. This flexibility allowed Egyptians to harmonize the ideologies of different regions as time passed and one or another regional god became politically dominant and took on the role of State-God.

### **Conclusion**

The City Temple stood at the heart of the local community. It performed many different functions – political, economic, educational, and religious. The architecture of the temple and the way the temple interacted with the community reflected the ancients’ understanding of the nature and organization of the universe and their place in it. The components of the temple not only reflect the elements of Egypt’s dramatic physical setting, its local and national culture, and the complex interaction of its many gods and goddesses, but also illustrate the underlying contradictions and tensions of Egypt and the harmony and balance that Egyptian society used to reconcile them.

**APPENDIX D**

**[OTHER MATERIALS]**

# PERMISSION FORM



University of Pittsburgh

*Department of Information Science  
and Telecommunications*

135 North Bellefield Avenue  
Pittsburgh, PA 15260  
412-624-9400  
Fax: 412-624-2788  
www.sis.pitt.edu/~dist/

Approval Date:  
Renewal Date:  
University of Pittsburgh  
Institutional Review Board  
IRB Number: 0607073

## CONSENT FOR A MINOR TO ACT AS A SUBJECT IN A RESEARCH STUDY

**TITLE:** Ancient Architecture in Virtual Reality:  
Does Visual Immersion Aid Learning?

**PRINCIPAL INVESTIGATOR:** Jeffrey Jacobson, Doctoral Candidate  
135 North Bellefield Ave., Pittsburgh, PA 15260  
Phone: 412-401-4311  
e-mail: jeff@planetjeff.net

**CO-INVESTIGATORS:** Kerry Handron, Director, Earth Theater  
4400 Forbes Avenue, Pittsburgh, PA 15213  
Phone: 412-578-2580  
e-mail: HandronK@CarnegieMuseums.org

Dr. Michael Lewis, Full Professor,  
Mr. Jacobson's academic advisor.  
135 North Bellefield Ave., Pittsburgh, PA 15260  
Phone: 412-624-9426  
e-mail: ml@sis.pitt.edu

Dr. Lynn Holden  
Per Ankh Studios, Toronto, Canada.  
e-mail: lholden1@sprint.ca

**SOURCE OF SUPPORT:** No External Funding

Parent's Initials : \_\_\_\_\_

1



**Why is this research being done?**

We wish to see if a very large computer display, one that fills most of the user's view, will help children learn more from 3D computer-graphic representations of complex spaces.

**Who is being asked to take part in this study?**

Approximately 100 middle-school students from the greater Pittsburgh area.

**What are the procedures of this study?**

If your child participates in this study, your child will

- 1) fill out a questionnaire asking general information about him/her and then spend fifteen minutes solving abstract visual puzzles
- 2) do a training exercise on how to navigate "in" a 3D computer world
- 3) play an interactive learning game based on 3D ancient Egyptian temple.
- 4) give *us* a short guided tour of the temple, which we will record.
- 5) will draw maps of the temple and take a short quiz
- 6) one month later, log into a special web site and complete the second quiz. At that time, we will send you and your child a reminder of the second quiz by physical or electronic mail.

We expect the initial testing (steps 1-5) to take two hours, including breaks. The second quiz will take twenty minutes.

**Where?**

You will bring your child to the Carnegie Museum of Natural History. We will supervise him/her during the testing period and as long as s/he stays in the designated testing area, which we will show you. You are always welcome to accompany your child during testing, so long as you do not interfere with the tests.

**Who is eligible for the study?**

Your child must be in sixth, seventh or eighth grade at an accredited middle school **and** between eleven and fourteen years old.

**What are the possible risks and discomforts of this study?**

A small number of children may experience motion sickness from watching a movie in a standard movie theater, especially by sitting near the front. If your child has this problem, s/he may experience discomfort while playing our learning game on the big-screen computer. If that happens, we will immediately turn off the screen and have your child sit down. We will terminate his/her participation in the study and return him/her to your care.

If your child expresses boredom or dislike for the current procedures, we will offer him or her a break if possible. (Some procedures, like game-play, cannot be interrupted without ending participation in the study, while some can.) At the end of the break we will ask him or her whether s/he wishes to continue. At this or any other time, s/he may withdraw from the study.

An accidental breach of confidentiality is also possible. To reduce the likelihood of a breach of confidentiality, all researchers have been thoroughly trained to maintain your privacy.

Parent's Initials : \_\_\_\_\_

2

***Will my child benefit from taking part in this study?***

There is no guarantee that your child will receive any direct benefit from participating in this study. However, s/he may have some fun and learn something about ancient Egypt.

***Are there any costs to me if my child participates in this study?***

You pay nothing.

***Will we be paid if my child takes part in this research study?***

Upon arrival at the museum, you and s/he receive a free all-day admission to the museum. After the first round of testing, your child will receive copies of the temple maps s/he made, and a small book containing more information on Egyptian temples and culture. If s/he completes the online knowledge quiz one month later, we will mail you a copy of his/her guided tour on DVD and a \$5 gift certificate to the museum gift shop. A few months later, we will mail you a reference (web address) to the overall results of the study.

***Will anyone know my child is taking part in this study?***

All records pertaining to your child's involvement in this study are kept strictly confidential (private) and any data that includes you or your child's identity will be stored in locked files at all times. All information we gather from completion of the learning game and completion of the questionnaires will be labeled with an assigned ID code. Neither your child's name nor any other identifying information will appear on these records. When we report our findings in publications or other venues, we will say nothing that may allow a third party to infer the identity of your or your child. Also, we will protect the video recording (a DVD) of your child's tour of the temple along with his/her personal data, in locked files. We will not show it to any other party without your explicit permission. We will keep the personal information and video recordings for at least five years, as required by University of Pittsburgh Policy.

In unusual cases, your research records may be released in response to an order from a court of law. It is also possible that authorized representatives from the University of Pittsburgh Research Conduct and Compliance Office, or the University of Pittsburgh IRB or the administration of the Carnegie Museums of Pittsburgh may review your data for the purpose of monitoring the conduct of this study. Also, if the investigators learn that you or someone with whom you are involved is in serious danger of potential harm, they will need to inform the appropriate agencies, as required by Pennsylvania law.

***Is participation in this study voluntary?***

Yes! Your child's participation in this study is completely voluntary. S/he may refuse to take part in it, or stop participating at any time, even after signing this form.

***How can I get more information about this study?***

If you have any further questions about this research study, you may contact Jeffrey Jacobson at 412-401-4311 or email: jeff@planetjeff.net, or contact Kerry Handron at 412-578-2580 or email: HandronK@CarnegieMuseums.Org. If you have any questions about your child's rights as a research subject, please contact the Human Subjects Protection Advocate at the University of Pittsburgh IRB Office, 1-866-212-2668.

Parent's Initials : \_\_\_\_\_

3

**Parental Certification For \_\_\_\_\_**

*Child's Name*

I understand that, as a minor (age less than 18 years) the above named child is not permitted to participate in this research study without my consent. Therefore, by signing this form, I give my consent for his/her participation in this research study.

The above information has been explained to me and all of my current questions have been answered. I understand that I am encouraged to ask questions, voice concerns or complaints about any aspect of this research study during the course of study, and that such future questions, concerns or complaints will be answered by a qualified individual or by the investigator(s) listed on the first page of this consent document at the telephone number(s) given. I understand that I may always request that my questions, concerns or complaints be address by the IRB Office, University of Pittsburgh (1-866-212-2668) to discuss problems, concerns, and questions; obtain information; offer input; or discuss situations in the event that the research team is unavailable. By signing this form I agree to my child's participation in this research study. A copy of this consent form will be given to me.

\_\_\_\_\_  
*Parent Signature*

\_\_\_\_\_  
*Date*

This research study has been explained to me and I agree to participate.

\_\_\_\_\_  
*Signature of Child-Participant*

\_\_\_\_\_  
*Date*

**Verification of Explanation**

I certify that I have carefully explained the purpose and nature of this research to (name of child) in age appropriate language. He/she has had an opportunity to discuss it with me in detail. I have answered all his/her questions and he/she provided affirmative agreement (i.e., assent) to participate in this research.

\_\_\_\_\_  
*Principal/Co-Investigator Signature*

\_\_\_\_\_  
*Date*



# University of Pittsburgh

*Department of Information Science  
and Telecommunications*

135 North Bellefield Avenue  
Pittsburgh, PA 15260  
412-624-9400  
Fax: 412-624-2788  
[www.sis.pitt.edu/~dist/](http://www.sis.pitt.edu/~dist/)

<current date>

<name of the student>

c/o <student's parents' names>

<student's physical or electronic mailing address>

Dear <child's name>,

About three weeks ago you came to the Carnegie Museum of Natural History and played Gates of Horus, our puzzle game with the Virtual Egyptian Temple and the Priest who asks you all the questions.

We respectfully ask if you would be willing to a twenty minute quiz about Egyptian temples. You can do it any time on any computer connected to the world wide web. Just go to this web site and follow the instructions:

<give URL>

Remember the guided tour of the temple we recorded just after you played with the temple in the museum? If you will complete this quiz, we will send you a recording of your tour your tour along with a \$5 gift certificate to the Carnegie Museum store. If you possibly can, please complete this quiz within five days of receiving this letter.

Your answers to the quiz will help us to better understand how kids learn, so we can make more and better games and museum exhibits like the one you played with. Thank you again for coming to visit us the first time, and we look forward to your quiz answers. If you have any questions, please e-mail us or call.

Warm Regards,

Jeffrey Jacobson  
412-401-4311  
[jeff@planetjeff.net](mailto:jeff@planetjeff.net)

Kerry Handron  
412-578-2580  
[HandronK@CarnegieMuseums.org](mailto:HandronK@CarnegieMuseums.org)

cc: Mr. & Mrs. <parents' names>

## EGYPT FOLLOW-UP LETTER

*<Put this on CMNH letterhead.>*

*<current date>*

*<name of the student>*

*c/o <student's parents' names, if available>*

*<student's physical or electronic mailing address>*

Dear *<child's name>*,

About three weeks ago you came to the Carnegie Museum of Natural History and played Gates of Horus, our puzzle game with the Virtual Egyptian Temple and the Priest who asks you all the questions.

We respectfully ask if you would be willing to a twenty minute quiz about Egyptian temples. You can do it any time on any computer connected to the world wide web. Just go to this web site and follow the instructions:

<http://publicvr.org/egypt.html>

Remember the guided tour of the temple we recorded just after you played with the temple in the museum? If you will complete this quiz, we will send you a recording of your tour your tour along with a \$5 gift certificate to the Carnegie Museum store. If you possibly can, please complete this quiz within five days of receiving this letter.

Your answers to the quiz will help us to better understand how kids learn, so we can make more and better games and museum exhibits like the one you played with. Thank you again for coming to visit us the first time, and we look forward to your quiz answers. If you have any questions, please e-mail us or call.

Warm Regards,

Jeffrey Jacobson  
412-401-4311  
jeff@planetjeff.net

Kerry Handron  
412-578-2580  
HandronK@CarnegieMuseums.org

## GIFT CERTIFICATE LETTER



University of Pittsburgh

*Department of Information Science  
and Telecommunications*

135 North Bellefield Avenue  
Pittsburgh, PA 15260  
412-624-9400  
Fax: 412-624-2788  
[www.sis.pitt.edu/~dist/](http://www.sis.pitt.edu/~dist/)

wnn

02/08/07

Dear Young Pharaoh-To-Be,

Thank you ever so much for participating on our learning study at the Carnegie Museum of Natural History. Your answers and suggestions will help us to understand how people learn and how to improve our computer learning game, Gates of Horus. We hope you had fun.

Please accept this \$5 gift certificate to the Museum Store at Museum of Natural History and a copy of the video you made. We apologize for taking so long to get these to you. We hope you will come again to the Earth theater for our other activities.

When the study is complete, we will let you know how it turned out.

Best Wishes,

A handwritten signature in cursive script that reads "Jeffrey Jacobson".

Jeffrey Jacobson  
412-401-4311  
[jeff@planetjeff.net](mailto:jeff@planetjeff.net)  
Univ. of Pittsburgh

Kerry Handron  
412-578-2580  
[HandronK@CarnegieMuseums.org](mailto:HandronK@CarnegieMuseums.org)  
Carnegie Museum of Natural History

## GIVING VIDEO LETTER

*< Carnegie Museum of Natural History Letterhead >*

*<current date>*

*<name of the student>*

*c/o <student's parents' names>*

*<student's physical or electronic mailing address>*

Dear *<child's name>*,

We hope you enjoyed playing our learning game, the Gates of Horus, here at the museum. Enclosed is a CD containing the documentary video you made about the Virtual Egyptian Temple.

The movie is stored in one or more digital movie formats. To play it, put the CD in your computer and double-click on any of the movie files. The movie should play in a window on your monitor. To hear the sound you will need a pair of computer speakers or headphones. If you have any problems please feel free to contact us. And

Warm Regards,

Jeffrey Jacobson  
412-401-4311  
[jeff@planetjeff.net](mailto:jeff@planetjeff.net)

Kerry Handron  
412-578-2580  
[HandronK@CarnegieMuseums.org](mailto:HandronK@CarnegieMuseums.org)

## RECRUITING FLIER

### **Journey to Ancient Egypt!**

The University of Pittsburgh and the Carnegie Museum of Natural History are looking for middle-school students to be part of a learning experiment. Each student will use Virtual Reality to explore a three-dimensional animation of an ancient Egyptian temple. The experience is structured as a learning game where the student solves conceptual puzzles to open each gate of the temple and unlock the final mystery. To participate, you must be in sixth, seventh or eighth grade at an accredited middle school and you must be either eleven, twelve, thirteen or fourteen years old.

Afterwards, participants will take tests to determine how much they learned from the game, and their general aptitude for spatial reasoning. Students will make a short video giving a guided tour of the temple for their friends or family. The whole process of playing the game and taking the tests is approximately two hours. On test day, they will receive free all-day admission for themselves and their parents to the Carnegie Museum of Natural History in Pittsburgh, where the testing will be held. Students who complete another knowledge test one month later (via the internet) will receive a copy of the video tour they made and a \$5 gift certificate to the Carnegie Museum shop.

We do not guarantee that taking the test will have any direct benefit to you. But maybe you will have some fun, learn a little about ancient Egypt and see some very cool technology.

If you are interested for yourself or your child, please contact Kerry Handron (CMNH) at [HandronK@CarnegieMNH.Org](mailto:HandronK@CarnegieMNH.Org) or Jeffrey Jacobson (PITT) at [goshen@sis.pitt.edu](mailto:goshen@sis.pitt.edu) or call 412-401-4311



Images of the Egyptian temple and it's high priest.



## HINT CARDS

During pilot testing we discovered that *Gates of Horus* (sec 3.3, p98) was too difficult for most students to complete within available time limits. We made for flashcards, one for each area of the Temple with hints on the back of where the more difficult clues are. We did not put any clues there for the pylon area, because the tester will be there to personally coach the student through it. The images here show the front and back of the cards respectively, albeit reduced in size.

<b>Pylon</b>	<b>Courtyard</b>
<b>Hypostyle Hall</b>	<b>Sanctuary</b>

<p><b>Step on the white circle.</b></p> <p><b>There is a clue on the ceiling which is spotlighted.</b></p> <p><b>You can't see all the clues from the doorway.</b></p> <p><b>There is a false clue on the closed doorway to the next room. Please ignore it.</b></p>	<p><b>Step on the white circle.</b></p> <p><b>There is a clue on the front edge of the shrine.</b></p> <p><b>There is a clue on the ground, in front of the shrine.</b></p>
	<p><b>Be sure to step on the white circle to get the introduction speech.</b></p> <p><b>Look up to find a clue.</b></p> <p><b>There is a clue on the ground, near the front of the Courtyard</b></p>

## BIBLIOGRAPHY

- 3Dweb. (2004). *3D Web*, [http://3dweb.netera.ca/about\\_project.html](http://3dweb.netera.ca/about_project.html)
- ACID. (2004). *Digital Songlines*, <http://songlines.interactiondesign.com.au/>
- ActiveWorlds. (2004). *Active Worlds*, <http://www.activeworlds.com/edu/index.asp>
- Addison, A. C. (2000). *Emerging Trends in Virtual Heritage*. *Multimedia*, IEEE, 7(2), 22-25.
- AIA. (2004). *Archaeological Institute of America*, <http://www.archaeological.org>
- Allison, D., Wills, B., Bowman, D., Wineman, J., Hodges, L. (1997). *The Virtual Reality Gorilla Exhibit*. *IEEE Computer Graphics and Applications*, 17(6).
- Andrews, D. C. (2002). *Audience-Specific Online Community Design*. *Communications of the ACM*, 45.
- Antonietti, A., Rasi, C., Imperio E., Sacco, M. (2000). *The Representation of Virtual Reality in Education*. *Education and Information Technologies*, 5(4), 317-327.
- Arabesk. (2004). *Virtual Arabic Museum*, <http://www.museumarabesk.nl/>
- Ardissono, L., Goy, A. (1999). *Tailoring the Interaction With Users in Electronic Shops*. 7th Conference on User Modeling (UM'99), Banff, Canada.
- Arnold, D. (1999). *Temples of the Last Pharaohs*. Oxford, Oxford Press.
- Arthur, E. J., Hancock, P. A. (2001). "Navigation Training in Virtual Environments." *International Journal of Ergonomics*, 5(4): 387-400
- Assis, P. S., Schwabe, D., Barbosa, S. D. J. (2004). *Meta-models for Adaptive Hypermedia Applications and Meta-adaptation*. ED-MEDIA 2004
- Attardi, G., Betro, M., Forte, M., Gori, R., Guidazzoli, A., Imboden, S., Mallegni, F. (1999). *3D facial Reconstruction and Visualization of Ancient Egyptian Mummies Using Spiral CT Data Soft Tissues Reconstruction and Textures Application*. SIGGRAPH 1999
- Avedon, E. M., Sutton-Smith, B. (1972) *The Study of Games*, John Wiley, New York
- Baber, C., Bristow, H., Cheng, S. L., Hedly, A., Kuriyama, Y., Lien, M., Pollard, J., Sorrell, P. (2001). *Augmenting Museums and Art Galleries*. *Human-Computer Interaction*, INTERACT '01
- Balabanovic, B., Shoham, Y. (1997). *Fab: Content-Based, Collaborative Recommendation*. *Communications of the ACM*, 40, 66-72.

- Barfield, W., Weghorst, S. (1993). *The sense of presence within virtual environments: A conceptual framework*. In Human-computer Interaction: Applications and Case Studies (pp. 699-704). Amsterdam: Elsevier
- Barsalou, L. W. (1992). *Cognitive Psychology*. Hillsdale, NJ: Lawrence Erlbaum Associates, Inc. 0-8058-0691-1 (hard) 0-8058-0691-0 (pbk)
- BBC. (2004a). *Virtual Tours (History)*, [http://www.bbc.co.uk/history/multimedia\\_zone/virtual\\_tours/](http://www.bbc.co.uk/history/multimedia_zone/virtual_tours/) **<broken>**
- BBC. (2004b). *World War One Trench*, <http://www.bbc.co.uk/history/3d/trench.shtml> **<broken>**
- Beacham, N. A., Elliott, A.C., Alty, J. L., Al-Sharrah, A. (2002). *Media Combinations and Learning Styles: A Dual Coding Approach*. World Conference on Educational Multimedia, Hypermedia and Telecommunications
- Beacham, R. (2004). *The Theatron Project*, <http://www.theatron.org/>
- Bell, J. T., Folger, S. (1996). *Vicher: A Virtual Reality Based Educational Module for Chemical Reaction Engineering*. Computer Applications in Engineering Education, 4(4).
- Benedikt, A. (1991). *Cyberspace: Some Proposals*. In M. Benedikt (Ed.), *Cyberspace: First Steps* (pp. 255-271). Cambridge, MA: MIT Press. 10262-52177-6
- Bertoletti, A. C. (1999). *SAGRES - A Virtual Museum*. Museums and the Web 1999
- Bertoletti, A. C. (2001). *Providing Personal Assistance in the SAGRES Virtual Museum*. Museums and the Web 2001, Seattle
- Beier, K. P., Et. Al.. (2004). *The Great Pyramid of Khufu*, <http://www-vrl.umich.edu/project/pyramid/index.html>
- Blake, E., Fang, K. C., Feng, F. Y., Wai, K. M. (2003). *Low-Cost Virtual Reality System - PC Driven System* (No. CS03-17-00). Cape Town: Department of Computer Science, University of Cape Town.
- Bloom, B. S. (1956). *Taxonomy of Educational Objectives; Book 1 Cognitive Domain*. New York: Longman Inc. 0-582-28010-9
- Bortner, M. (1965). Progressive Matrices. *The Sixth Mental Measurements Yearbook*. O. K. Buros. Highland Park, NJ, Gryphon Press: 762-465.
- Boulay. (2001). *Modeling Human Teaching Tactics and Strategies for Tutoring Systems*. International Journal of Artificial Intelligence in Education(12), 235-256.
- Bowman, D. A., Hodges L. F., Allison, D., Wineman, J. (1999). *The Educational Value of an Information-Rich Virtual Environment*. Presence Teleoperators and Virtual Environments, 8(3), 317-331.
- Bowman, D. A. (2002). Principles for the Design of Performance-oriented Interaction Techniques. In K. M. Stanney (Ed.), *Handbook of Virtual Environments* (p 277). Mahwah, New Jersey: Lawrence Erlbaum Associates, Inc., Publishers. 0-8058-3270-X
- Bowman, D. A. (2004). *Personal Communication*.

- Bra, P., Aerts, A., Houben, G., Wu, H. (2000). *Making General-Purpose Adaptive Hypermedia Work*. World Conference on the WWW and Internet (WEBNETC)
- Bricken, M. (1990). Virtual Worlds: No Interface to Design. In M. Benedikt (Ed.), *Cyberspace: First Steps* (pp. 363-382). Cambridge, MA: MIT Press. 0-262-02327-X (hb) 0-262-52177-6 (pb)
- Bricken, M., Bryne, C. M. (1992). Summer Students in Virtual Reality: A Pilot Study on Educational Applications of Virtual Reality Technology. In Wexelblat (Ed.), *Virtual Reality, Applications and Explorations*. Cambridge, MA: Academic Press Professional.
- Britannica. (2004). *Encyclopedia Britannica Online*, <http://www.britannica.com>
- Brooks, F. (2004). *Personal communication*.
- Brown, A. L., Champione, J. C. (1994). Guided discovery in a community of learners. In K. McGilly (Ed.), *Classroom Lessons: Integrating Cognitive Theory and Classroom Practice*, Cambridge, MA: MIT Press, MA
- Bruckman, A. (2002a, April). The Future of E-Learning Communities. *Communications of the ACM*, 45, 60-63.
- Bruckman, A. (2002b). *No Magic Bullet: 3D Video Games in Education*. Proceedings of ICLS 2002, Seattle, Washington
- Bruen, C. (2002). *A Development Framework for Re-usable Learning Resources for Different Learning Styles and Requirements*. World Conference on E-Learning in Corp., Govt., Health & Higher Ed. (ELEARN)
- Brusilovs.ky, P. (2001). *Adaptive hypermedia*. User Modeling and User Adapted Interaction, Ten Year Anniversary Issue (Alfred Kobsa, ed.) 11 (1/2), 87-110.
- Brusilovsky, P.J., Henze, nicola, Millan, E. (2002). *Adaptive Systems for Web-Based Education*. WASWBE 2002. 84-699-8192-7
- Brusilovsky, P. (2003a). *Adaptive Navigation Support in Educational Hypermedia: the Role of Student Knowledge Level and the Case for Meta-Adaptation*. British Journal of Educational Technology, 34(4), 487-497.
- Brusilovsky, P., Vassileva, J. (2003b). *Course Sequencing Techniques for Large-scale Web-based Education*. International Journal of Continuing. Engineering Education and Lifelong Learning,, 13(1/2), 75.
- Brusilovsky, P., Peylo, C. (2003c). *Adaptive and Intelligent Web-based Educational Systems*. International Journal of Artificial Intelligence in Education, 13, 156-169.
- Brusilovsky, P. (2004). *Adaptive Navigation Support: From Adaptive Hypermedia to the Adaptive Web and Beyond*. PsychNology Journal, 2(1), 7 - 23.
- Bungert, C. (1998). *Stereoscopic 3D-Quake*, <http://www.stereo3d.com/quake.htm>
- Burgess, e. a. (1999). *Virtual Ancient Egypt Course*, <http://artscool.cfa.cmu.edu:16080/~hemef/egypt/>

- Byrne, C. (1996). *Water on Tap: The Use of Virtual Reality as an Educational Tool*. Unpublished PhD Dissertation, University of Washington, Seattle, Washington. URL: <http://www.hitl.washington.edu/publications/dissertations/Byrne/>
- Campbell, C. T., Stanley, J. C. (1963). *Experimental and Quasi-Experimental Designs for Research*: Houghton Mifflin Company. 0-395-30787-2
- Capasso, G. (2004). *Journey to Pompeii*. Naples: Capware, Ottaviano: Tel.815288505
- Carver, C. A., Howard, R. A., Lane, W. D. (1999a). *Enhancing Student Learning Through Hypermedia Courseware and Incorporation of Student Learning Styles*. IEEE Transactions on Education, 42(1).
- Carver, C. A., Hill, J. M. D., Pooch, U. W. (1999b). *Third Generation Adaptive Hypermedia Systems*. World Conference on the WWW and Internet (WEBNETC)
- Champion, E. (2001). *Travels through the imagination: Future visions of VR & related technologies*. YVR2001. <http://www.arbld.unimelb.edu.au/~erikc/papers/papers.html>
- Champion, E. (2003). *Applying Game Design Theory to Virtual Heritage Environments*. Proceedings of the 1st International Conference on Computer Graphics and Interactive Techniques in Australasia and South East Asia, Melbourne, Australia. 1-58113-578-5 <http://www.arbld.unimelb.edu.au/~erikc/papers/papers.html>
- Champion, E. (2004a). *The Limits of Realism in Architectural Visualization*. 21st Annual Conference of the Society of Architectural Historians Australia and New Zealand, Melbourne, Australia. <http://www.arbld.unimelb.edu.au/~erikc/papers/papers.html>
- Champion, E. (2004b, February 13). *Heritage Role Playing—History as an Interactive Digital Game*. Australian Workshop on Interactive Entertainment, Sydney. <http://www.arbld.unimelb.edu.au/~erikc/papers/papers.html>
- Champion, E. (2004c, 17-19 November). *Hermeneutic Richness from the Inside Out: Evaluation and Virtual Heritage Environments*. VSMM 2004 Hybrid Realities, Digital Partners Ogaki City, Japan. <http://www.arbld.unimelb.edu.au/~erikc/papers/papers.html>
- Chen, Y., Macredie, R. D. (2002). *Cognitive Styles and Hypermedia Navigation: Development of a Learning Model*. Journal of the American Society for Information Science and Technology, 53(1), 3-15.
- Charles F., Lemercier S., Vogt T., Bee N., Mancini M., Urbain J., Price M., André E., Pélachaud C., and Cavazza M., Demo paper for Virtual Storytelling 2007 (ICVS 2007), France, December 5-7, 2007. [http://ive.scm.tees.ac.uk/content/1191631935/icvs07\\_CharlesCavazza\\_Demo.pdf](http://ive.scm.tees.ac.uk/content/1191631935/icvs07_CharlesCavazza_Demo.pdf)
- Cheverst, K., Davies, N., Mitchell, K., Friday, A., Efstratiou, C. (2000). *Developing a Context-aware Electronic Tourist Guide: Some Issues and Experiences*. CHI 2000 / Chi Letters
- Chicago, O. I. (1930-1969). Medinet Habu. Chicago, The University of Chicago Oriental Institute Publications.
- Chin, D. N. (1989). KNOBE: Modeling What the User Knows in UC. In A. Kobsa and W. Wahlster (eds.) *User Models in Dialog Systems*, (pp. 74-107): Springer-Verlag

- Chittaro, L., Ranon, R., Leronutti. (2003, November 4). *Navigating 3D Worlds by Following Virtual Guides: Helping both Users and Developers of 3D Web Sites*. HCITALY 2003, Torino, Italy
- Chittaro, L., Leronutti, L., Ranon, R. (2004). *Navigating 3D Virtual Environments by Following Embodied Agents: a Proposal and its Informal Evaluation on a Virtual Museum Application*. *PsychNology Journal*, 2(1), 24 - 42.
- Cho, Y., Moher, T., Johnson, A. (2003). *Scaffolding Children's Scientific Data Collection in a Virtual Field*. VSMM 2003
- Chromium. (2004). *Chromium* <http://chromium.sourceforge.net/>
- Clarebout, G., Elen, J., Johnson, W. (2002). *Animated pedagogical agents: Where do we stand?* World Conference on Educational Multimedia, Hypermedia and Telecommunications.
- Clark, D. (1999). *Learning Domains or Bloom's Taxonomy*, <http://www.nwlink.com/~donclark/hrd/bloom.html>
- Cobb, S., Helen, N., Crosier, J., Wilson, J. R. (2002). Development and Evaluation of Virtual Environments for Education. In K. M. Stanney (Ed.), *Handbook of Virtual Environments; Design, Implementation, and Applications*. Mahwah, NJ & London: Lawrence Erlbaum Associates
- Cox, R., Donnell, M. O., Oberlander, J. (1999). *Dynamic versus static hypermedia in museum education: an evaluation of ILEX, the intelligent labeling explorer*. *Artificial Intelligence in Education*, Le Mans
- Craig, S., Gholson, B. (2002). *Does an agent matter? The Effects of Animated Pedagogical Agents on Multimedia Environments*. World Conference on Educational Multimedia, Hypermedia and Telecommunications (ED-MEDIA)
- Cristea, A., Garzotto, F. (2004). *Designing patterns for adaptive or adaptable educational hypermedia: a taxonomy*. World Conference on Educational Multimedia, Hypermedia and Telecommunications (ED-MEDIA)
- Cruz-Neira, C., Sandin, D., DeFanti, T. A. (1993). *Surround-Screen Projection-Based Virtual Reality: The Design and Implementation of the CAVE*. SIGGRAPH '93
- CVRLab. (2004). *Cultural VR Lab*, <http://www.cvrlab.org/>
- Dalgarno, B., Hedberg, J. (2001a). *3D Learning Environments in Tertiary Education*. ASCILITE, Melbourne. <http://www.ascilite.org.au/conferences/melbourne01/pdf/papers/dalgarnob.pdf>
- Dalgarno, B. (2001b). *Interpretations of Constructivism and Consequences for Computer Assisted Learning*. *British Journal of Educational Technology*, 32(2).
- Dalgarno, B., Hedberg, J., Harper, B. (2002a). *The Contribution of 3D Environments to Conceptual Understanding*. European Conference on AI in Education
- Dalgarno, B. (2002b). *The Potential of 3D Virtual Learning Environments: A Constructivist Analysis*. *E-Journal of Instructional Science and Technology*, 5(2).
- Danielson, R. L. (1997). *Work in Progress: Learning Styles, Media Preferences, and Adaptive Education*. Adaptive Systems and User Modeling on the World Wide Web, Chia Laguna, Sardinia. [http://www.contrib.andrew.cmu.edu/~plb/UM97\\_workshop/Danielson.html](http://www.contrib.andrew.cmu.edu/~plb/UM97_workshop/Danielson.html)

- Darken, R. P., Bernatovich, D., Lawson, J., and Peterson, B. (1999b). *Quantitative Measures of Presence in Virtual Environments: The Roles of Attention and Spatial Comprehension*. *Cyberpsychology and Behavior*, 2(4), 337-347.
- Darken, R. P., Peterson, B. (2001). *Spatial Orientation, Wayfinding, and Representation*. In K. M. Stanney, Kennedy, R. S. (Ed.), *Handbook of Virtual Environment Technology*
- Dede, C., Salzman, M. C., Loftin, R. B. (1996). *ScienceSpace: Virtual realities for learning complex and abstract scientific concepts*. IEEE Virtual Reality Annual International Symposium, New York
- Dede, C., Salzman, M. C., Loftin, R. B., Sprague, D. (1999). *Multisensory Immersion as a Modeling Environment for Learning Complex Scientific Concepts*. In *Computer Modeling and Simulation in Science Education*: Springer-Verlag
- Dede, C. (2004). *Multi-User Virtual Environment Experiential Simulator*, <http://muve.gse.harvard.edu/muvees2003/index.html>
- DeLeon, V. J., Berry, R., Jr. (2000). *Bringing VR to the desktop: are you game?* *Multimedia, IEEE*, 7(2), 68-72.
- DeLeon, V. J. (1999). *VRND: Notre-Dame Cathedral: A Globally Accessible Multi-User Real-Time Virtual Reconstruction*. *Proceedings, Virtual Systems and Multimedia (VSMM) 1999*.
- Driver, R. (1995). *Constructivist Approaches to Science Teaching*. In Steffe, L. P., Gale, J. E. (Ed.), *Constructivism in Education*. Hillsdale, NJ: Lawrence Erlbaum Assoc.
- Dudley. (2004). *Dudley Castle 'Virtual Tours'*, <http://www.imint.freeseerve.co.uk/historic.htm>
- Duncan, M., Kelley, M., Jacobson, J. (2006) High School Graduate Refines Gyromouse Interface For Virtual Reality; Preteens Play Crucial Role. *Computer Graphics Quarterly*, Vol. 40, No. 2, ACM SIGGRAPH (publisher), August 2006.
- Duran, Z., Dogru, A. G., Toz, G. (2004). *Web-Based Multimedia GIS for Historical Sites*. 20th ISPRS Congress, Istanbul, Turkey
- Durlach, N., Darken, R. P., Allen, G., Loomis, J., Templeman, J. (2000). *Virtual Environments and the Enhancement of Spatial Behavior: Toward a Comprehensive Research Agenda*. *Presence: Teleoperators and Virtual Environments*, 9(6): 593 - 615.
- DWI. (2004). *Digital Worlds Institute*, <http://www.digitalworlds.ufl.edu/>
- Economou, D., Mitchell, W., Pettifer, S., Cook, J., Marsh, J. (2001). *User Centered Virtual Actor Technology*. *Conference of Virtual Reality, Archeology, and Cultural Heritage*. 1-58113-447-92001
- Ellis, S. R. E. (1991). *Pictorial Communication in Virtual and Real Environments* (2nd ed.). London: Taylor and Francis
- Elumens. (2001). *Elumens Corporation Announces SPI-API For Multigen-Paradigm Vega Customers*, [http://www.multigen.com/news/pr/0812\\_01\\_2.shtml](http://www.multigen.com/news/pr/0812_01_2.shtml)
- Eluminati. (2008). *Eluminati* <http://www.elumenati.com>.
- EpicGames. (2004). *Unreal Tournament* <http://www.unrealtournament.com>.



- Eurographics. (2004). *European Association for Computer Graphics*, <http://www.eg.org/>
- Fallman, D. (1999, February 18-19). *VR in Education: An Introduction to Multisensory Constructivist Learning Environments*. Conference on University Pedagogy, Umea University, Sweden. [http://daniel.fallman.org/resources/papers/Fallman\\_VRIE.pdf](http://daniel.fallman.org/resources/papers/Fallman_VRIE.pdf)
- Fong, T., Nourbakhsh, I., Dautenhahn, K. (2003). *A Survey of Socially Interactive Robots*. *Robotics and Autonomous Systems*(42), 143-166.
- Forman, E. A. (1989). *The role of peer interaction in the social construction of mathematical knowledge*. *International Journal of Educational Research*(13), 55-70.
- Fleiss, J. L., Levin, B., Cho, M.(1981) *Statistical Methods for Rates and Proportions*. ISBN: 0-471-52629-0
- Fleiss, J. L., Nee, J. C. M., Landis, J. R. (1979) *Large sample variance of kappa in the case of different sets of raters*. *Psychological Bulliten*.
- Freudenberg, B., Masuch, M., Rober, N., Strothotte, T. (2001). *The Computer-Visualistik-Raum: Veritable and Inexpensive Presentation of a Virtual Reconstruction*. VAST2001: Virtual Reality, Archeology, and Cultural Heritage
- Frischer, B., Favro, D., Liverani, P., De Blaauw, S., Abernathy, D. (2000). *Virtual Reality and Ancient Rome: The UCLA Cultural VR Lab's Santa Maria Maggiore Project*. In J. A. Barcelo, Forte, M., Sanders, D. H. (Ed.), *Virtual Reality in Archeology, British Archaeological Reports, International Series S 843* (pp. 155-162). Oxford: ArchoPress
- Frischer. (2003). *Mission and Recent Projects of the UCLA Cultural Virtual Reality Laboratory*. *Virtual Retrospect 2003 or Virtual Concept 2003*(November), 5-7 <http://www.cvrilab.org/>.
- Furness, T. A., Winn, W., Yu, R. (1997). *The Impact of Three Dimensional Immersive Virtual Environments on Modern Pedagogy*. <http://www.hitl.washington.edu/publications/r-97-32/>.
- Gabrielli, S., Rogers, Y., Saife, M. (2000). *Young Children's Spatial Representations Developed Through Exploration of a Desktop Virtual Reality Scene*. *Education and Information Technologies* 5(4): 251-262.
- Gagne, R. M. (1987). *Instructional technology: Foundations*. Hillsdale, NJ.um: Lawrence Erlbaum Associates
- Gardner, H. (1983). *Frames of Mind*: Basic Books. 0-465-02508-0 0-465-02509-9 0-465-02510-2
- Gardner, H. (1999). *Intelligence Reframed*. New York: Basic Books. 0-465-02611-7
- Garlatti, S., Iksal, S., Kervella, P. (1999). *Adaptive On-Line Information System by Means of a Task Model and Spatial Views*. 2nd Workshop on Adaptive Systems and User Modeling on the WWW
- Garzotto, F., Cristea, A. (2004). *ADAPT Major Design Dimensions for Educational Adaptive Hypermedia*. World Conference on Educational Multimedia, Hypermedia and Telecommunications (ED-MEDIA)
- Gauthier, J. M. (2003). *Virtual Archeology at Aphrodisias*, <http://www.tinkering.net/aphro.htm>
- Gibson, J. J. (1979). *The Ecological Approach to Visual Perception*. Boston: Houghton Mifflin

- Gibson, W. (1984). *Neuromancer*. N.Y., N.Y.: Penguin Putnam, Inc. 0-441-56959-5
- Goerger, S., Darken, R., Boyd, M., Gagnon, T., Liles, S., Sullivan, J., & Lawson, J. (1998). Spatial Knowledge Acquisition from Maps and Virtual Environments in Complex Architectural Spaces, Proceedings of the 16th Applied Behavioral Sciences Symposium, U.S. Air Force Academy, Colorado Springs, CO.
- Grajetzki, W., Quirke, S., Shide, N. (2003). *Digital Egypt for Universities*, <http://www.digitalegypt.ucl.ac.uk/Welcome.html>
- Gregory, R. J. (1999). *Foundations of Intellectual Assessment*. Needham Heights, MA, Allyn & Bacon.
- Hafner, U., Matthias, B., Magg, R. (2000). Wireless Interaction in Cost-Effective Display Environments. Immersive Projection Technology Workshop (IPT2000).
- Hall, R. (1998), "R Significance/Probability Table," Psychology World (publisher's website) <http://web.umn.edu/~psyworld/rcalculator.htm#1>
- Han, M., Kanade, T. (2000, December). *Creating 3D Models with Uncalibrated Cameras*. IEEE Computer Society Workshop on the Application of Computer Vision (WACV2000)
- Harris, L. J., M., Zikovitz, D.C. (1998). *Vestibular Cues and Virtual Environments*. Virtual Reality Annual International Symposium, 1998
- Harris, L. J., M., Zikovitz, D.C. (1999, 13-17 March). *Vestibular cues and virtual environments: choosing the magnitude of the vestibular cue*. Virtual Reality, 1999
- Hay, K., Crozier, J., Barnett, M., Allison, D., Bashaw, M., Hoos, B., & Perkins, L. (2000). Virtual Gorilla Modeling Project: Middle School Students Constructing Virtual Models for Learning. In Fishman, B. J., O'Connor S. F. (Ed.), *International Conference of the Learning Sciences* (pp. 212-214): Mahwah, NJ: Erlbaum. <http://www.umich.edu/~icls/>
- Heim, M. (1993). *The Metaphysics of Virtual Reality*. Oxford: Oxford University Press. 0-195-09258-9
- Herpers, R., Hetmann, F., Hau, A., Heiden, W. (2005). Immersion Square - A Mobile Platform for Immersive Visualizations. *Proc. Virtual Environment on a PC Cluster Workshop, Protvino, Russia, 2002*. <http://viswiz.gmd.de/VEonPC/2002/proceedings/03-1.pdf>
- Hoffman, H.G., Prothero, J., Wells, M. and Groen, J. (1998). Virtual Chess: Meaning enhances users' sense of presence in virtual environments. *International Journal of Human-Computer Interaction*, 10(3), 251-263.
- Hollan, J., Hutchins, E., Kirsh, D. (2000). *Distributed Cognition: Toward a new Foundation for Human-Computer Interaction Research*. 2000 ACM Transactions on Human-Computer Interaction, 7(2), 174-196.
- Holloway, D. R. (2000). Native American Virtual Reality Archeology: An Architect's Perspective. In *Virtual Reality in Archeology*. London: Archo Press
- Honpaisanwiwat, C. (2002). *The Influence of Animated Character on Comprehension and Attention Performance in Multimedia Presentation*. Unpublished Doctoral Dissertation, Dept. of Information Science and Telecommunications, University of Pittsburgh.

- Houghton-Mifflin. (2000). *The American Heritage® Dictionary of the English Language*, Fourth Edition, Boston
- Howarth, P. A. (1998). *Oculomotor Changes Within Virtual Environments*. *Applied Ergonomics*, 30, 59-67.
- Hullfish, K. C. (1996). *Virtual Reality Monitoring*. Unpublished Master's Thesis, University of Washington, <http://www.hitl.washington.edu/publications/hullfish/>.
- Hutchins, E. (1995a). *Cognition in the Wild*: MIT Press. 0-262-58146-9
- Hutchins, E. (1995b). *How a Cockpit Remembers Its Speeds*. *Cognitive Science*, 19, 265-288.
- IAA. (2004). *The Institute of Archeology and Antiquity*, [http://www.arch-ant.bham.ac.uk/Computing/HP\\_VISTA/HPindex.htm](http://www.arch-ant.bham.ac.uk/Computing/HP_VISTA/HPindex.htm)
- Id\_Software. (2004). *Doom III* <http://www.doom3.com/>.
- Igarashi, T., Matsuoka, S., Tanaka, H. (1999). *Teddy: a sketching interface for 3D freeform design*. International Conference on Computer Graphics and Interactive Techniques. 0-201-48560-5
- iGrid. (2000). *Cultural Heritage in Virtual Reality*, <http://www.startap.net/startap/igrd2000/cultHeritVR00.html>
- Jaccard, James and Choi K. Wan (1996). LISREL approaches to interaction effects in multiple regression. Thousand Oaks, CA: Sage Publications.
- Jackson, R. L., Winn, W. (1999, Dec. 12-15). *Collaboration and Learning in Immersive Virtual Environments*. Proceedings of the Computer Support for Collaborative Learning (CSCL) 1999 Conference, Stanford University, Palo Alto, California
- Jackson, R. L. (2000). *Collaboration and Learning Within Tele-Immersive Virtual Environments*, unpublished doctoral dissertation, University of Washington, Seattle, Washington.
- Jacobson, J., Vadnal, J. (1998). *Learning in a Highly Interactive, Low-Resolution Virtual Environment: The Tomb of Lady Hao*. IEEE International Conference on Systems, Man, and Cybernetics. <http://planetjeff.net/IndexDownloads/hao-smc98.pdf>
- Jacobson, J., Redfern, M. S., Furman, J. M., Whiney, L. W., Sparto, P. J., Wilson, J. B., Hodges, L. F. (2001, November). *Balance NAVE; A Virtual Reality Facility for Research and Rehabilitation of Balance Disorders*. Virtual Reality Software and Technology Meeting, Banff, Canada. <http://planetjeff.net/IndexDownloads/VRST-2001.pdf>
- Jacobson, J., Hwang, Z. (2002a, January). Unreal Tournament for Immersive Interactive Theater. *Communications of the ACM*, 45, 39-42.
- Jacobson, J. (2004a). *Planet Jeff*, <http://planetjeff.net>
- Jacobson, J. (2004b). *CaveUT*, <http://planetjeff.net/ut/CaveUT.html>
- Jacobson, J., et al. (2004c). *The Pompeii Project*, <http://artscool.cfa.cmu.edu/~hemef/pompeii> or <http://publicvr.org/#Pompeii>

- Jacobson, J., Holden, L. (2005e). The Virtual Egyptian Temple. *World Conference on Educational Media, Hypermedia & Telecommunications (ED-MEDIA)*, Montreal, Canada.
- Jacobson, J., Lewis, L. (2005i). Game Engine Virtual Reality With CaveUT. *IEEE Computer*, 38, 79-82.
- Jiman, J. (2002). *Virtual Reality: The Future of Animated Virtual Instructor, The Technology and Its Emergence to a Productive E-Learning Environment*. World Conference on E-Learning in Corp., Govt., Health., & Higher Ed., 2002
- Johansson, P. (2002). User Modeling in Dialog Systems.  
[http://www.ida.liu.se/~ponjo/downloads/papers/johansson\\_sar2002.pdf](http://www.ida.liu.se/~ponjo/downloads/papers/johansson_sar2002.pdf)
- Johns, C. (2002). The Spatial Learning Method: *Facilitation of Learning Through the Use of Cognitive Mapping in Virtual Environments*. Computer Science. Cape Town, University of Cape Town.
- Johnson, A., Roussos, M., Leigh, J., Vasilakis, C., Barnes, C., Moher, T. (1998a). *The NICE Project: Learning Together in a Virtual World*. VRAIS '98.  
<http://www.evl.uic.edu/aej/vrais98/vrais98.2.html>
- Johnson, A., Leigh, J., Costigan, J. (1998b). *Multiway Tele-Immersion at Supercomputing 97; Or, Why We Used \$6,000,000 Worth of VR Equipment to do the Hokey Pokey*. *IEEE Computer Graphics and Applications*, 18(4), 2-5.
- Johnson, A., Moher, T., Ohlsson, S., Leigh, J. (1999a, March). *Exploring Multiple Representations in Elementary School Science Education*. Virtual Reality 2001, Yokohama, Japan
- Johnson, A., Moher, T., Cho, Y.J., Lin, Y.J., Haas, D., Kim, J. (2002). *Augmenting elementary school education with VR*. *Computer Graphics and Applications*, IEEE, 22(3).
- Johnson, A., Moher, T., Cho, Y.J., Edelson, D., Russell. (2003). *'Field' Work. SIGGRAPH 2003 Educators Program*, San Diego, CA
- Jonassen, D. H. (1995). *Constructivism and computer-mediated communication in distance education*. *American Journal of Distance Education*, 9(2), 7-26.
- Jonassen, D. H., Land, S. M. (2000a). *Theoretical Foundations of Learning Environments*. Mahwah, New Jersey: Lawrence Erlbaum Associates. 0-8058-3215-7 hardback, 0-8058-3216-5 paperback
- Jonassen, D. H., Land, S. M. (2000b). Preface. In *Theoretical Foundations of Learning Environments*. Mahwah, New Jersey. 0-8058-3215-7 hardback, 0-8058-3216-5 paperback
- Jonassen, D. H. (2000c). Revisiting Activity Theory as a Framework for Designing Student-Centered Learning Environments. In *Theoretical Foundations of Learning Environments*. Mahwah, New Jersey. 0-8058-3215-7 hardback, 0-8058-3216-5 paperback
- Jung, T., Gross, M. D., Yi-Luen Do, E. (2002). *Annotating and sketching on 3D web models*. International Conference on Intelligent User Interfaces, San Francisco, California, USA. 1-58113-459-2
- Kameas, A., Pintelas, P., Mikropoulos, T. A., Katsikis, A., Emvalotis, A. (2000). *EIKON: Teaching a high-school technology course with the aid of virtual reality*. *Education and Information Technologies*, 5(4), 305-315.

- Kanade, T., Rander, P., Narayanan, P. J. (1997). *Virtualized Reality: Constructing Virtual Worlds from Real Scenes*. IEEE Multimedia.
- Karabiber, Z. (2002). *The Conservation of Acoustical Heritage*. First International Workshop on 3D Virtual Heritage, Geneva, Switzerland
- Kennedy, R. S., Fowl. (1992). *Use of a motion sickness history questionnaire for prediction of simulator sickness*. Aviation, Space, & Environmental Medicine, 63(7), 588-593.
- Kennedy, R. S. L. (1995, 11-15 March 1995). *Implications of balance disturbances following exposure to virtual reality systems*. Virtual Reality Annual International Symposium, 1995
- Kim, K. (1999). *Effects of Problem Solving Style on Information-Seeking Behavior*. ED-MEDIA
- Kim, M., & Ryu, J. (2003). *Meta-Analysis of the Effectiveness of Pedagogical Agent*. World Conference on Educational Multimedia, Hypermedia and Telecommunications.
- Kim, Y., Baylor, A., & Reed, G. (2003). *The Impact of Image and Voice with Pedagogical Agents*. World Conference on E-Learning in Corp., Govt., Health., & Higher Ed.
- King, J. E. (2007) <http://www.ccitonline.org/jking/homepage/kappa.xls>
- Kirriemuir, J., McFarlane, A. (2004). Literature Review in Games and Learning, NESTA FUTURELAB. [http://www.nestafuturelab.org/research/reviews/08\\_01.htm](http://www.nestafuturelab.org/research/reviews/08_01.htm)
- Koepsell, D. R. (2000). *The Ontology of Cyberspace: Philosophy, Law, and the Future of Intellectual Property*. Peru, Illinois: Open Court Publishing
- Koh, G., von Wiengand, T. E., Garnett, R. L., Durlach, N. I. (1999). "Use of Virtual Environments for Acquiring Configurational Knowledge About Specific Real-World Spaces." *Presence* 8(6): 632-656.
- Kolasinski, E. M. (1995). *Simulator Sickness in Virtual Environments; Technical Report 1027: Simulator Systems Research Unit, Training Systems Research Division, U.S. Army Research Institute for the Behavioral and Social Sciences*.
- Kufu. (2004). *The Great Pyramid of Khufu*, <http://www-vrl.umich.edu/project/pyramid/index.html>
- Kuno, S., Kawakita, T., Kawakami, O., Miyake, Y., Wantanabe, S. (1999). *Postural Adjustment Response to Depth Direction Moving Patterns Produced by Virtual Reality Graphics*. Japanese Journal of Psychology, 49, 417-424.
- Kwon, Y. M., Hwang, J. E., Lee, T. S., Jeong, M., Suhl, J. K., Ryu, S. W. (2003). *Toward the Synchronized Experiences between Real and Virtual Museum*. APAN, Fukuoka
- Land, S. M., Hannafin, M. J. (2000). Student-Centered Learning Environments. In *Theoretical Foundations of Learning Environments*. Mahwah, New Jersey. 0-8058-3215-7 hardback, 0-8058-3216-5 paperback
- Lange, K. A. H. (1961). *Egypt: Architecture, Sculpture and Painting in Three Thousand Years*. London: Phaidon Press, London
- Larkin-Hein, T., Budny, D. D. (2001). Research on Learning Style: Applications in the Physics and Engineering Classrooms. *IEEE Transactions on Education*, 44(3).

- LearningSites. (2004). *Learning Sites Inc.*, [http://www.learningsites.com/Frame\\_layout01.htm](http://www.learningsites.com/Frame_layout01.htm)
- Ledermann, F., Schmalstieg, D. (2003). *Presenting an Archaeological Site in the Virtual Showcase*. 4th International Symposium on Virtual Reality, Archeology and Intelligent Cultural Heritage, VAST 2003
- Lehner. (2003). *Virtual Giza*, <http://oi.uchicago.edu/OI/PROJ/GIZ/Giza.html>
- Lessiter, J., Freeman, J., Keogh, E., Davidoff, J. (2001). *A Cross-Media Presence Questionnaire: The ITC-Sense of Presence Inventory*. *Presence Teleoperators and Virtual Environments*, 10(3).
- Levy, A. Y., Weld, D. S. (2000). *Intelligent Internet Systems*. *Artificial Intelligence*, 118, 1-14.
- Levy, R. M., Dawson, P. C., Arnold, C. (2004). *Reconstructing traditional Inuit house forms using Three-dimensional interactive computer modeling*. *Visual Studies*, 19(1).
- Lewis, M., Jacobson, J. (2002). *Game Engines In Scientific Research*. *Communications of the ACM*, 45, 27-31.
- Lin, J. J. W., Duh, B. L., Parker, D. E., Abi-Rached, H., Furness, T. A. (2002). *Effects of Field of View on Presence, Enjoyment, Memory, and Simulator Sickness in a Virtual Environment*. *IEEE Virtual Reality Conference 2002*. 0-7695-1492-8
- Loftin, R. B., Engleberg, M., Benedetti, R. (1993). *Virtual Controls in Interactive Environments: A Virtual Physics Laboratory*. *Society for Information Display International Symposium Digest of Technical Papers*.
- Loftin, R. B. (2004). Personal communication at the conference, "Virtual Reality 2004".
- Maloney, J. (1997). *Fly Me to the Moon: A Survey of American Historical and Contemporary Simulation Entertainments*. *Presence: Teleoperators and Virtual Environments*, 6(5), 565 - 580.
- Mammar, H. H., Bernard, F. T. (2002). *Cognitive User Profiles for Adapting Multimedia Interfaces*. *World Conference on Educational Multimedia, Hypermedia and Telecommunications 2002*
- Manouselis, N., Sampson, D. (2002). *Dynamic Educational E-Content Selection using Multiple Criteria Analysis in Web-based Personalized Learning Environments*. *The 14th World Conference on Educational Multimedia, Hypermedia and Telecommunications (ED-MEDIA 2002)*, Denver, Colorado, USA.  
[http://www.ask.itl.gr/Uploads/Files/Publications/Gr\\_Pubs/ManSamEDMEDIA02\\_draft.pdf](http://www.ask.itl.gr/Uploads/Files/Publications/Gr_Pubs/ManSamEDMEDIA02_draft.pdf)
- Mayer, R. E. (1987). *Educational Psychology; A Cognitive Approach*. Boston: Little, Brown and Company. 0-316-55151-1
- Mayer, R. E. (2001c). *Multimedia Learning*: Cambridge University Press. 0-521-7839-2, 0-521-7839-1
- Megazina. (2002). *Pompeii: An adventure during the last days of Pompeii*, <http://hem.passagen.se/zinana/pomprot/sidor/uk2-1.html>
- Michell, W. L., Economou, D. (2000). *The Internet and Virtual Environments in Heritage Education: More Than Just a Technical Problem*. In Barcelo, J. A., Forte, M., Sanders, D. H. (Ed.), *Virtual Reality in Archeology* (pp. 149-154). 1-84171-047-4

- Milosavljevic, M., Dale, R., Green, S. J., Paris, C., Williams, S. (1998). *Virtual Museums on the Information Superhighway: Prospects and Potholes*. Annual Conference of the International Committee for Documentation of the International Council of Museums, CIDOC'98
- MIRALab. (2004). *MIRALab*, Virtual Life in Pompeii, <http://www.miralab.unige.ch/>
- Moher, T., Johnson, A. (1999). *Bridging Strategies for VR-Based Learning*. Computer Human Interaction (CHI), Pittsburgh, Pennsylvania, USA
- Moher, T. (2004). Personal Communication.
- Moltenbrey, K. (2001, September). Preserving the Past. *Computer Graphics World*.
- Moreno, R., Mayer, R. E., Lester, J. C. (2000a). *Life-Like Pedagogical Agents in Constructivist Multimedia Environments: Cognitive Consequences of their Interaction*. ED-MEDIA 2000
- Moreno, R., Mayer, R. E. (2000b). *Meaningful Design for Meaningful Learning: Applying Cognitive Theory to Multimedia Explanations*. ED-MEDIA 2000
- Moreno, R., Mayer, R. E., Spires, H. A., Lester, J. C. (2001a). *The Case for Social Agency in Computer-Based Teaching: Do Students Learn More Deeply When They Interact With Animated Pedagogical Agents?* *Cognition and Instruction*, 19(2), 177-213.
- Moreno, R., Mayer, R. E. (2001b). *Virtual Reality and Learning: Cognitive and Motivational Effects of Students' Sense of Presence*. WebNet 2001, Charlottesville, VA
- Moreno, R. (2002b). *Pedagogical Agents in Virtual Reality Environments: Do Multimedia Principles Still Apply?* World Conference on Educational Multimedia, Hypermedia and Telecommunications (ED-MEDIA), Charlottesville, VA
- Hughes, C. E., Moshell, J. M., Reed, D. Chase, D. Z., Chase, A. F. (2001). The Caracol Time Travel Project. *Journal of Visual Computer Animation*, 12, 203-214.
- Moshell, J. M., and Hughes, Charles E. (2002). Virtual Environments as a Tool for Academic Learning. In K. M. Stanney (Ed.), *Handbook of Virtual Environments; Design, Implementation, and Applications* (pp. 893-910). Mahwah, NJ & London: Lawrence Erlbaum Associates
- Multigen. (2004). *Multigen*, <http://www.multigen.com/>
- Nord, B., Colbengtson, T. C. (2003). *Virtual Vouni, The Museum of the Future*. VR for Public Consumption (Workshop at VR2003), Chicago
- Norman, D. A. (1988). *The Design of Everyday Things*. New York: Basic Books. 0-465-06710-7
- Not, E., Zancanaro, M. (1998a, June 20-24, 1998). *Content Adaptation for Audio-based Hypertexts in Physical Environments*. 2nd Workshop on Adaptive Hypertext and Hypermedia, HYPERTEXT'98, Pittsburgh
- Not, E., Petrelli, D., Sarini, M., Stock, O., Strapparava, C., Zancanaro, M. (1998b). *Hypernavigation in the physical space: adapting presentations to the user and to the situational context (Technical Note)*. *The New Review of Hypermedia and Multimedia*, 4, 33-34.
- Nykanen, O., Ala-Rantala, M. (1998). *A Design for a Hypermedia-based Learning Environment*. *Education and Information Technologies*(3, 1998), 277-290.

- Oberlander, J., O'Donnel, M., Mellish, C., Knott, A. (1998). *Conversation in the museum: experiments in dynamic hypermedia with the intelligent labeling explorer*. The New Review of Hypermedia and Multimedia, 4, 11 - 32.
- Octaga. (2004) *Octaga*. [www.octaga.com](http://www.octaga.com)
- Oliverio, J., Sompura, R. (2003). *Extending Virtual Heritage Beyond the Local Site: Creating An International Digital Network*. Virtual Systems and Multimedia, Montreal, Canada
- Olwal, A. (2002). Unit – A Modular Framework for Interaction Technique Design, Development and Implementation. Master's Thesis: Dept. of Numerical Analysis and Computer Science at the Royal Institute of Technology (KTH), Stockholm, Sweden, executed in the Computer Graphics and User Interfaces Laboratory at the Dept. of Computer Science at Columbia University (CU), New York, USA. <http://www.nada.kth.se/~alx/text/thesis.pdf>
- OnlineArchaeology. (2004). *Online Archeology*, <http://www.online-archaeology.co.uk/>
- Oppermann, R., Specht, M. (1999). *A Nomadic Information System for Adaptive Exhibition Guidance*. International Cultural Heritage Informatics (CHIM), Washington, DC, USA
- Osberg, K. M. (1997a). *Constructivism in Practice: The Case for Meaning-Making in the Virtual World*. Unpublished doctoral dissertation, University of Washington, Seattle, Washington.
- OsmosisInc. (2000). Virtual Olympia, [http://www.osmosis.com.au/visualize/olympia\\_01.htm](http://www.osmosis.com.au/visualize/olympia_01.htm)
- OsmosisInc. (2004). Virtual Ayutthaya, [http://www.osmosis.com.au/animate/ayutthaya\\_01.htm](http://www.osmosis.com.au/animate/ayutthaya_01.htm)
- Owen, N., Leadbetter, A. G., Yardley, L. (1998). Relationship Between Postural Control and Motion Sickness in Healthy Subjects. *Brain Research Bulletin*, 47(5), 471-474.
- Örnberg, T. (2003). *Why Computers? Constructivist Language Learning on the Internet*. Unpublished master's thesis, Umeå University, <http://www2.humlab.umu.se/therese/exjobb.pdf>.
- Pair, J., Gotz, D., Wilson, J., Hodges, L., Jensen, C., Flores, J. Arias, J. (2000). *NAVE: Low Cost Spatially Immersive Display System*, <http://mysite.verizon.net/jarrell.pair/NAVE/navejarrell.htm>
- Papagiannakis, G., Foni, A., Magnenat-Thalmann, N. (2003). *Real-Time recreated ceremonies in VR reconstituted cultural heritage sites*. CIPA 19th International Symposium
- Papagiannakis, S., S., Ponder, M., Arevalo, M., Magnenat-Thalmann, N. (2004a, 15-16 March 2004). *Real-Time Virtual Humans in AR Sites*, London, UK
- Papagiannakis, G., Schertenleib, S., O'Kennedy, B., Poizat, M. (2004b). Mixing Virtual and Real scenes in the site of ancient Pompeii. *Journal of Computer Animation and Virtual Worlds*, 16(1), 11-24.
- Papiaoannou, G., Gaitatzes, A., Christopoulos, D. (2003). *Enhancing Virtual Reality Walkthroughs of Archaeological Sites*. 4th International Symposium on Virtual Reality, Archaeology and Intelligent Cultural Heritage
- Pape, D., Anstey, J., Carter, B., Leigh, J., Roussou, M., Portlock, T. (2000). *Virtual Heritage at iGrid 2000*. iGrid 2000
- Pape, D., Anstey, J., Dawe G., (2002). *A Low-Cost Projection Based Virtual Reality Display*. SPIE Electronic Imaging: Science and Technology 2002, San Jose.



- Patel, H., et al. (2001). VIEW of the future, Information Society Technologies (IST), Technical Report: IST-2000-26089 [www.view.iao.fraunhofer.de/pdf/D3\\_2.pdf](http://www.view.iao.fraunhofer.de/pdf/D3_2.pdf)
- Park, C., Ko, H., Kim, T. (2003). *NAVER: Networked and Augmented Virtual Environment Architecture; Design and Implementation of VR Framework for Gyeongju VR Theater*. Computers & Graphics, 223–230.
- Pausch, R., Proffitt, D., Williams, G. (1997). *Quantifying Immersion in Virtual Reality*. ACM SIGGRAPH 1997
- Petrelli, D., De Angeli, A., Convertino, G. (1999). *A User-Centered Approach to User Modeling*. Proceedings of the Seventh International Conference of User Modeling.
- Picard, R. W. (2000). *Affective Computing*. Boston, MA: MIT Press. 0-262-66115-2
- Piekarski, W., Thomas, B. (2002). *ARQuake: The Outdoor Augmented Reality Gaming System*. Communications of the ACM, 45, 36-38.
- Pivec, M. (2003b, December). *UniGame: Game-based Learning in Universities and Lifelong Learning*. Internationale Konferenz für technologisch gestützte Aus- und Weiterbildung
- Pizzi, D. and Cavazza, M., AAAI Fall Symposium on Intelligent Narrative Technologies, Arlington, Virginia, November 2007. <http://ive.scm.tees.ac.uk/content/uploads/PDF/FS06PizziA.pdf>
- Prothero, J. D., Draper, M. H., Furness, T. A., Parker, D. E., Wells, M., J. (1999). *The Use of an Independent Visual Background to Reduce Simulator Side-Effects*. Aviation, Space, and Environmental Medicine, 70(3).
- Psokta, J. (1996). *Factors Affecting the Location of Virtual Egocenters; From The Renaissance to Cyberspace*. (No. ATTN: PERI-IIC, 5001 Eisenhower Ave. Alexandria, VA 22333-5600): US Army Research Institute.
- PublicVR (2008). <http://publicvr.org>
- Qi, H., & Gilbert, J., Brewer, J. (2002). *Using Animated Pedagogical Agents to Teach Entomology*. World Conference on E-Learning in Corp., Govt., Health., & Higher Ed.
- Raalte, S. V., Kallman, R., Wikstrom, T. (2003). *A Cultural Heritage Dialogue; IT Support for Reflections on the Present and the Future*. Computer Applications and Quantitative Methods in Archaeology, Vienna
- Radjlich, P. (2004). *Vizbox, Inc.*, <http://www.visbox.com/>
- Räihä, K. J. (1997). *Review of Virtual Communities*, <http://www.cs.uta.fi/~kjr/ACHCI/tang.html>
- Rich, E. (1989). Stereotypes and User Modeling. In Wahlster, A. K. A. W. (Ed.), *User Models in Dialog Systems* (pp. 35-51): Springer Verlag
- Roehl, D. B. (1997). *Virtual archeology. Bring new life to ancient worlds*. Innovation, 28 - 35.
- Rose, H. (1996). *Design and Construction of a Virtual Environment for Japanese Language Instruction*. Unpublished Master's, University of Washington.

- Roussos, M., Johnson, A. Moher, T., Leigh, J., Vasilakis C., Barnes, C. (1997a). *The NICE project: Narrative, Immersive, Constructionist/Collaborative Environments for Learning in Virtual Reality*. ED-MEDIA/ED-TELECOM 1997
- Roussos, M. (1997b). *Issues in the Design and Evaluation of a Virtual Reality Learning Environment*. Unpublished Master's thesis, University of Illinois, Chicago.
- Roussos, M. (2004). Personal Communication.
- Roussos, M., Johnson, A. Moher, T., Leigh, J., Vasilakis C., Barnes, C. (1999). *Learning and Building Together in an Immersive Virtual World*. Presence, 8(3), 247-263.
- Roussou, M. (2000). *Immersive Interactive Virtual Reality and Informal Education*. ICS-FORTH
- Roussou, M., Oliver, M., & Slater, M. (2006). *The Virtual Playground: an Educational Virtual Reality Environment for Evaluating Interactivity and Conceptual Learning*. Journal of Virtual Reality 10(3-4), Springer, pp. 227-240.
- Roussou, M., Oliver, M., & Slater, M. (2007) *Exploring Activity Theory as a Tool for Evaluating Interactivity and Learning in Virtual Environments for Children*. Journal of Cognition, Technology & Work, Springer, ISSN: 1435-5558 (Print) 1435-5566
- Ruiz, R., Weghorst, S., Savage, J., Oppenheimer, P., Furness, T.A., Dozal, Y. (2002). *Virtual Reality for Archaeological Maya Cities*. UNESCO World Heritage Conference, Mexico City
- Salzman, M. C., Dede, C., Loftin, R. B., Ash, K. (1998). *Using VR's Frames of Reference in Mastering Abstract Information*. Third International Conference on Learning Sciences, Charlottesville, VA
- Salzman, M. C., Dede, C., Loftin, R. B., Chen, J. (1999). *A Model for Understanding How Virtual Reality Aids Complex Conceptual Learning*. Presence: Teleoperators and Virtual Environments, 8(3), 293 - 316.
- Santos, S. R. D., Fraga, L. S., (2002). Using a Multi User Desktop Based Virtual Reality System to Recreate the São Miguel das Missões Ruins. *CyberPsychology & Behaviour*, 5(5), 471-479.
- Satava, R., M., Jones, S. B. (2002). Medical Applications of Virtual Environments. In K. M. Stanney (Ed.), *Handbook of Virtual Environments*: Lawrence Erlbaum Associates, Inc. 0-8058-3270-X
- Schowengerdt, B.T, Seibel, E.J. (2006). *True 3D scanned voxel displays using single and multiple light sources*. Journal of the Society for Information Display, 14(2), 135-143.  
<http://www.hitl.washington.edu/publications/r-2006-34/r-2006-34.pdf>
- Schulman, S. (1999). Virtual Reality Goes to School. *Computer Graphics World*, 22(3).
- SecondLife. (2008). *SecondLife* <http://millisecond's/>, <http://secondlife.com/>
- Sendin, M., Lores, J., Sola, J. (2002). *Making our multi-device architecture applied to the Montsec area heritage adaptive and anticipating*. Workshop Mobile Tourism Support, Pisa
- Sheridan, T. B. (1992). *Telerobotics, Automation, and Human Supervisory Control*. Cambridge, MA: MIT Press. 0262193167
- Siegel, S. (1988). *Nonparametric Statistics*, McGraw-Hill Inc. ISBN 0-07-057357-3

- Shibly, W. C. (1949). Progressive Matrices: A Perceptual Test of Intelligence. *The Third Mental Measurements Yearbook*. O. K. Buros. New Brunswick, Rutgers University Press: 257-259.
- Shneiderman, B. (1996). *The Eyes Have It: A Task by Data Type Taxonomy for Information Visualizations*. IEEE Conference on Visual Languages, Boulder, CO
- Sinclair, P., Martinez, K. (2001, August). *Adaptive Hypermedia in Augmented Reality*. Third Workshop on Hypertext and Hypermedia at the Twelfth ACM Conference on Hypertext and Hypermedia, Aarhus, Denmark
- Shrout, P. E., Fleiss, J. L. (1979) *Intraclass Correlations: Uses in Assessing Rater Reliability*. 86(2), p420-428.
- Slater, M. (1999). *Measuring Presence: A Response to the Witmer and Singer Presence Questionnaire*. Presence: Teleoperators and Virtual Environments, 8(5), pp 560-565.
- Softimage. (2001). *Softimage Enhances Runtime Technology With Support For Elumens' Display*, [http://www.softimage.com/Corporate/Press/PressReleases/010322\\_elumens.htm](http://www.softimage.com/Corporate/Press/PressReleases/010322_elumens.htm)
- Specht, M., Weber G., Heitmeyer, S., Schoch, V. (1997). *AST: Adaptive WWW-Courseware for Statistics. Adaptive Systems and User Modeling on the World Wide Web*, Sixth International Conference on User Modeling, Chia Laguna, Sardinia
- Specht, M., Oppermann, R. (1999b, September 27 - October 1, 1999). *User Modeling and Adaptivity in Nomadic Information Systems*. Proceedings of the 7.GI-Workshop Adaptivität und Benutzermodellierung in Interaktiven Softwaresystemen (ABIS99), Universität Magdeburg
- Spice, B. (2004, Sunday, Dec. 19). Computer modeling lets scientists make virtual re-creations of ancient people, things. *Pittsburgh Post Gazette*.
- Spring, M. (1992). Virtual Reality and Abstract Data: Virtualizing Information. *Virtual Reality World*, 1(1).
- Srinivasa, G. R. (2003). *FPS VR*, <http://www.cfar.umd.edu/~gsrao/FPSVR.html>
- Squire, K. (2002). "Video Games in Education." *International Journal of Intelligent Simulations and Gaming* 2(1).
- Stang, B. (2003). *Game Engines features and Possibilities*: Institute of Informatics and Mathematical Modeling @ The Technical University of Denmark <http://www.garagegames.com/uploaded/GameEngines2.pdf>.
- Stanney, K. M. (2002). *Handbook of Virtual Environments*. Mahwah, New Jersey: Lawrence Erlbaum Associates, Inc., Publishers. 0-8058-3270-X
- Stanney, K. M., Zyda, M. (2002b). Virtual Environments in the 20th Century. In *Handbook of Virtual Environments*. Mahwah, New Jersey: Lawrence Erlbaum Associates, Inc., Publishers. 0-8058-3270-X
- Squire, K. D., Jenkins, H. (2003). Harnessing the Power of Games in Education, *Insight*, (3)5
- Stone, R., Ojika, T. (2002). Virtual Heritage: What Next? *IEEE Multimedia*, 73-74.
- Squire, K. D. (2007). Games, Learning and Society: Building a Field, *Educational Technology*

- Tam, S. (2004). *The 3D Bible Project*, <http://www3.telus.net/public/kstam/en/default.htm>
- Tan, S., Tan, L. (1997). CHEMMAT: Adaptive Multimedia Courseware for Chemistry. *Journal of Science Education and Technology*, 6(1).
- Tennant, S., Kock, C., Palakal, M., Rogers, J., Baker, M. P. (2003, October). *Negotiating Virtual and Physical Museum Space*. Virtual Systems and MultiMedia, Montreal
- There. (2008). *There* <http://www.there.com>
- TimeRef. (2004). *TimeRef* <http://www.timeref.com/>
- TombRaider (2008). [http://en.wikipedia.org/wiki/Tomb\\_Raider](http://en.wikipedia.org/wiki/Tomb_Raider)
- Torre, I. (2001). Goals, Tasks and Application Domains as the Guidelines for Defining a Framework for User Modeling. In *User Modeling 2001, Lecture Notes in Computer Science* (pp. 260-262): Springer Verlag
- Tougaw, D., Will, J. (2003). Visualizing the Future of Virtual Reality. *Computing in Science & Engineering*, 5(4 ), 8-11.
- TrajanForum. (1999). *The Forum of Trajan in Rome*, <http://www.getty.edu/artsednet/Exhibitions/Trajan/index.html>
- TroiaVR. (2003). *TroiaVR*, [http://www.uni-tuebingen.de/troia/vr/vr0103\\_en.html](http://www.uni-tuebingen.de/troia/vr/vr0103_en.html)
- TutTomb. (2001). *Take a virtual tour of the Tomb of Tutankhamun*, <http://www.civilization.ca/civil/egypt/egqtvvr1e.html>
- Ubersax (2007) <http://ourworld.compuserve.com/homepages/jsuebersax/agree.htm>
- Udine3D. (2004). *Udine 3D*, <http://udine3d.uniud.it/en/index.html>
- Ulicny, B., Thalmann, D. (2002). *Crowd Simulation for Virtual Heritage*. First International Workshop on 3D Virtual Heritage, Geneva
- Valzano, V., Bandiera, A., Beraldin, J. A., Picard, M., El-Hakim, S. F., Godin, G. (2004). *Virtual Heritage: the Cases of the Byzantine Crypt of Santa Cristina and Temple C of Selinunte*. IX Convegno della Associazione Italiana Intelligenza Artificiale, Perugia
- VAST. (2005). *The 5th International Symposium on Virtual Reality, Archaeology and Cultural Heritage*. <http://www.eg.org/EG/DL/WS/VAST/VAST04>
- VeniceCharter. (2004). *The Venice Charter; International Charter for the Conservation and Restoration of Monuments and sites*, [http://www.international.icomos.org/e\\_venice.htm](http://www.international.icomos.org/e_venice.htm)
- VHN. (2004). *Virtual Heritage Network*, <http://www.virtualheritage.net/>
- ViHAP3D. (2004). *Virtual Heritage: High Quality Acquisition and Presentation*, <http://www.vihap3d.org/project.html>
- VirtualArcheology. (2004). *Virtual Archeology*, <http://www.mnsu.edu/emuseum/archaeology/virtual/>
- Viz-Tek. (2004). *Virtual Walls™*, <http://www.viz-tek.com/PCWall.html>

- VRheritage. (2004). *VR Heritage*, <http://vrheritage.org>
- VSMM. (2004). *International Society of Virtual Systems and MultiMedia*, <http://www.vsmm.org/>
- VWAI. (2004). *Virtual Worlds in Archeology*, [http://www.learningsites.com/VWinAI/VWAI\\_home.htm](http://www.learningsites.com/VWinAI/VWAI_home.htm)
- Vygotsky, L. S. (1978). *Mind in Society: The Development of Higher Psychological Processes*. Cambridge, MA: Cambridge University Press
- Web3D (2004). *XJ3D*, <http://www.web3d.org/x3d/applications/xj3d/index.html>.
- Weber, G., Brusilovsky, P. (2001). ELM-ART: An Adaptive Versatile System for Web-based Instruction. *International Journal of Artificial Intelligence in Education*, 12, 351-384.
- Weis, A. (2004). Personal Communication.
- Welch, G., Foxlin, E. (2002) *Motion Tracking: No Silver Bullet, but a Respectable Arsenal*, IEEE Computer Graphics and Applications, November/December 2002.
- Westby, G. (1953). Progressive Matrices. *The Fourth Mental Measurements Yearbook*. O. K. Buros. Highland Park, NJ, Gryphon Press: 418-422.
- Westwood, J. D., Haluck, R. S., Hoffman, H. M. et al. (2004). *Medicine Meets Virtual Reality 12: Building a Better You: The Next Tools for Medical Education, Diagnosis, and Care*: IOS Press. 1-586-03404-9
- Wexelblat, A. (1991). Giving Meaning to Place: Semantic Spaces. In M. Benedikt (Ed.), *Cyberspace: First Steps* (pp. 255-271). Cambridge, MA: MIT Press. ISBN 0262-02327-X (hb) 0262-52177-6 (pb)
- Wickens, C. D. (1992). *Virtual Reality and Education*. IEEE International Conference on Systems, Man and Cybernetics
- Wickens, C. D., Baker, P. (1995). Cognitive issues in virtual reality. In Barfield, I. W., Furness, T. A. (Ed.), *Virtual Environments and Advanced Interface Design* (pp. 514-541). New York: Oxford University Press
- Williams, M., Gilbert, J., & Madsen, N. (2004). *Nel: An Interactive Physics Tutor*. World Conference on E-Learning in Corp., Govt., Health, & Higher Ed.
- Windschitl, M., Winn, B. (2000). *A Virtual Environment Designed To Help Students Understand Science*. Fourth International Conference of the Learning Sciences.
- Winograd, T. (2000) *Interaction Spaces for 21<sup>st</sup> Century Computing*, in John Carroll, Ed., *HCI in the New Millennium*, Addison Wesley, <http://hci.stanford.edu/~winograd/papers/21st/>
- Winn, W. (1993). *A Conceptual Basis for Educational Applications of Virtual Reality* (R-93-9). Seattle: University of Washington, Human Interface Technology Laboratory, <http://www.hitl.washington.edu/publications/r-93-9/>
- Winn, W. (1997). *The Impact of Three-Dimensional Immersive Virtual Environments on Modern Pedagogy* (Technical Report R-97-15). Seattle: Human Interface Technology Lab, <http://www.hitl.washington.edu/publications/r-97-15/>

- Winn, W. (1997c, May 19-21, 1997). *Learning in Hyperspace*. The Potential of the Web: A Professional Development Workshop for Educators, College Park, MD
- Winn, W. J., R. (1999a). Fourteen propositions about educational uses of virtual reality. *Educational Technology*, 39(4 July/August 1999).
- Winn, W., Windschitl, M., Thomson-Bulldis, A. (1999b). Learning Science in Virtual Environments: A Theoretical Framework and Research Agenda. *Educational Media International*, 36(4), 217-279.
- Winn, W., Windschitl, M., Hedly, N., Postner, L. (2001). *Learning Science in an Immersive Virtual Environment*. Presented at the Annual Meeting of the American Educational Research Association, Seattle, WA
- Winn, W., (2002, May). What Can Students Learn in Artificial Environments That They Cannot Learn in Class? First International Symposium, Open Education Faculty, Anadolu University, Turkey,
- Winn, W., Windschitl, M., Fruland, R., Lee, Y. (2003a). *Features of Virtual Environments that Contribute to Learners' Understanding of Earth Science*. Annual Meeting of the National Association for Research in Science Teaching, New Orleans
- Winn, W. (2003b). Learning in Artificial Environments: Embodiment, Embeddedness and Dynamic Adaptation. *Tech., Inst., Cognition and Learning*, 1, 87-114.
- Witmer, B., Singer, M. (1998b). Measuring Presence in Virtual Environments: A Presence Questionnaire. *Presence Teleoperators and Virtual Environments*, 7(3), 225-240.
- Young, J. R. (2000, October, 6). Virtual Reality on a Desktop Hailed as New Tool in Distance Education. *Chronicle of Higher Education*, <http://chronicle.com/free/v47/i06/06a04301.htm>.
- Youngblut, C. (1998). Educational Uses of Virtual Reality (No. IDA Document Report Number D-2128, Log: H 98-000105): Alexandria, VA: Institute for Defense Analysis.
- Zara, J., Slavik, P. (2003). *Cultural Heritage Presentation in Virtual Environment: Czech Experience*. From Proceedings of the Fourteenth International Workshop on Database and Expert Systems Applications.. Prague. 0-7695-1993-8
- Zeltzer, D. (1992). *Autonomy, Interaction and Presence*. *Presence: Teleoperators & Virtual Environments*, 1(1), p 127-232.
- Zhang, J. (2001). External representations in complex information processing tasks. In. Williams, A. K. J. G. (Ed.), *Encyclopedia of Microcomputers*. New York: Marcel Dekker, Inc.
- Zheng, J. Y. (2000). Virtual Recovery and Exhibition of Heritage. *IEEE Multimedia*.